

Relatives of Isaac Sears

Compiled by Leslie Sears
Moore, USA
10th November 2020

Compiled by Leslie Sears

Copyright 2020 by Leslie Sears

All rights reserved. No part of this publication may be reproduced or transmitted in any form or by any means, electronic or mechanical, including photocopy, recording or any information storage on retrieval system, without permission in writing from the copyright owner.

A comparatively modest present,
but the good ones which I can give.

"Only who knows his past has a future."
Wilhelm von Humboldt (1767-1835)

Foreword

This book contains the facts, who, where, when, but not the story of our family. If you can add to our history or have an anecdote to tell, then please share it and help make our story come alive. Even little things, like your cousin the fisherman who didn't eat fish, will make our story more personal. If you can add to our story, please contact me! I hope to have at least a photo of everyone who is here. It is amazing how often there is a close resemblance for relatives separated by generations.

Leslie Sears
Moore, USA
10th November 2020

Contents

Introduction.....	11
Families of the Starting Person.....	13
Isaac Sears.....	13
Isaac Sears and Polly Woods.....	14
Isaac Sears and Abigail Andrews.....	15
Related 1 Step Removed.....	17
Parents.....	17
Knowles Sears.....	17
Knowles Sears and Charity Haviland.....	18
Knowles Sears and Susanna Townsend.....	20
Siblings.....	23
Daniel Sears and Catharine Warin.....	23
Betty Sears and Nathan Hawley.....	25
Susanna Sears and Heman Sears.....	28
Mary Sears.....	29
Mary Sears and Elijah Benedict.....	30
Mary Sears and Isaac Townsend.....	31
Mary Sears and Forward Stevens.....	31
John Sears.....	32
John Sears and Mary Townsend.....	33
John Sears and Phebe Lusk.....	34
Abijah Sears.....	35
Abijah Sears and Anna Browne.....	36
Abijah Sears and Catharine Boughton.....	37
Abijah Sears and Sally Hendricks.....	38
Desire Sears and Caleb Gregory.....	39
Charles Sears and Betsy Smith.....	41
Charity Sears and Stephen Crosby.....	43
Elizabeth Sears and Joseph Brush.....	44
David Sears and Sally Morris.....	46
Children.....	49
Angeline Sears and Ebenezer Jones.....	49
Ruhamah Sears and Noah Sherwood.....	51
Haman Sears and Ann Moore.....	55
Heman Sears and Clarissa DuBois.....	57
Related 2 Steps Removed.....	59
Grandparents.....	59
James Sears and Desire Tobey.....	59
Uncles/aunts.....	63
David Sears and Mary Paddock.....	63
Sarah Sears and Reuben Crosby.....	66
Thankful Sears and James Foster.....	68
Seth Sears and Sarah Sears.....	69
Thomas Sears and Deborah Baldwin.....	71
Desire Sears and Timothy Foster.....	73
James Sears and Elizabeth Olmstead.....	74
Rebecca Sears and Eli Crosby.....	77
Comfort Sears and Eunice Crane.....	78
1st Cousins.....	83
Bethia Sears and Jacob Goodrich.....	83
Philip Sears and Lavina Gunn.....	84
David Sears and Huldah Carr.....	87
Isaac Sears.....	89
Isaac Sears and Priscilla Stearns.....	90
Isaac Sears.....	91
Calvin Sears.....	92

Calvin Sears and Mary Hubby	92
Calvin Sears and Isabell --Sears	94
Luther Sears and Anna Foster	95
Elizabeth Sears and Robert McKnight	100
James Sears and Lucy Judd	102
Polly Sears and Robert McKnight	105
Zachariah Sears	105
Zachariah Sears and Sally Hall	106
Zachariah Sears and Almira Butler	108
James Crosby and Deborah Paddock	111
Tertullus Crosby and Elizabeth Jones.....	112
Mary Foster and Obadiah Crosby	113
Enoch Sears and Smith	114
Naomi Sears and Zadoc(k) Rider	116
Sarah Sears and Zacheus Raymond	119
Seth Sears.....	121
Seth Sears and Eunice Paddock	122
Seth Sears and Ruhamah Andrews.....	123
Eleazar Sears and Betsy Marvin.....	124
Thankful Sears and William Smith.....	128
Eli Sears and Hanna Bull.....	130
Thomas Sears and Sally Lewis.....	133
James Sears	133
James Sears and Phebe --Sears.....	135
James Sears and Mehitabel Sherwood	136
James Sears and Lucretia Munsell	139
Archibald Sears and Polly Sellick.....	140
Sophia Sears and Archibald Young	143
Isaac Sears and Mary Sears	144
Deborah Sears	146
Deborah Sears and Ludington	147
Deborah Sears and Craft	147
Sally Sears and Ezra Young	148
Huldah Sears and Isaac Brownson	150
Nathan Sears and Sybil --Sears.....	151
Hezekiah Sears and Roxana --Sears	152
Thirza Sears and Ephraim Hawley.....	154
Lyman Sears and Hannah Sager.....	155
Jared Sears and Betsy Robinson	160
Betsy Sears and Joseph Montague.....	163
Millicent Sears and Bradley Castle	165
Eber Crosby and Esther Raymond.....	167
Thirza Sears and William Sears	168
Esther Sears and Jeremiah Griffiths	174
Desire Sears and Czar Benedict.....	176
Eunice Sears and James Weed	177
Camilla Sears and Elijah Crosby	178
James Sears	179
James Sears and Charity White	179
James Sears and Deborah Crosby	180
Joseph Sears	185
Joseph Sears and Patty Barnum	186
Joseph Sears and Mary Brush.....	188
Lewis Sears and Sarah Crosby	191
Polly Sears and Nehemiah Perry	195
Nephews/nieces	197
Arza Sears and Elizabeth Betts.....	197
Ambrose Sears and Ruth --Sears.....	201
Ahiram Sears and Ann Bell	203
Ruhamah Sears and Judge Barager.....	207
Rufus Sears and Amanda Townsend.....	209
Maria Sears and Asa Bushnell	210

George Hawley and Matilda Warner	211
Ezra Benedict	212
Ezra Benedict and Atha Sears	213
Ezra Benedict and Rebecca Beebe	215
Tamma Sears and John Lamerson	217
Hannah Sears and Cyrus Kingsley	219
John Sears and Phebe Cook	224
James Sears and Matilda Cartwright	227
Charles Sears and Clarissa Tabor	230
Mary Sears and Oliver Rewey	231
Hart Sears and Cynthia Williams	232
Gregory and Levi Benedict	239
Adeline Gregory and James St. John	240
Edwin Sears and Marietta Jarvis	242
George Sears and Sarah Gregory	244
Ruth Crosby and Roderick Price	250
Mary Crosby and Joseph Beebe	251
Charity Brush and Drum	252
Knowles Brush and Elizabeth Meeker	253
Charlotte Brush	254
Charlotte Brush and David Col	255
Charlotte Brush and Myron Barnes	256
Mary Brush and Gordon Tracy	256
Ann Brush and John Benedict	257
William Brush and Sabra Wood	258
Grandchildren	259
Abel Sherwood and Mary Durst	259
Elam Sherwood and Susannah Dewhurst	260
Jones Sherwood and Frances Hibbard	261
John Sherwood and Mary Hess	264
Myron Sherwood and Emily Spalding	265
Mary Sherwood and Roxanna Putnam	268
Angeline Sherwood and William Hyde	269
Abigail Sears and James Corwin	271
Isaac Sears and Hannah Sweet	272
Mary Sears and James Christy	281
Sophia Sears and Ammi Smith	284
Polly Sears and Emory Lewis	286
Hester Sears	287
Hester Sears and Morgan van Wagoner	288
Hester Sears and Charles Shaw	289
Haman Sears and Marcena Strong	290
Bibliography	293
Index of Places	299
Index of Individuals	317

Introduction{ TC "Introduction" \f C}

The following pages list data for all known family members as of 10th November 2020.

Each immediate family is presented in their own section that contains a graphical family tree as well as a description with information about each referenced person and their children. The child section provides information about the children of the preceding couple. When a child has offspring of their own this is presented in a separate family section for that child. In this case a '+' is used to denote that an individual will appear later in the book as a parent with his/her own children and there is a link to the appropriate family reference number. For children with partners but no offspring the partner data is given with the reference family. Roman numerals, followed by a period, are used to indicate the birth order.

In the chapter titled "Families of the Starting Person" the ancestors of Isaac Sears are presented in a kind of enhanced Pedigree Chart which displays the graphic representation of their direct-line ancestors and the children of the couple. This chapter contains information about the couple whose relatives are listed in the later chapters.

The chapter titled "Families of his Ancestors" provides details (as known as of the publication date) for the relatives of Isaac Sears. There is a chapter for each generation. Relatives are listed in the order of the nearness of their relationship.

Sources for the information provided are given in the footnotes.

This document reports the details of 813 individuals, of whom 393 are male and 418 are female. The sex of 2 individuals is unknown. Of the 501 individuals with recorded birth and death dates, the average lifespan was 49.45 years. Of these, 251 males averaged 64.5 years, and 249 females averaged 34.36 years. The longest living male was James Sears (1822–1923), who died aged 100. The longest living female was Desire Sears (1778–1879), who died aged 100.

Families of the Starting Person{ TC "Families of the Starting Person" \f C}

Isaac Sears{ TC "Isaac Sears" \I 3 \f C}

1. **Isaac⁶ Sears**{ XE "Sears:Isaac (1776–1848)" \f "Name" \b } (Knowles⁵, James⁴, Silas³, Silas², Richard¹) was born on Wednesday, 7th August 1776, in Danbury, Fairfield, Connecticut, USA{ XE "USA, Connecticut, Fairfield, Danbury:(41.3948° N, 73.454° W):Sears, Isaac (1776–1848)" \f "Place" }.^[1, 2-3] He was the son of Knowles Sears{ XE "Sears:Knowles (1738–1817)" \f "Name" \i } (4) and Susanna Townsend{ XE "Townsend:Susanna (1740–1782)" \f "Name" \i } (6).

Isaac died on 20th September 1848, at the age of 72. He was buried in Olcott{ XE "USA, New York, Niagara, Olcott:(43.3378° N, 78.7148° W):Sears, Isaac (1776–1848)" \f "Place" }.

!S.P. May p.278 Isaac was a farmer, and settled in Newfane, Niagra co., NY

<https://www.wikitree.com/wiki/Sears-3946>

Probate records-

https://www.ancestry.com/interactive/8800/005116459_00456?pid=2533950&backurl=https://search.ancestry.com/cgi-bin/sse.dll?db%3D8800%26h%3D2533950%26indiv%3Dtry&treeid=&personid=&hintid=&usePUB=true&usePUBJs=true 23 Oct 1848 Heman Sears and Noah Sherwood (husband of Ruhamah but she is not mentioned in letters testamentary)

More facts and events for Isaac Sears:

Residence: 1810 Redding, Fairfield, Connecticut{ XE "USA, Connecticut, Fairfield, Redding:(41.3025° N, 73.3839° W):Sears, Isaac (1776–1848)" \f "Place" }^[3]

Residence: 1840 Newfane, Niagara, New York{ XE "USA, New York, Niagara, Newfane:(43.2867° N, 78.7103° W):Sears, Isaac (1776–1848)" \f "Place" }^[2]

Marriages with Polly Woods and Abigail Andrews (Page 15) are known.

¹ Edmund West, comp., Family Data Collection - Individual Records (Provo, UT, USA, Ancestry.com Operations Inc, 2000), Ancestry.com, Birth year: 1776; Birth city: Danbury; Birth state: CT.

² Ancestry.com, 1840 United States Federal Census (Provo, UT, USA, Ancestry.com Operations, Inc., 2010), Ancestry.com, Year: 1840; Census Place: Newfane, Niagara, New York; Roll: 311; Page: 129; Family History Library Film: 0017199. [Source citation includes one media item]

³ Ancestry.com, 1810 United States Federal Census (Provo, UT, USA, Ancestry.com Operations, Inc., 2010), Ancestry.com, Year: 1810; Census Place: Redding, Fairfield, Connecticut; Roll: 1; Page: 291; Image: 00294; Family History Library Film: 0281229. [Source citation includes one media item]

Family of Isaac Sears and Polly Woods{ TC "Isaac Sears and Polly Woods" \I 4 \f C}

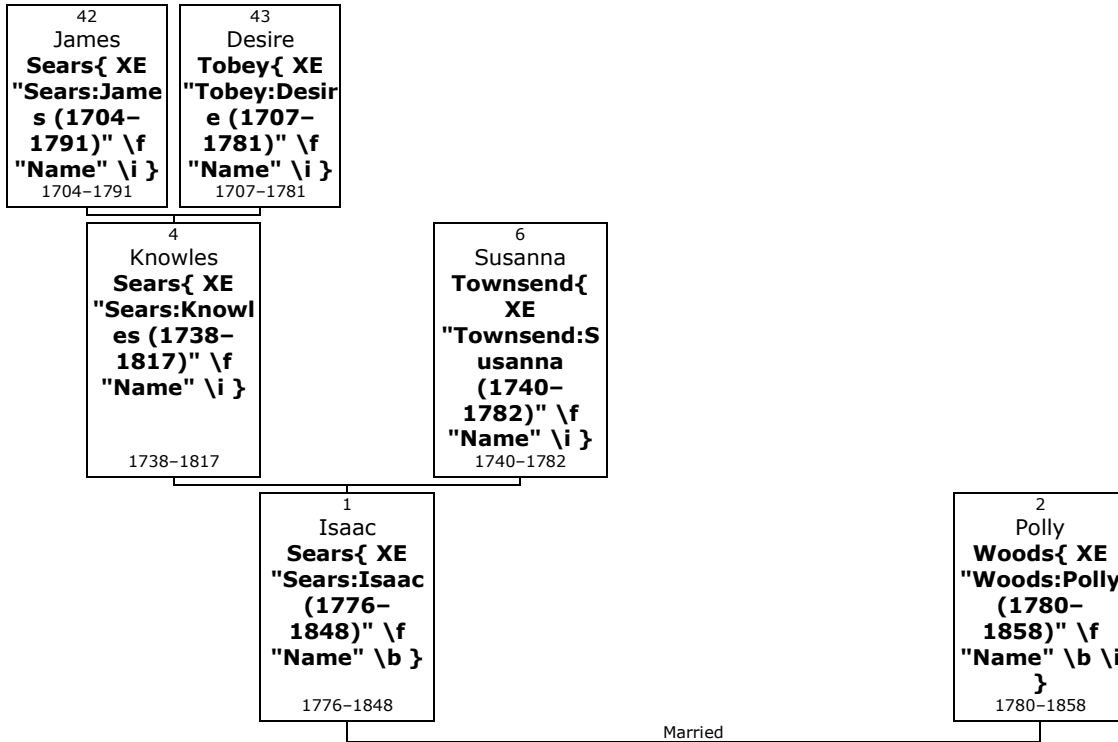

Here are the details about **Isaac Sears**{ XE "Sears:Isaac (1776-1848)" \f "Name" \b } first marriage, with Polly Woods. You can read more about Isaac on page 13.

2. Isaac Sears married **Polly Woods**{ XE "Woods:Polly (1780-1858)" \f "Name" \b \i }. They had no known children.

Polly was born in perh, Danbury,{ XE "USA, Connecticut, Fairfield, Danbury, perh: :Woods, Polly (1780-1858)" \f "Place" } in 1780. She reached 78 years of age and died on 27th June 1858. D.S.P. Polly was buried in Olcott, Niagara, New York,{ XE "USA, New York, Niagara, Olcott:(43.3378° N, 78.7148° W):Woods, Polly (1780-1858)" \f "Place" }.

Isaac Sears and Abigail Andrews{ TC "Isaac Sears and Abigail Andrews" \I 4 \f C}

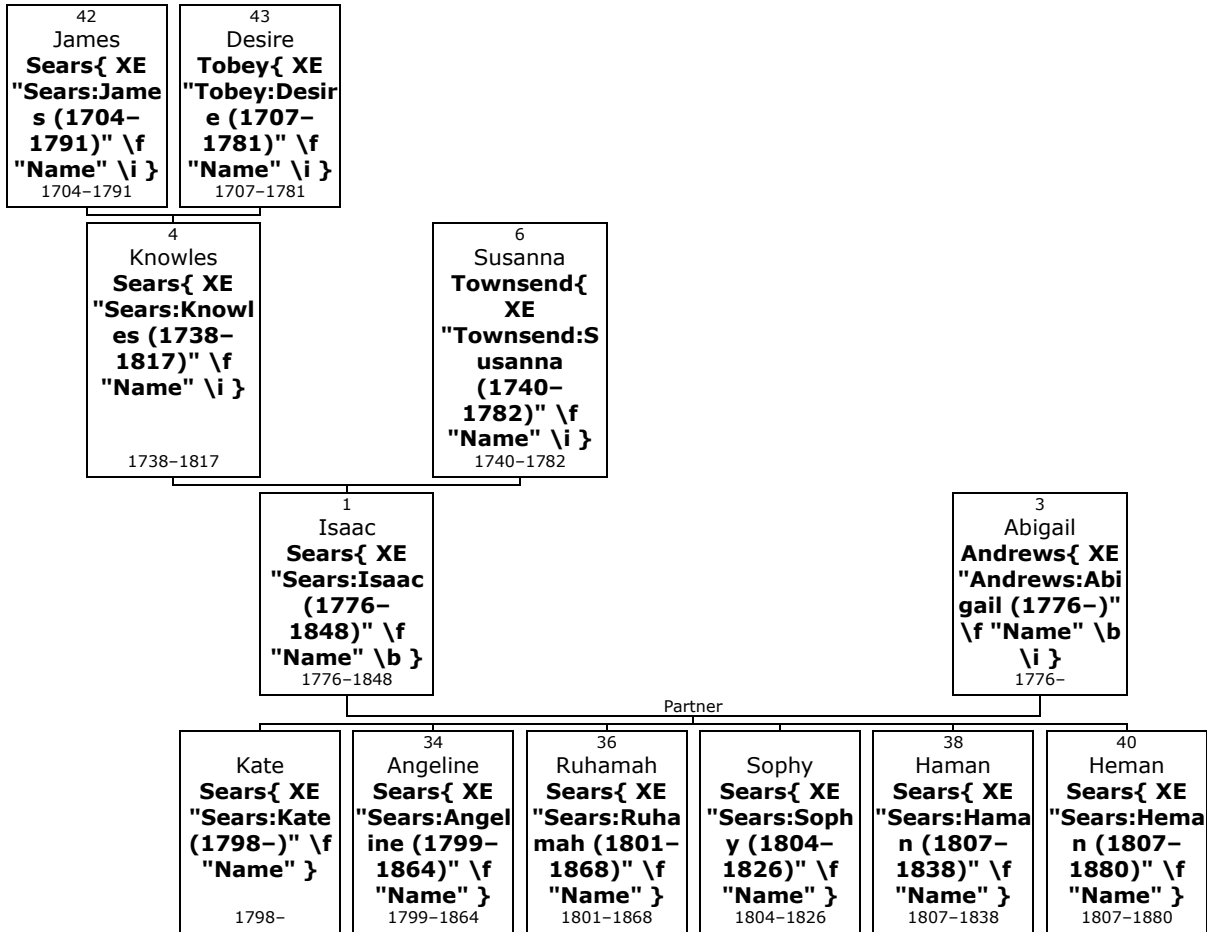

Here are the details about **Isaac Sears**{ XE "Sears:Isaac (1776-1848)" \f "Name" \b } second relationship, with Abigail Andrews. You can read more about Isaac on page 13.

3. Isaac Sears was partnered with **Abigail Andrews**{ XE "Andrews:Abigail (1776-)" \f "Name" \b \i }. They had six children: Kate (1798-), Angeline (1799-1864), Ruhamah (1801-1868), Sophy (1804-1826), Haman (1807-1838) and Heman (1807-1880).

Abigail was born in perh, Danbury,{ XE "USA, Connecticut, Fairfield, Danbury, perh: :Andrews, Abigail (1776-)" \f "Place" } in 1776.

Children of Isaac Sears and Abigail Andrews:

- f I. **Kate⁵ Sears**{ XE "Sears:Kate (1798-)" \f "Name" \b } was born in perh{ XE "USA, Connecticut, Fairfield, Danbury, perh: :Sears, Kate (1798-)" \f "Place" } in 1798.
- + 34 f II. **Angeline Sears**{ XE "Sears:Angeline (1799-1864)" \f "Name" } was born in perh{ XE "USA, Connecticut, Fairfield, Danbury, perh: :Sears, Angeline (1799-1864)" \f "Place" } in 1799.^[4] She died in Ballston Spa, Saratoga, New York,{ XE "USA, New York, Saratoga, Ballston Spa:(43.0009° N, 73.849° W):Sears, Angeline (1799-1864)" \f "Place" } on 11th January 1864, at the age of 65.^[4]
- + 36 f III. **Ruhamah Sears**{ XE "Sears:Ruhamah (1801-1868)" \f "Name" } was born in Clarkson, Monroe, New York,{ XE "USA, New York, Monroe, Clarkson:(43.2331° N, 77.9278° W):Sears, Ruhamah (1801-1868)" \f "Place" } on 31st May 1801.^[4] She died in Niagara{ XE "USA, New York, Niagara:(43.3239° N, 78.7939° W):Sears, Ruhamah (1801-1868)" \f "Place" } on 19th June 1868, at the age of 67.^[4]
- f IV. **Sophy Sears**{ XE "Sears:Sophy (1804-1826)" \f "Name" \b } was born in perh, Danbury, Fairfield, Connecticut,{ XE "USA, Connecticut, Fairfield, Danbury, perh: :Sears,

⁴ Ancestry.com, U.S., Find A Grave Index, 1600s-Current (Provo, UT, USA, Ancestry.com Operations, Inc., 2012), Ancestry.com.

Sophy (1804–1826)" \f "Place" } in 1804.^[5] She died in Connecticut{ XE "USA, Connecticut:(41.5735° N, 72.7383° W):Sears, Sophy (1804–1826)" \f "Place" } on 17th August 1826, at the age of 22.^[5] Sophy was buried in Bogg's District, Danbury, Fairfield, Connecticut{ XE "USA, Connecticut, Fairfield, Danbury, Bogg's District: :Sears, Sophy (1804–1826)" \f "Place" }.

+ 38 m

V. **Haman Sears**{ XE "Sears:Haman (1807–1838)" \f "Name" } was born in Newfane, Niagara, New York,{ XE "USA, New York, Niagara, Newfane:(43.2867° N, 78.7103° W):Sears, Haman (1807–1838)" \f "Place" } on 23rd May 1807. He died in Olcott{ XE "USA, New York, Niagara, Olcott:(43.3378° N, 78.7148° W):Sears, Haman (1807–1838)" \f "Place" } on 21st February 1838, at the age of 30.

+ 40 m

VI. **Heman Sears**{ XE "Sears:Heman (1807–1880)" \f "Name" } was born in perh, Danbury, Fairfield, Connecticut,{ XE "USA, Connecticut, Fairfield, Danbury, perh: :Sears, Heman (1807–1880)" \f "Place" } on 23rd May 1807.^[4, 6] He died in Newfane, Niagara, New York,{ XE "USA, New York, Niagara, Newfane:(43.2867° N, 78.7103° W):Sears, Heman (1807–1880)" \f "Place" } on 14th January 1880, at the age of 72.^[4, 6]

⁵ Ancestry.com, Connecticut, Deaths and Burials Index, 1650-1934 (Provo, UT, USA, Ancestry.com Operations, Inc., 2011), Ancestry.com.

⁶ Ancestry.com, New York, U.S. Census Mortality Schedules, 1850-1880 (Provo, UT, USA, Ancestry.com Operations, Inc, 2010), Ancestry.com, U.S. Census Mortality Schedules, New York, 1850-1880; New York State Education Department, Office of Cultural Education; Albany, New York; Year: 1880; Roll: M13; Line Number: 5.

Related 1 Step Removed{ TC "Related 1 Step Removed" \f C}

Parents{ TC "Parents" \I 2 \f C}

Knowles Sears{ TC "Knowles Sears" \I 3 \f C}

4. **Capt Knowles³ Sears**{ XE "Sears:Knowles (1738-1817)" \f "Name" \b } (*James*²) was born in 1738 in Ridgefield, Fairfield, Connecticut, USA{ XE "USA, Connecticut, Fairfield, Ridgefield:(41.2815° N, 73.4982° W):Sears, Knowles (1738-1817)" \f "Place" },^[7, 8, 9, 10, 11, 12, 13, 14, 15, 16, 17-18] He was the son of James Sears{ XE "Sears:James (1704-1791)" \f "Name" \i } (42) and Desire Tobey{ XE "Tobey:Desire (1707-1781)" \f "Name" \i } (43).

Knowles died in Ridgefield, Fairfield, Connecticut,{ XE "USA, Connecticut, Fairfield, Ridgefield:(41.2815° N, 73.4982° W):Sears, Knowles (1738-1817)" \f "Place" } on 17th June 1817, at the age of 79.^[9-13, 16] He was buried in Milltown Cemetery, Southeast, Putnam, New York{ XE "USA, New York, Putnam, Southeast, Milltown Cemetery: :Sears, Knowles (1738-1817)" \f "Place" }.^[9, 11]

<https://www.wikitree.com/index.php?title=Sears-881>

!S.P. May, No 298, Capt Knowles Sears, as he is styled in the records, lived and died on the farm adjoining his father's at Ridgefield, CT, and was buried with his wives in Milltown Cemetery near Brewster, NY. [35-11-17]

!

!VTL He enlisted in 1779 in the CT line. Saw service in Westchester co, NY, 7 Jun 1779. He was Capt of a militia company in Col Beardsley's Regt that turned out to repel Tryon's invasion. Susannah did valuable service by carrying, on horseback, messages across the lines. She died of smallpox.

!

!Colonial Records of CT, Oct 1775, p.156, This Assembly do establish Knowles Sears to be Lieutenant of the eighth company or trainband in the 16th Regiment of this Colony.

-
- ⁷ Godfrey Memorial Library, comp., American Genealogical-Biographical Index (AGBI) (Provo, UT, USA, Ancestry.com Operations Inc, 1999), Ancestry.com.
- ⁸ Edmund West, comp., Family Data Collection - Births (Provo, UT, USA, Ancestry.com Operations Inc, 2001), Ancestry.com.
- ⁹ Ancestry.com, U.S., Find A Grave Index, 1600s-Current (Provo, UT, USA, Ancestry.com Operations, Inc., 2012), Ancestry.com.
- ¹⁰ Ancestry.com, U.S., Sons of the American Revolution Membership Applications, 1889-1970 (Provo, UT, USA, Ancestry.com Operations, Inc., 2011), Ancestry.com. [Source citation includes one media item]
- ¹¹ Ancestry.com, Connecticut, Hale Cemetery Inscriptions and Newspaper Notices, 1629-1934 (Provo, UT, USA, Ancestry.com Operations, Inc., 2012), Ancestry.com. [Source citation includes one media item]
- ¹² Ancestry.com, Connecticut, Deaths and Burials Index, 1650-1934 (Provo, UT, USA, Ancestry.com Operations, Inc., 2011), Ancestry.com.
- ¹³ Edmund West, comp., Family Data Collection - Deaths (Provo, UT, USA, Ancestry.com Operations Inc, 2001), Ancestry.com.
- ¹⁴ Ancestry.com, 1810 United States Federal Census (Provo, UT, USA, Ancestry.com Operations, Inc., 2010), Ancestry.com, Year: 1810; Census Place: Redding, Fairfield, Connecticut; Roll: 1; Page: 291; Image: 00294; Family History Library Film: 0281229. [Source citation includes one media item]
- ¹⁵ Ancestry.com, Connecticut Revolutionary War Military Lists, 1775-83 (Provo, UT, USA, Ancestry.com Operations Inc, 1999), Ancestry.com.
- ¹⁶ Ancestry.com, Connecticut, Church Record Abstracts, 1630-1920 (Provo, UT, USA, , 2013), Ancestry.com. [Source citation includes one media item]
- ¹⁷ Ancestry.com, 1800 United States Federal Census (Provo, UT, USA, Ancestry.com Operations Inc, 2010), Ancestry.com, Year: 1800; Census Place: Ridgefield, Fairfield, Connecticut; Series: M32; Roll: 1; Page: 78; Image: 49; Family History Library Film: 205618. [Source citation includes one media item]
- ¹⁸ Ancestry.com, 1790 United States Federal Census (Provo, UT, USA, Ancestry.com Operations, Inc., 2010), Ancestry.com, Year: 1790; Census Place: Ridgefield, Fairfield, Connecticut; Series: M637; Roll: 1; Page: 296; Image: 302; Family History Library Film: 0568141. [Source citation includes one media item]

!
!DAR #36914-entered into the army as an ensign and at the New Haven Alarm, commanded a company.
More facts and events for Knowles Sears:

- Residence: 1790 Ridgefield, Fairfield, Connecticut{ XE "USA, Connecticut, Fairfield, Ridgefield:(41.2815° N, 73.4982° W):Sears, Knowles (1738–1817)" \f "Place" }^[18]
- Residence: 1800 Ridgefield{ XE "USA, Connecticut, Fairfield, Ridgefield:(41.2815° N, 73.4982° W):Sears, Knowles (1738–1817)" \f "Place" }^[17]
- Residence: 1810 Redding{ XE "USA, Connecticut, Fairfield, Redding:(41.3025° N, 73.3839° W):Sears, Knowles (1738–1817)" \f "Place" }^[14]
- Residence: Connecticut{ XE "USA, Connecticut:(41.5735° N, 72.7383° W):Sears, Knowles (1738–1817)" \f "Place" }^[15]

Marriages with Charity Haviland and Susanna Townsend (Page 20) are known.

Family of Knowles Sears and Charity Haviland{ TC "Knowles Sears and Charity Haviland" \I 4 \f C}

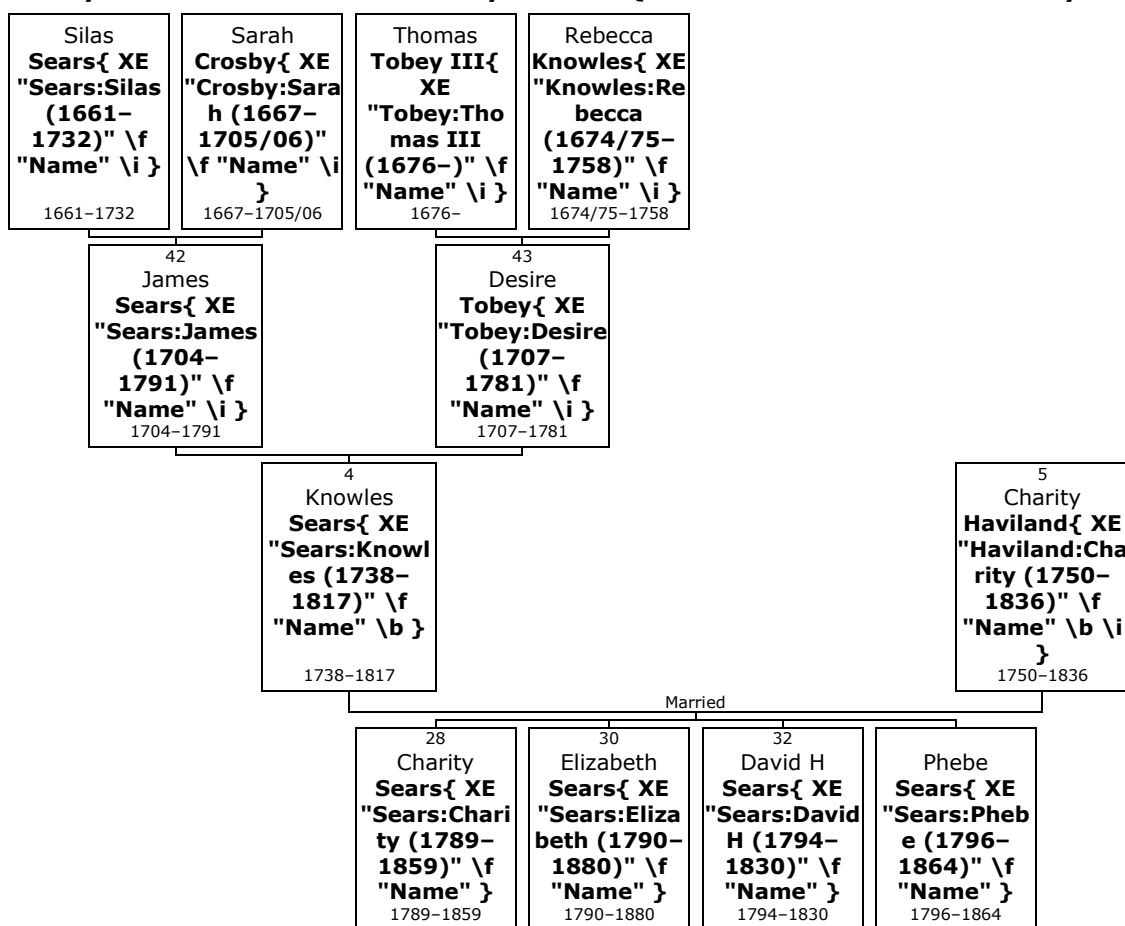

Here are the details about **Knowles Sears**{ XE "Sears:Knowles (1738–1817)" \f "Name" \b } first marriage, with Charity Haviland. You can read more about Knowles on page 17.

5. Capt Knowles Sears married **Charity Haviland**{ XE "Haviland:Charity (1750–1836)" \f "Name" \b \i }.^[9] They had four children: Charity (1789–1859), Elizabeth (1790–1880), David (1794–1830) and Phebe (1796–1864).

Charity was born in Ridgefield{ XE "USA, Connecticut, Fairfield, Ridgefield:(41.2815° N, 73.4982° W):Haviland, Charity (1750–1836)" \f "Place" } in 1750.^[9] She reached 86 years of age and died in Danbury{ XE "USA, Connecticut, Fairfield, Danbury:(41.3948° N, 73.454° W):Haviland, Charity (1750–1836)" \f "Place" } on 18th September 1836.^[9] Charity was buried in Brewster, Putnam, New York{ XE

"USA, New York, Putnam, Brewster:(41.3973° N, 73.6171° W):Haviland, Charity (1750–1836)" \f "Place" }.^[9]

<https://www.wikitree.com/wiki/Haviland-302>

Children of Knowles Sears and Charity Haviland:

- + 28 f I. **Charity^d Sears**{ XE "Sears:Charity (1789–1859)" \f "Name" } was born in Ridgefield, Fairfield, Connecticut,{ XE "USA, Connecticut, Fairfield, Ridgefield:(41.2815° N, 73.4982° W):Sears, Charity (1789–1859)" \f "Place" } on 14th August 1789.^[9] She died in Grand Rapids, Kent, Michigan,{ XE "USA, Michigan, Kent, Grand Rapids:(42.9634° N, 85.6681° W):Sears, Charity (1789–1859)" \f "Place" } in 1859 at the age of 69.^[9]
- + 30 f II. **Elizabeth Sears**{ XE "Sears:Elizabeth (1790–1880)" \f "Name" } was born in Ridgefield{ XE "USA, Connecticut, Fairfield, Ridgefield:(41.2815° N, 73.4982° W):Sears, Elizabeth (1790–1880)" \f "Place" } on 26th November 1790.^[9] She died in 1880 at the age of 89.^[9]
- + 32 m III. **David H Sears**{ XE "Sears:David H (1794–1830)" \f "Name" } was born in Ridgefield{ XE "USA, Connecticut, Fairfield, Ridgefield:(41.2815° N, 73.4982° W):Sears, David H (1794–1830)" \f "Place" } in 1794. He died in Danbury{ XE "USA, Connecticut, Fairfield, Danbury:(41.3948° N, 73.454° W):Sears, David H (1794–1830)" \f "Place" } on 26th September 1830, at the age of 36.
- f IV. **Phebe Sears**{ XE "Sears:Phebe (1796–1864)" \f "Name" \b } was born in Ridgefield{ XE "USA, Connecticut, Fairfield, Ridgefield:(41.2815° N, 73.4982° W):Sears, Phebe (1796–1864)" \f "Place" } in 1796.^[9] She died in 1864 at the age of 68.^[9] Phebe was buried in Huron, Wayne County, New York{ XE "USA, New York, Wayne County, Huron:(43.2333° N, 76.8803° W):Sears, Phebe (1796–1864)" \f "Place" }.^[9]

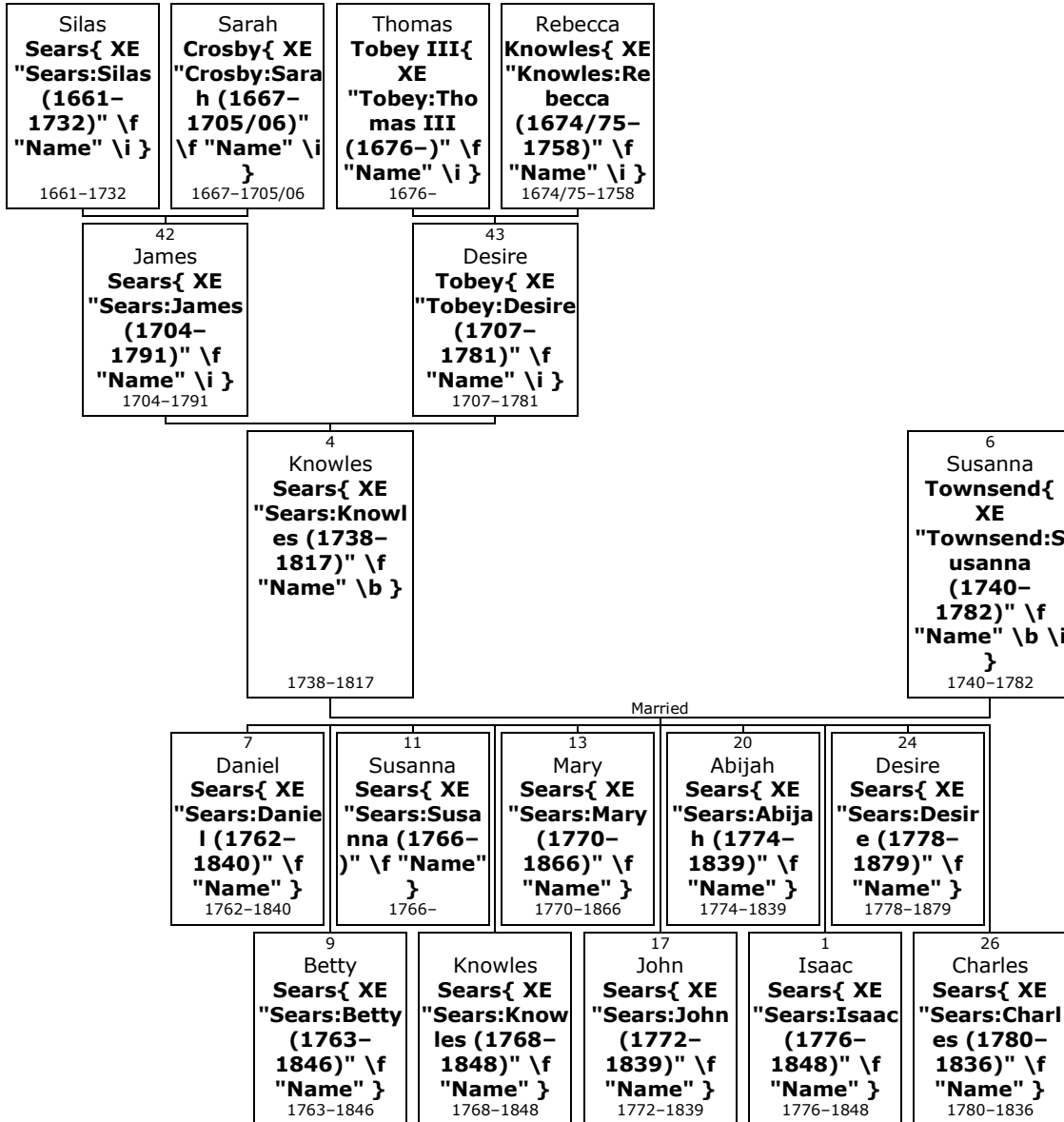
Family of Knowles Sears and Susanna Townsend{ TC "Knowles Sears and Susanna Townsend" \I 4 \f C}

Here are the details about **Knowles Sears**{ XE "Sears:Knowles (1738-1817)" \f "Name" \b } second marriage, with Susanna Townsend. You can read more about Knowles on page 17.

6. Capt Knowles Sears married **Susanna Townsend**{ XE "Townsend:Susanna (1740-1782)" \f "Name" \b \i }.^[10] They had ten children: Daniel (1762-1840), Betty (1763-1846), Susanna (1766-), Knowles (1768-1848), Mary (1770-1866), John (1772-1839), Abijah (1774-1839), Isaac (1776-1848), Desire (1778-1879) and Charles (1780-1836).

Susanna was born in Ridgefield{ XE "USA, Connecticut, Fairfield, Ridgefield:(41.2815° N, 73.4982° W):Townsend, Susanna (1740-1782)" \f "Place" } in 1740.^[10] She reached 42 years of age and died on 24th April 1782.^[10]

!Smallpox

Children of Knowles Sears and Susanna Townsend:

- + 7 m I. **Daniel**⁴ **Sears**{ XE "Sears:Daniel (1762-1840)" \f "Name" } was born in Ridgefield{ XE "USA, Connecticut, Fairfield, Ridgefield:(41.2815° N, 73.4982° W):Sears, Daniel (1762-1840)" \f "Place" } on 14th May 1762.^[9] He died in Van Buren, Onondaga, New York,{ XE "USA, New York, Onondaga, Van Buren:(43.1136° N, 76.3025° W):Sears, Daniel (1762-1840)" \f "Place" } on 18th February 1840, at the age of 77.^[9]

- + 9 f II. **Betty Sears**{ XE "Sears:Betty (1763–1846)" \f "Name" } was born in Ridgefield{ XE "USA, Connecticut, Fairfield, Ridgefield:(41.2815° N, 73.4982° W):Sears, Betty (1763–1846)" \f "Place" } on 31st October 1763.^[10] She died in Albany, New York,{ XE "USA, New York, Albany:(42.6029° N, 73.9717° W):Sears, Betty (1763–1846)" \f "Place" } on 28th July 1846, at the age of 82.^[10]
- + 11 f III. **Susanna Sears**{ XE "Sears:Susanna (1766–)" \f "Name" } was born in Ridgefield{ XE "USA, Connecticut, Fairfield, Ridgefield:(41.2815° N, 73.4982° W):Sears, Susanna (1766–)" \f "Place" } on 9th July 1766.
- m IV. **Knowles Sears**{ XE "Sears:Knowles (1768–1848)" \f "Name" \b } was born in Ridgefield{ XE "USA, Connecticut, Fairfield, Ridgefield:(41.2815° N, 73.4982° W):Sears, Knowles (1768–1848)" \f "Place" } on 29th July 1768.^[9] He died in Danbury{ XE "USA, Connecticut, Fairfield, Danbury:(41.3948° N, 73.454° W):Sears, Knowles (1768–1848)" \f "Place" } on 24th October 1848, at the age of 80.^[9] Knowles was buried in Danbury{ XE "USA, Connecticut, Fairfield, Danbury:(41.3948° N, 73.454° W):Sears, Knowles (1768–1848)" \f "Place" }.^[9]
- + 13 f V. **Mary Sears**{ XE "Sears:Mary (1770–1866)" \f "Name" } was born in Ridgefield{ XE "USA, Connecticut, Fairfield, Ridgefield:(41.2815° N, 73.4982° W):Sears, Mary (1770–1866)" \f "Place" } on 7th August 1770. She died on 16th December 1866, at the age of 96.
- + 17 m VI. **John Sears**{ XE "Sears:John (1772–1839)" \f "Name" } was born in Ridgefield{ XE "USA, Connecticut, Fairfield, Ridgefield:(41.2815° N, 73.4982° W):Sears, John (1772–1839)" \f "Place" } on 15th October 1772.^[9] He died in Camillus, Onondaga, New York,{ XE "USA, New York, Onondaga, Camillus:(43.0392° N, 76.3041° W):Sears, John (1772–1839)" \f "Place" } on 1st September 1839, at the age of 66.^[9]
- + 20 m VII. **Abijah Sears**{ XE "Sears:Abijah (1774–1839)" \f "Name" } was born in Danbury{ XE "USA, Connecticut, Fairfield, Danbury:(41.3948° N, 73.454° W):Sears, Abijah (1774–1839)" \f "Place" } on 8th August 1774. He died on 1st September 1839, at the age of 65.^[19]
- + 1 m VIII. **Isaac Sears**{ XE "Sears:Isaac (1776–1848)" \f "Name" } was born in Danbury{ XE "USA, Connecticut, Fairfield, Danbury:(41.3948° N, 73.454° W):Sears, Isaac (1776–1848)" \f "Place" } on 7th August 1776.^[20] He died on 20th September 1848, at the age of 72.
- + 24 f IX. **Desire Sears**{ XE "Sears:Desire (1778–1879)" \f "Name" } was born in Ridgefield{ XE "USA, Connecticut, Fairfield, Ridgefield:(41.2815° N, 73.4982° W):Sears, Desire (1778–1879)" \f "Place" } on 25th May 1778. She died in Danbury{ XE "USA, Connecticut, Fairfield, Danbury:(41.3948° N, 73.454° W):Sears, Desire (1778–1879)" \f "Place" } on 17th February 1879, at the age of 100.
- + 26 m X. **Charles Sears**{ XE "Sears:Charles (1780–1836)" \f "Name" } was born in Danbury{ XE "USA, Connecticut, Fairfield, Danbury:(41.3948° N, 73.454° W):Sears, Charles (1780–1836)" \f "Place" } on 3rd August 1780.^[9, 12] He died in Ridgefield{ XE "USA, Connecticut, Fairfield, Ridgefield:(41.2815° N, 73.4982° W):Sears, Charles (1780–1836)" \f "Place" } on 22nd April 1836, at the age of 55.^[9, 12]

¹⁹ Ancestry.com, New York, Wills and Probate Records, 1659-1999 (Provo, UT, USA, Ancestry.com Operations, Inc., 2015), Ancestry.com, Probate Records, 1818-1911; Author: New York. Surrogate's Court (Chautauqua County); Probate Place: Chautauqua, New York.

²⁰ Edmund West, comp., Family Data Collection - Individual Records (Provo, UT, USA, Ancestry.com Operations Inc, 2000), Ancestry.com, Birth year: 1776; Birth city: Danbury; Birth state: CT.

Siblings{ TC "Siblings" \I 2 \f C}

Family of Daniel Sears and Catharine Warin{ TC "Daniel Sears and Catharine Warin" \I 3 \f C}

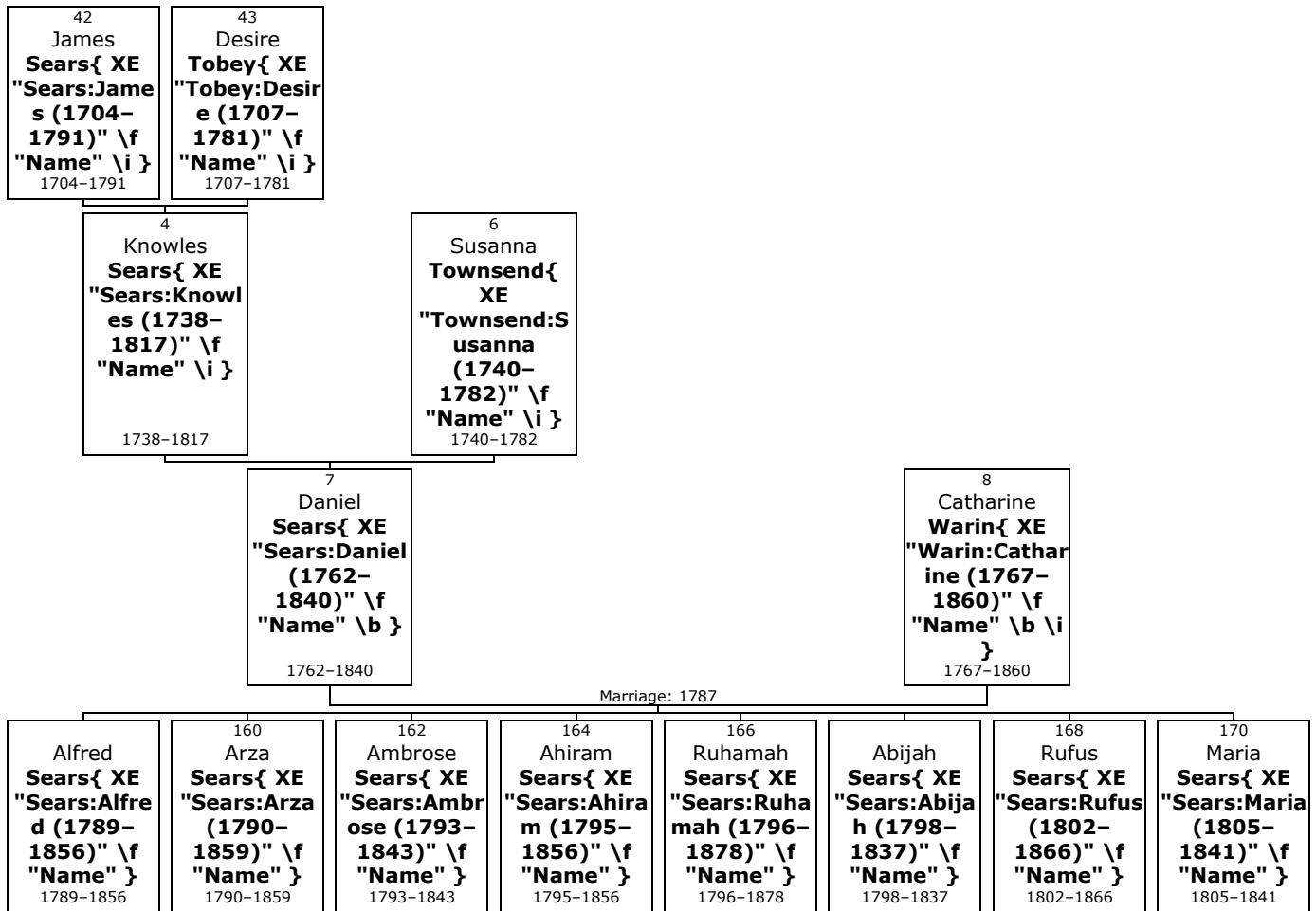

7. **Daniel⁴ Sears**{ XE "Sears:Daniel (1762-1840)" \f "Name" \b } (*Susanna³ Townsend*) was born on Friday, 14th May 1762, in Ridgefield, Fairfield, Connecticut, USA{ XE "USA, Connecticut, Fairfield, Ridgefield:(41.2815° N, 73.4982° W):Sears, Daniel (1762-1840)" \f "Place" }.^[21] He was the son of Knowles Sears{ XE "Sears:Knowles (1738-1817)" \f "Name" \i } (4) and Susanna Townsend{ XE "Townsend:Susanna (1740-1782)" \f "Name" \i } (6).

Daniel died in Van Buren, Onondaga, New York,{ XE "USA, New York, Onondaga, Van Buren:(43.1136° N, 76.3025° W):Sears, Daniel (1762-1840)" \f "Place" } on 18th February 1840, at the age of 77.^[21] He was buried in Baldwinsville{ XE "USA, New York, Onondaga, Baldwinsville:(43.1587° N, 76.3327° W):Sears, Daniel (1762-1840)" \f "Place" }.^[21]

!S.P. May p.276 Daniel Sears removed about 1793 to Rensselaerville, NY, and in 1835 to Van Buren, where he dwelt with his son Arza until his death in 1840.

!
!RESIDENCE: Index, 1790 Fed Census, Fairfield Co CT; 1790; Accelerated Indexing Systems; p 29; OKC Hist Soc; lists 1 adult male, 1 adult female, 1 male child in Ridgefieldtown, CT Birth: May 14, 1762 Ridgefield Fairfield County Connecticut, USA Death: Feb. 15, 1840

!
!Find A Grave Memorial# 52150726

Family links: Parents: Knowles Sears (1738 - 1817) Susanna Townsend Sears (1739 - 1782)
Spouse: Catharine Warin Sears (1767 - 1860) Children: Alfred Sears (1789 - 1856)* Arza Sears (1790 - 1859)* Ahiram Sears (1795 - 1856)* Abijah Sears (1798 - 1837)* *Calculated relationship

²¹ Ancestry.com, U.S., Find A Grave Index, 1600s-Current (Provo, UT, USA, Ancestry.com Operations, Inc., 2012), Ancestry.com.

Note: ae. 76-9-4 Burial: Sears Cemetery Baldwinsville Onondaga County New York, USA Edit Virtual Cemetery info [?] Created by: BArnold Record added: May 08, 2010

<https://www.wikitree.com/wiki/Sears-4760>

8. At the age of 24, Daniel married **Catharine Warin**{ XE "Warin:Catharine (1767–1860)" \f "Name" \b \i } on Friday, 30th March 1787, when she was 19 years old. They had eight children: Alfred (1789–1856), Arza (1790–1859), Ambrose (1793–1843), Ahiram (1795–1856), Ruhamah (1796–1878), Abijah (1798–1837), Rufus (1802–1866) and Maria (1805–1841).

Catharine was born in perh, Rensselaerville, Albany,{ XE "USA, New York, Albany, Rensselaerville, perh: :Warin, Catharine (1767–1860)" \f "Place" } on Saturday, 10th October 1767. She reached 92 years of age and died on 3rd April 1860.

DAR records say Waring Birth: Oct. 3, 1767 Death: Apr. 3, 1860 Family links: Spouse: Daniel Sears (1762 - 1840)* Children: Alfred Sears (1789 - 1856)* Arza Sears (1790 - 1859)* Ahiram Sears (1795 - 1856)* Abijah Sears (1798 - 1837)* *Calculated relationship Note: ae. 92y 6m, w/o Daniel Burial: Sears Cemetery Baldwinsville Onondaga County New York, USA Edit Virtual Cemetery info [?] Created by: BArnold Record added: May 08, 2010 Find A Grave Memorial# 52150725

Children of Daniel Sears and Catharine Warin:

- | | | | |
|-------|---|--|---|
| | m | I. Alfred⁵ Sears { XE "Sears:Alfred (1789–1856)" \f "Name" \b } was born in perh{ XE "USA, New York, Albany, Rensselaerville, perh: :Sears, Alfred (1789–1856)" \f "Place" } on 14 th January 1789. He died on 28 th July 1856, at the age of 67. Alfred was buried in Myrtle Grove Cemetery, Lysander, Onondaga{ XE "USA, New York, Onondaga, Lysander, Myrtle Grove Cemetery: :Sears, Alfred (1789–1856)" \f "Place" }. | |
| + 160 | m | II. Arza Sears { XE "Sears:Arza (1790–1859)" \f "Name" } was born in Rensselaerville{ XE "USA, New York, Albany, Rensselaerville:(42.5161° N, 74.1383° W):Sears, Arza (1790–1859)" \f "Place" } on 17 th October 1790. ^[21, 22] He died in Baldwinsville, Onondaga,{ XE "USA, New York, Onondaga, Baldwinsville:(43.1587° N, 76.3327° W):Sears, Arza (1790–1859)" \f "Place" } on 15 th July 1859, at the age of 68. ^[21] | |
| + 162 | m | III. Ambrose Sears { XE "Sears:Ambrose (1793–1843)" \f "Name" } was born in perh, Rensselaerville,{ XE "USA, New York, Albany, Rensselaerville, perh: :Sears, Ambrose (1793–1843)" \f "Place" } on 17 th August 1793. He died in Ellington, Chautauqua,{ XE "USA, New York, Chautauqua, Ellington:(42.2167° N, 79.1081° W):Sears, Ambrose (1793–1843)" \f "Place" } on 9 th August 1843, at the age of 49. | |
| + 164 | m | IV. Ahiram Sears { XE "Sears:Ahiram (1795–1856)" \f "Name" } was born in perh{ XE "USA, New York, Albany, Rensselaerville, perh: :Sears, Ahiram (1795–1856)" \f "Place" } on 5 th April 1795. ^[21, 23] He died in Baldwinsville, Onondaga,{ XE "USA, New York, Onondaga, Baldwinsville:(43.1587° N, 76.3327° W):Sears, Ahiram (1795–1856)" \f "Place" } on 9 th April 1856, at the age of 61. ^[21] | |
| + 166 | f | V. Ruhamah Sears { XE "Sears:Ruhamah (1796–1878)" \f "Name" } was born in perh{ XE "USA, New York, Albany, Rensselaerville, perh: :Sears, Ruhamah (1796–1878)" \f "Place" } on 22 nd December 1796. ^[24, 25] She died in Candor, Tioga,{ XE "USA, New York, Tioga, Candor:(42.2329° N, 76.3425° W):Sears, Ruhamah (1796–1878)" \f "Place" } on 4 th April 1878, at the age of 81. ^[25] | |
| | m | VI. Abijah Sears { XE "Sears:Abijah (1798–1837)" \f "Name" \b } was born in perh{ XE "USA, New York, Albany, Rensselaerville, perh: :Sears, Abijah (1798–1837)" \f "Place" } on 25 th November 1798. He died on 26 th June 1837, at the age of 38. Abijah was buried in Sears Cemetery, Baldwinsville, Onondaga{ XE "USA, New York, Onondaga, Baldwinsville, Sears Cemetery: :Sears, Abijah (1798–1837)" \f "Place" }. |  |

Abijah

²² Ancestry.com, New York, State Census, 1855 (Provo, UT, USA, Ancestry.com Operations, Inc., 2013), Ancestry.com.

²³ Ancestry.com, New York, State Census, 1855 (Provo, UT, USA, Ancestry.com Operations, Inc., 2013), Ancestry.com, Record for Marcus Sears. <http://search.ancestry.com/cgi-bin/sse.dll?db=7181&h=1655401430&indiv=try>.

²⁴ Ancestry.com, New York, State Census, 1865 (Provo, UT, USA, Ancestry.com Operations, Inc., 2014), Ancestry.com, Record for Charles F Barager. <http://search.ancestry.com/cgi-bin/sse.dll?db=7218&h=1284516&indiv=try>.

²⁵ Ancestry.com, U.S., Find A Grave Index, 1600s-Current (Provo, UT, USA, Ancestry.com Operations, Inc., 2012), Ancestry.com, Record for Capt Charles Fredrick Sr Barager. <http://search.ancestry.com/cgi-bin/sse.dll?db=60525&h=81239694&indiv=try>.

- + 168 m VII. **Rufus Sears**{ XE "Sears:Rufus (1802–1866)" \f "Name" } was born in perh{ XE "USA, New York, Albany, Rensselaerville, perh: :Sears, Rufus (1802–1866)" \f "Place" } on 2nd September 1802. He died on 26th November 1866, at the age of 64.
- + 170 f VIII. **Maria Sears**{ XE "Sears:Maria (1805–1841)" \f "Name" } was born in perh{ XE "USA, New York, Albany, Rensselaerville, perh: :Sears, Maria (1805–1841)" \f "Place" } on 1st March 1805. She died in Le Roy, Calhoun, Michigan,{ XE "USA, Michigan, Calhoun, Le Roy:(44.0382° N, 85.4526° W):Sears, Maria (1805–1841)" \f "Place" } on 19th October 1841, at the age of 36.

Family of Betty Sears and Nathan Hawley{ TC "Betty Sears and Nathan Hawley" \I 3 \f C}

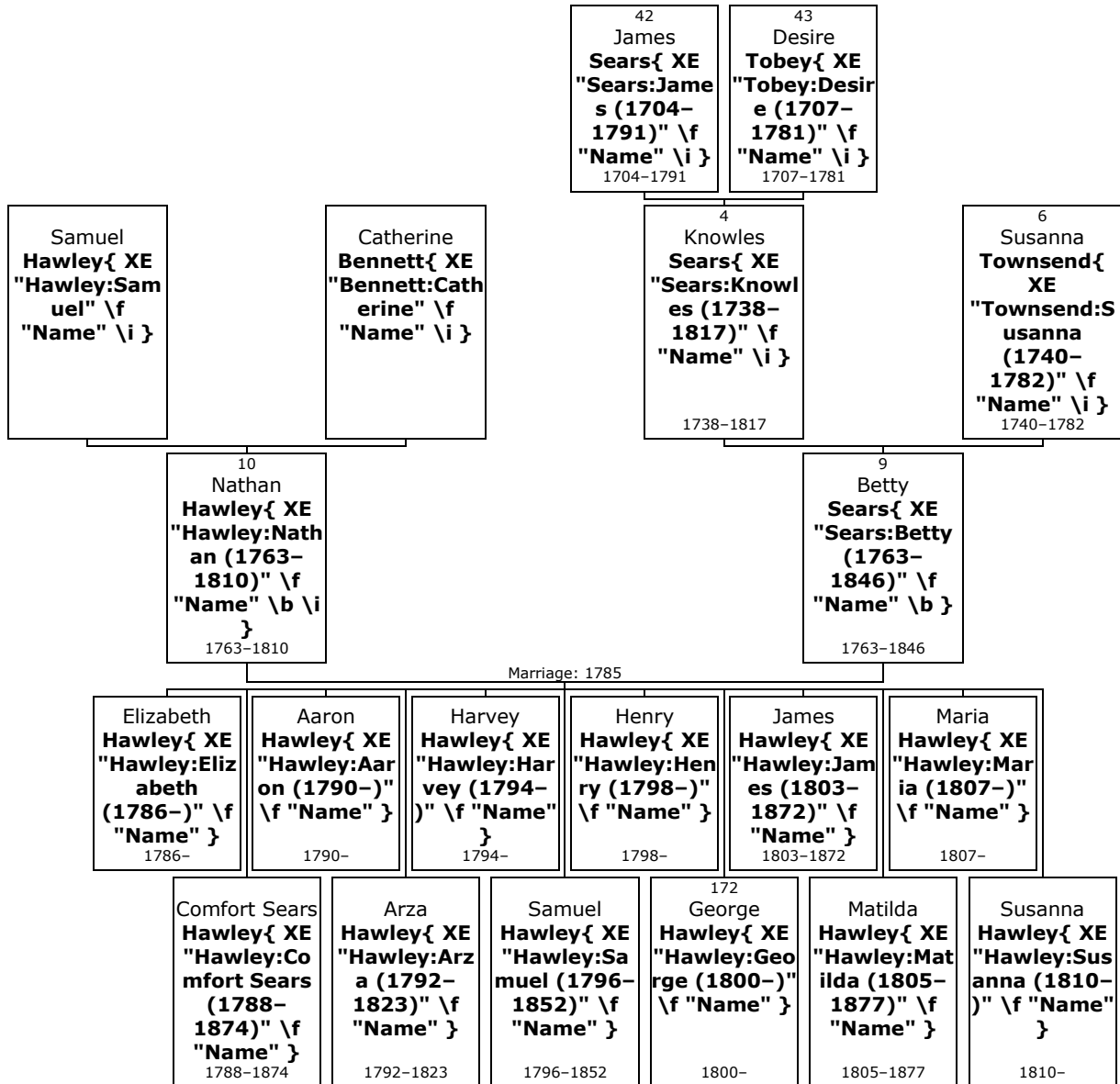

- 9. **Betty⁴ Sears**{ XE "Sears:Betty (1763–1846)" \f "Name" \b } (*Susanna³ Townsend*) was born on Monday, 31st October 1763, in Ridgefield, Fairfield, Connecticut, USA{ XE "USA, Connecticut, Fairfield, Ridgefield:(41.2815° N, 73.4982° W):Sears, Betty (1763–1846)" \f "Place" }.^[26] She was the daughter of Knowles Sears{ XE "Sears:Knowles (1738–1817)" \f "Name" \i } (4) and Susanna Townsend{ XE "Townsend:Susanna (1740–1782)" \f "Name" \i } (6).

²⁶ Ancestry.com, U.S., Sons of the American Revolution Membership Applications, 1889-1970 (Provo, UT, USA, Ancestry.com Operations, Inc., 2011), Ancestry.com. [Source citation includes one media item]

Betty died in Albany, New York, { XE "USA, New York, Albany:(42.6029° N, 73.9717° W):Sears, Betty (1763–1846)" \f "Place" } on 28th July 1846, at the age of 82.^[26]

!S.P. May p.177 Calls her Betty - She died at the house of her son Aaron. Could be a problem since Knowles has another daughter Elizabeth with Charity Haviland which dau. m. Nathaniel Brush? Suspicious that this daughter would also have the name Elizabeth and a middle name (middle names were not common until 1800)

!

<https://www.wikitree.com/wiki/Sears-4766>

!Ridgefield, CT (2nd Church) Marriage Records 1769 to 1800 From Early Connecticut Marriages Prior to 1800 By Frederick W. Bailey The town of Ridgefield was incorporated October, 1709. The township was purchased of the Indians by a company of twenty-nine individuals from Norwalk and Milford, 1707-8. The First Congregational Church was organized in 1712 and is located at Ridgefield Center. The Second Congregational Church is at Ridgebury and was organized January 18, 1769. The following are the marriages from the Second Church records. Rev. Samuel Camp pastor from 1769 to 1804.

From: CBOT [SMTP:cbotsales@ottawa.cbc.ca] Sent: Monday, October 26, 1998 4:17 PM To: ray.sears@halliburton.com

!Subject: John Sears descendant Hello ray. I viewed your site by way of the Onondaga County, New York website, and appreciate the info. I also am a direct descendant of Richard Sears. My great grandfather was Jacob Sears Ladu, who's grandmother was Tamma Sears, daughter of John Sears (born 1772), son of Knowles Sears, etc. etc. I recently discovered that John Sears sister, Elizabeth Comfort Sears (Betty) was married to a Nathan Hawley and lived in Albany, New York. There was a painting made of her and her husband and eight of their children (I think they had 10 or twelve). The eighth child was in her lap. This painting is hanging in an Art Gallery in Albany, New York and was painted by a man named Wilkie. I will enjoy reading the rest of your information at your site. When was the painting of Richard supposed to have been made?

Robin Warner Saunders Ottawa, Ontario, Canada "cbotsales@ottawa.cbc.ca"

10. At the age of 21, Betty married **Nathan Hawley**{ XE "Hawley:Nathan (1763–1810)" \f "Name" \b \i } on Thursday, 14th April 1785, in Ridgefield, Fairfield, Connecticut,{ XE "USA, Connecticut, Fairfield, Ridgefield:(41.2815° N, 73.4982° W):Sears, Betty (1763–1846)" \f "Place" } when he was 21 years old. They had twelve children: Elizabeth (1786–), Comfort (1788–1874), Aaron (1790–), Arza (1792–1823), Harvey (1794–), Samuel (1796–1852), Henry (1798–), George (1800–), James (1803–1872), Matilda (1805–1877), Maria (1807–) and Susanna (1810–).

Nathan was born in perh, Ridgefield,{ XE "USA, Connecticut, Fairfield, Ridgefield, perh: :Hawley, Nathan (1763–1810)" \f "Place" } on Friday, 9th September 1763. He was the son of Samuel Hawley{ XE "Hawley:Samuel" \f "Name" \i } and Catherine Bennett{ XE "Bennett:Catherine" \f "Name" \i }.

Nathan reached 46 years of age and died on 27th February 1810.

<https://www.ancestry.com/family-tree/person/tree/30794454/person/13770023079/facts>

Nathan Hawley family

catremblay originally shared this on 24 jul 2012

Linked To

Nathan Hawley Elizabeth Comfort Sears Comfort Sears Hawley Elizabeth "Betsey" Hawley Aaron Hawley Irza Hawley Harvey Hawley Samuel Hawley Henry Hawley

Saved by

dwp642000

AlfredCochran

plater1381

diane23159

Victoria5r

stephen austin

John Howell

Madeline Ramsey

Michael Sharp

la4883

Comments

plater1381 Identification of people in the painting: Elizabeth (Sears) Hawley holding George Hawley (born 1800) by date on Painting (1801) ~1 year old. Nathan Hawley sitting at table. Elizabeth (Sears) Grant

Eldest daughter. Then Comfort, Aaron, Irza, Harvey, Samuel and Henry (by order of height). James, Matilda, Mary and Susan were not born yet.

Children of Betty Sears and Nathan Hawley:

- f I. **Elizabeth⁵ Hawley**{ XE "Hawley:Elizabeth (1786-)" \f "Name" \b } was born in perh, Ridgefield,{ XE "USA, Connecticut, Fairfield, Ridgefield, perh: :Hawley, Elizabeth (1786-)" \f "Place" } on 20th July 1786.
- f II. **Comfort Sears Hawley**{ XE "Hawley:Comfort Sears (1788-1874)" \f "Name" \b } was born in perh{ XE "USA, Connecticut, Fairfield, Ridgefield, perh: :Hawley, Comfort Sears (1788-1874)" \f "Place" } on 27th January 1788. She died in 1874 at the age of 85.
- m III. **Aaron Hawley**{ XE "Hawley:Aaron (1790-)" \f "Name" \b } was born in perh{ XE "USA, Connecticut, Fairfield, Ridgefield, perh: :Hawley, Aaron (1790-)" \f "Place" } on 25th January 1790.
- IV. **Arza Hawley**{ XE "Hawley:Arza (1792-1823)" \f "Name" \b } was born in perh{ XE "USA, Connecticut, Fairfield, Ridgefield, perh: :Hawley, Arza (1792-1823)" \f "Place" } on 14th March 1792. He or she died on 16th September 1823, at the age of 31.
- m V. **Harvey Hawley**{ XE "Hawley:Harvey (1794-)" \f "Name" \b } was born in perh{ XE "USA, Connecticut, Fairfield, Ridgefield, perh: :Hawley, Harvey (1794-)" \f "Place" } on 20th February 1794.
- m VI. **Samuel Hawley**{ XE "Hawley:Samuel (1796-1852)" \f "Name" \b } was born in perh{ XE "USA, Connecticut, Fairfield, Ridgefield, perh: :Hawley, Samuel (1796-1852)" \f "Place" } on 22nd March 1796. He died on 11th April 1852, at the age of 56.
- m VII. **Henry Hawley**{ XE "Hawley:Henry (1798-)" \f "Name" \b } was born in perh{ XE "USA, Connecticut, Fairfield, Ridgefield, perh: :Hawley, Henry (1798-)" \f "Place" } in 1798.
- + 172 m VIII. **George Hawley**{ XE "Hawley:George (1800-)" \f "Name" } was born in perh{ XE "USA, Connecticut, Fairfield, Ridgefield, perh: :Hawley, George (1800-)" \f "Place" } on 12th July 1800.
- m IX. **James Hawley**{ XE "Hawley:James (1803-1872)" \f "Name" \b } was born in perh{ XE "USA, Connecticut, Fairfield, Ridgefield, perh: :Hawley, James (1803-1872)" \f "Place" } on 4th June 1803. He died on 31st October 1872, at the age of 69.
- f X. **Matilda Hawley**{ XE "Hawley:Matilda (1805-1877)" \f "Name" \b } was born in perh{ XE "USA, Connecticut, Fairfield, Ridgefield, perh: :Hawley, Matilda (1805-1877)" \f "Place" } on 26th March 1805. She died on 2nd January 1877, at the age of 71.
- f XI. **Maria Hawley**{ XE "Hawley:Maria (1807-)" \f "Name" \b } was born in perh{ XE "USA, Connecticut, Fairfield, Ridgefield, perh: :Hawley, Maria (1807-)" \f "Place" } on 26th December 1807.
- f XII. **Susanna Hawley**{ XE "Hawley:Susanna (1810-)" \f "Name" \b } was born in perh{ XE "USA, Connecticut, Fairfield, Ridgefield, perh: :Hawley, Susanna (1810-)" \f "Place" } on 13th March 1810.

Family of Susanna Sears and Heman Sears{ TC "Susanna Sears and Heman Sears" \I 3 \f C}

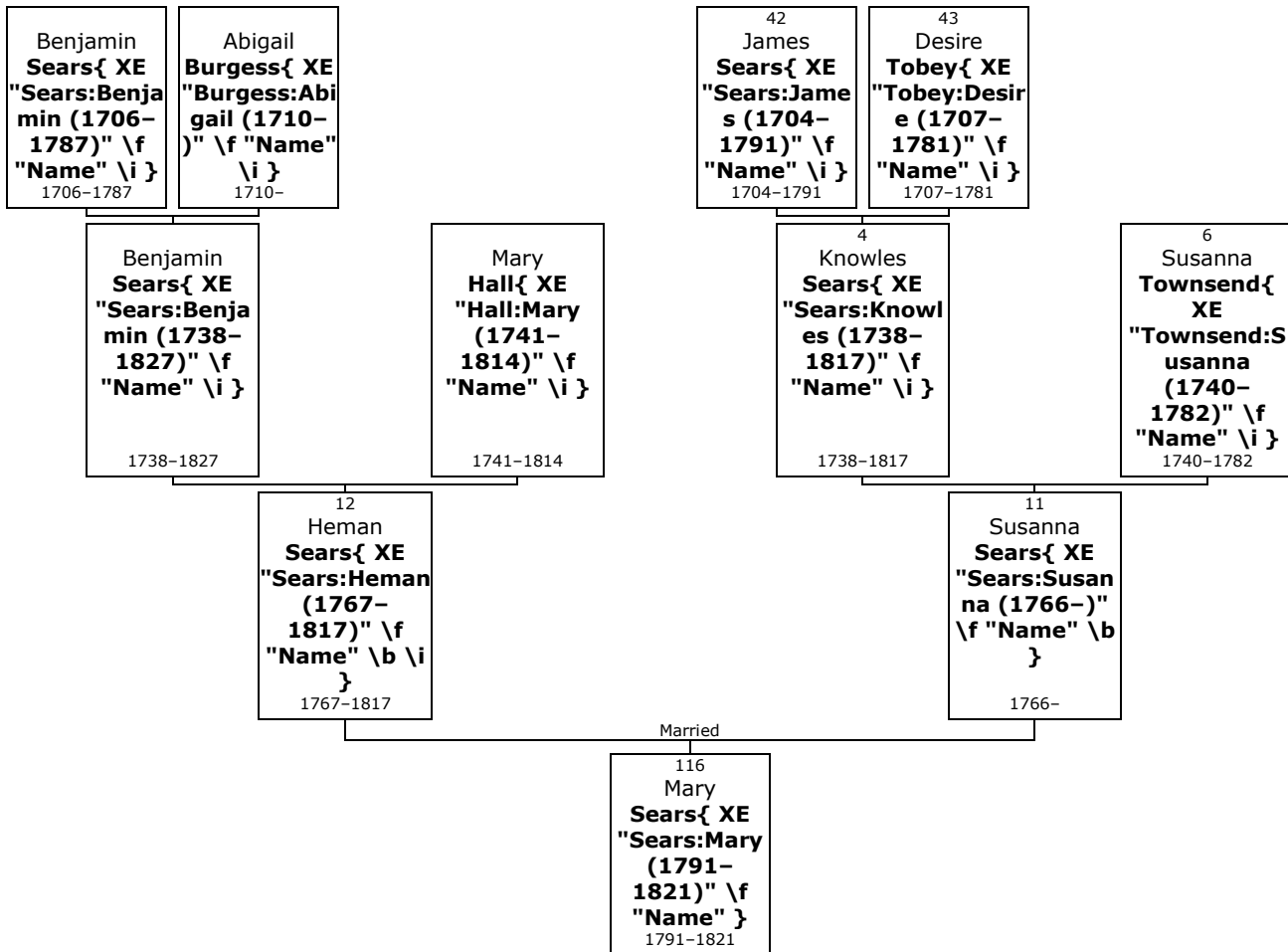

11. **Susanna⁴ Sears**{ XE "Sears:Susanna (1766-)" \f "Name" \b } (*Susanna³ Townsend*) was born on Wednesday, 9th July 1766, in Ridgefield, Fairfield, Connecticut, USA{ XE "USA, Connecticut, Fairfield, Ridgefield:(41.2815° N, 73.4982° W):Sears, Susanna (1766-)" \f "Place" }. She was the daughter of Knowles Sears{ XE "Sears:Knowles (1738-1817)" \f "Name" \i } (4) and Susanna Townsend{ XE "Townsend:Susanna (1740-1782)" \f "Name" \i } (6).

!S P May p.207 Susie Sears lived with her daughter, and removed with the family to IL, where their house was destroyed by a cyclone, and she lost her life.

<https://www.wikitree.com/wiki/Sears-4761>

12. She married **Heman Sears**{ XE "Sears:Heman (1767-1817)" \f "Name" \b \i }. They had one daughter: Mary (1791-1821).

Heman was born in Southeast, Putnam, New York,{ XE "USA, New York, Putnam, Southeast:(41.4054° N, 73.6001° W):Sears, Heman (1767-1817)" \f "Place" } on Wednesday, 7th January 1767. He was the son of Benjamin Sears{ XE "Sears:Benjamin (1738-1827)" \f "Name" \i } and Mary Hall{ XE "Hall:Mary (1741-1814)" \f "Name" \i }.

Heman reached 50 years of age and died on 18th August 1817. He was buried at gr-st in Milltown, Dutchess{ XE "USA, New York, Dutchess, Milltown: :Sears, Heman (1767-1817)" \f "Place" }.

S P May No 438 p. 207

Daughter of Susanna Sears and Heman Sears:

+ 116 f I. **Mary⁵ Sears**{ XE "Sears:Mary (1791-1821)" \f "Name" } was born in Southeast{ XE "USA, New York, Dutchess, Southeast: :Sears, Mary (1791-1821)" \f "Place" } in 1791.^[27] She died on 11th April 1821, at the age of 30.^[27]

Mary Sears{ TC "Mary Sears" \I 3 \f C}

13. Mary⁴ Sears{ XE "Sears:Mary (1770-1866)" \f "Name" \b } (*Susanna³ Townsend*) was born on Tuesday, 7th August 1770, in Ridgefield, Fairfield, Connecticut, USA{ XE "USA, Connecticut, Fairfield, Ridgefield:(41.2815° N, 73.4982° W):Sears, Mary (1770-1866)" \f "Place" }. She was the daughter of Knowles Sears{ XE "Sears:Knowles (1738-1817)" \f "Name" \i } (4) and Susanna Townsend{ XE "Townsend:Susanna (1740-1782)" \f "Name" \i } (6).

Mary died on 16th December 1866, at the age of 96.

SPM gr-st They lived in the Boggs District, Danbury, CT

<https://www.wikitree.com/wiki/Sears-4763>

Ridgefield, CT (2nd Church) Marriage Records 1769 to 1800 From Early Connecticut Marriages Prior to 1800 By Frederick W. Bailey The town of Ridgefield was incorporated October, 1709. The township was purchased of the Indians by a company of twenty-nine individuals from Norwalk and Milford, 1707-8. The First Congregational Church was organized in 1712 and is located at Ridgefield Center. The Second Congregational Church is at Ridgebury and was organized January 18, 1769. The following are the marriages from the Second Church records. Rev. Samuel Camp pastor from 1769 to 1804.

Marriages with Elijah Benedict, Isaac Townsend (Page 31) and Forward Stevens (Page 32) are known.

²⁷ "Ancestry Family Tree", Record for George Sears-<https://www.ancestry.com/family-tree/tree/112169379/person/232092345437>.
<https://search.ancestry.com/cgi-bin/sse.dll?db=1030&h=232092345437&indiv=try>.

Family of Mary Sears and Elijah Benedict{ TC "Mary Sears and Elijah Benedict" \I 4 \f C}

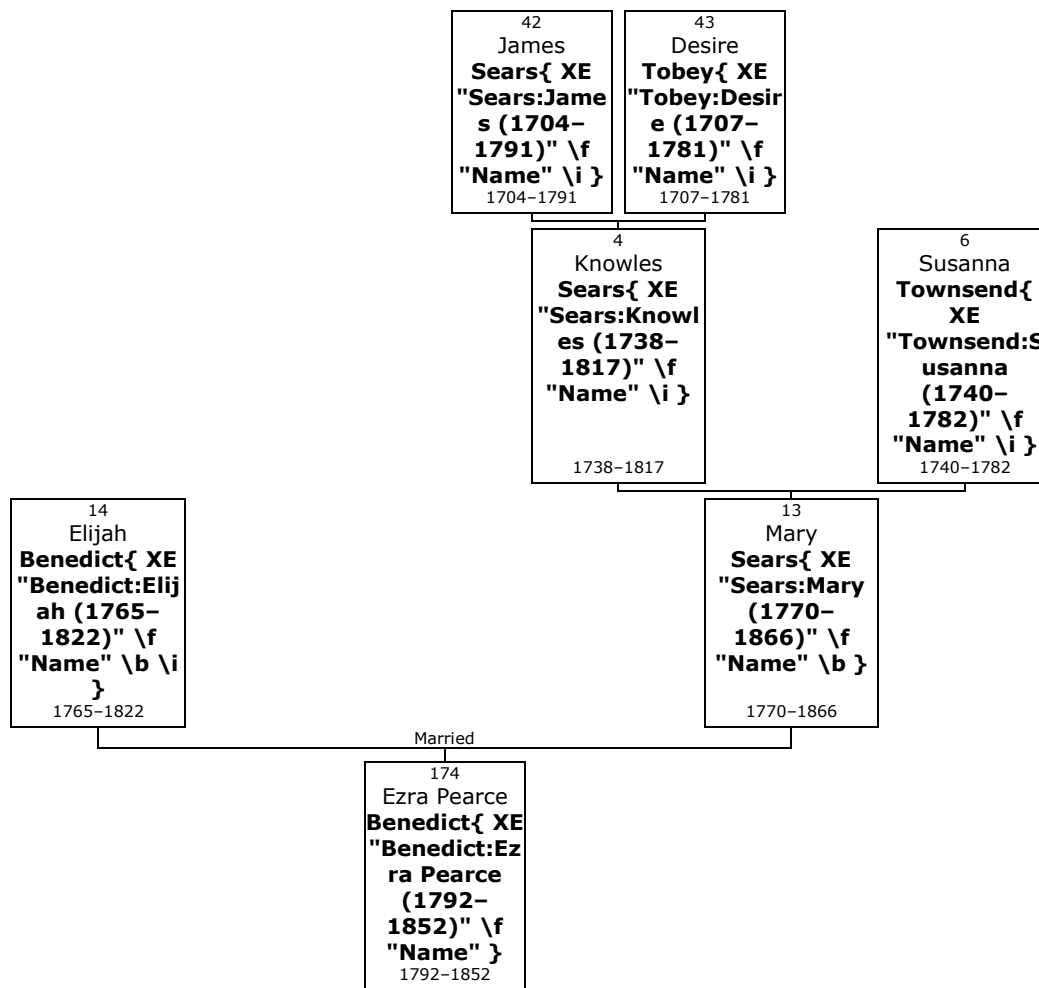

Here are the details about **Mary Sears**{ XE "Sears:Mary (1770-1866)" \f "Name" \b } first marriage, with Elijah Benedict. You can read more about Mary on page 29.

- 14.** Mary Sears married **Elijah Benedict**{ XE "Benedict:Elijah (1765-1822)" \f "Name" \b \i }. They had one son: Ezra (1792-1852).

Elijah was born on Friday, 15th November 1765. He reached 57 years of age and died on 23rd November 1822.

Son of Mary Sears and Elijah Benedict:

- + 174 m I. **Ezra Pearce⁵ Benedict**{ XE "Benedict:Ezra Pearce (1792-1852)" \f "Name" \b } was born in Danbury{ XE "USA, Connecticut, Fairfield, Danbury:(41.3948° N, 73.454° W):Benedict, Ezra Pearce (1792-1852)" \f "Place" \b } on 31st August 1792. He died in Danbury{ XE "USA, Connecticut, Fairfield, Danbury:(41.3948° N, 73.454° W):Benedict, Ezra Pearce (1792-1852)" \f "Place" \b } on 19th January 1852, at the age of 59.

Family of Mary Sears and Isaac Townsend{ TC "Mary Sears and Isaac Townsend" \I 4 \f C}

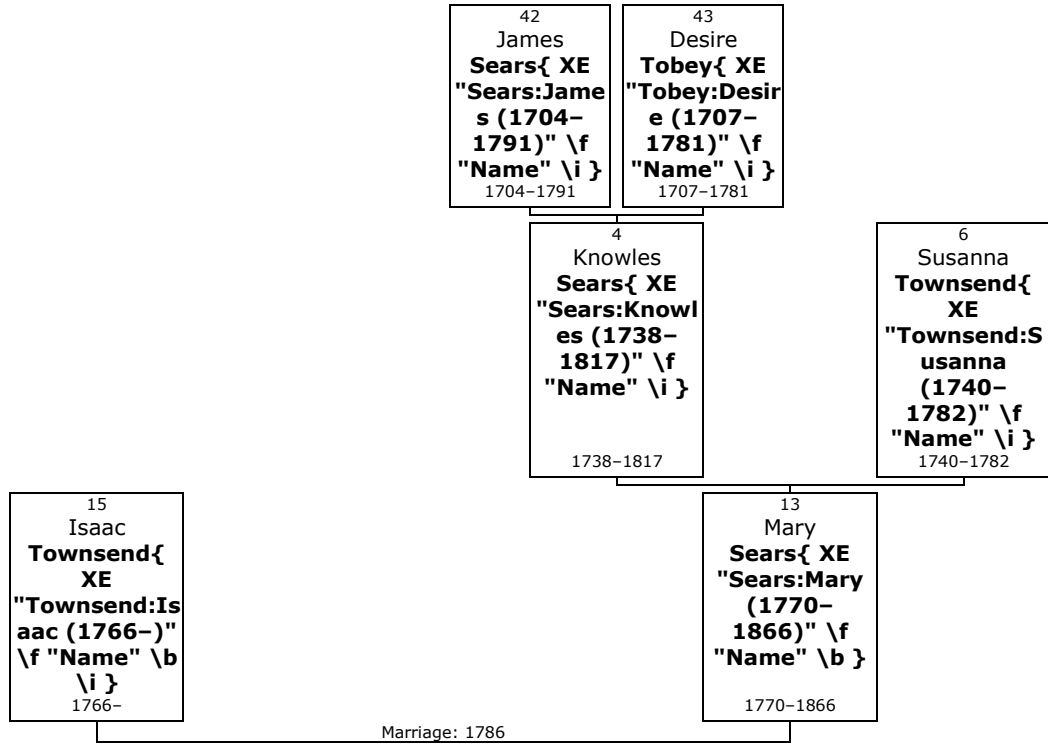

Here are the details about **Mary Sears**{ XE "Sears:Mary (1770-1866)" \f "Name" \b } second marriage, with Isaac Townsend. You can read more about Mary on page 29.

- 15. Mary Sears married **Isaac Townsend**{ XE "Townsend:Isaac (1766-)" \f "Name" \b \i } on Thursday, 23rd November 1786, in Ridgefield{ XE "USA, Connecticut, Fairfield, Ridgefield:(41.2815° N, 73.4982° W):Sears, Mary (1770-1866)" \f "Place" }. They had no known children.

Isaac was born in 1766. Fredericksburg, NY.

Family of Mary Sears and Forward Stevens{ TC "Mary Sears and Forward Stevens" \I 4 \f C}

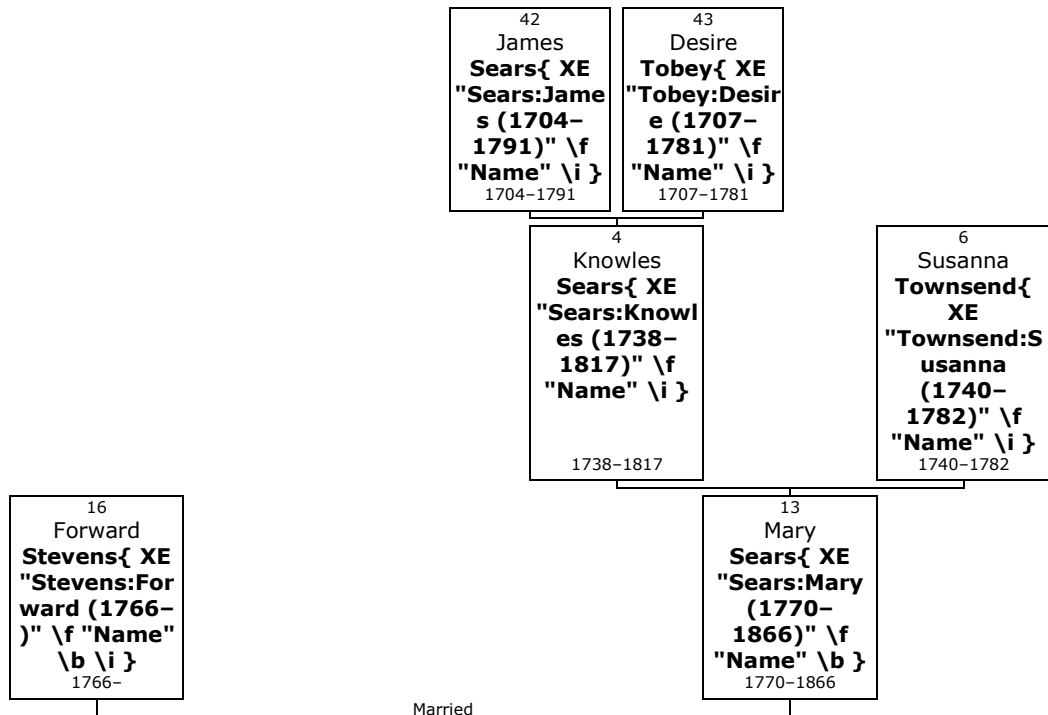

Here are the details about **Mary Sears**{ XE "Sears:Mary (1770–1866)" \f "Name" \b } third marriage, with Forward Stevens. You can read more about Mary on page 29.

- 16.** Mary Sears married **Forward Stevens**{ XE "Stevens:Forward (1766–)" \f "Name" \b \i }. They had no known children.

Forward was born in 1766.

John Sears{ TC "John Sears" \I 3 \f C}

- 17.** **John**⁴ **Sears**{ XE "Sears:John (1772–1839)" \f "Name" \b } (*Susanna*³ *Townsend*) was born on Thursday, 15th October 1772, in Ridgefield, Fairfield, Connecticut, USA{ XE "USA, Connecticut, Fairfield, Ridgefield:(41.2815° N, 73.4982° W):Sears, John (1772–1839)" \f "Place" }.^[28] He was the son of Knowles Sears{ XE "Sears:Knowles (1738–1817)" \f "Name" \i } (4) and Susanna Townsend{ XE "Townsend:Susanna (1740–1782)" \f "Name" \i } (6).

John died in Camillus, Onondaga, New York,{ XE "USA, New York, Onondaga, Camillus:(43.0392° N, 76.3041° W):Sears, John (1772–1839)" \f "Place" } on 1st September 1839, at the age of 66.^[28] He was buried in Baldwinsville{ XE "USA, New York, Onondaga, Baldwinsville:(43.1587° N, 76.3327° W):Sears, John (1772–1839)" \f "Place" }.^[28]

!S.P. May p.277 John Sears removed to Camillus, NY, and after the death of his first wife, to Red Creek, Wolcott co., NY

<https://www.wikitree.com/wiki/Sears-4764>

!Find A Grave Memorial# 53910989

Birth: Oct. 15, 1772 Death: Sep. 1, 1839

Family links: Parents: Knowles Sears (1738 - 1817) Susanna Townsend Sears (1739 - 1782)

Spouse: Mary Townsend Sears (1772 - 1819)* Children: Tamma Sears Lamerson (1795 - 1864)*

Hannah Sears Kingsley (1797 - 1898)* Knowles Sears (1800 - 1820)* Betsy Sears (1802 - 1819)*

*Calculated relationship Burial: Riverview Cemetery Baldwinsville Onondaga County New York, USA Plot: 224 RV Maintained by: BArnold Originally Created by: Mojo Warren Record added: Jun 20, 2010

Marriages with Mary Townsend and Phebe Lusk (Page 35) are known.

²⁸ Ancestry.com, U.S., Find A Grave Index, 1600s-Current (Provo, UT, USA, Ancestry.com Operations, Inc., 2012), Ancestry.com.

Family of John Sears and Mary Townsend{ TC "John Sears and Mary Townsend" \I 4 \f C}

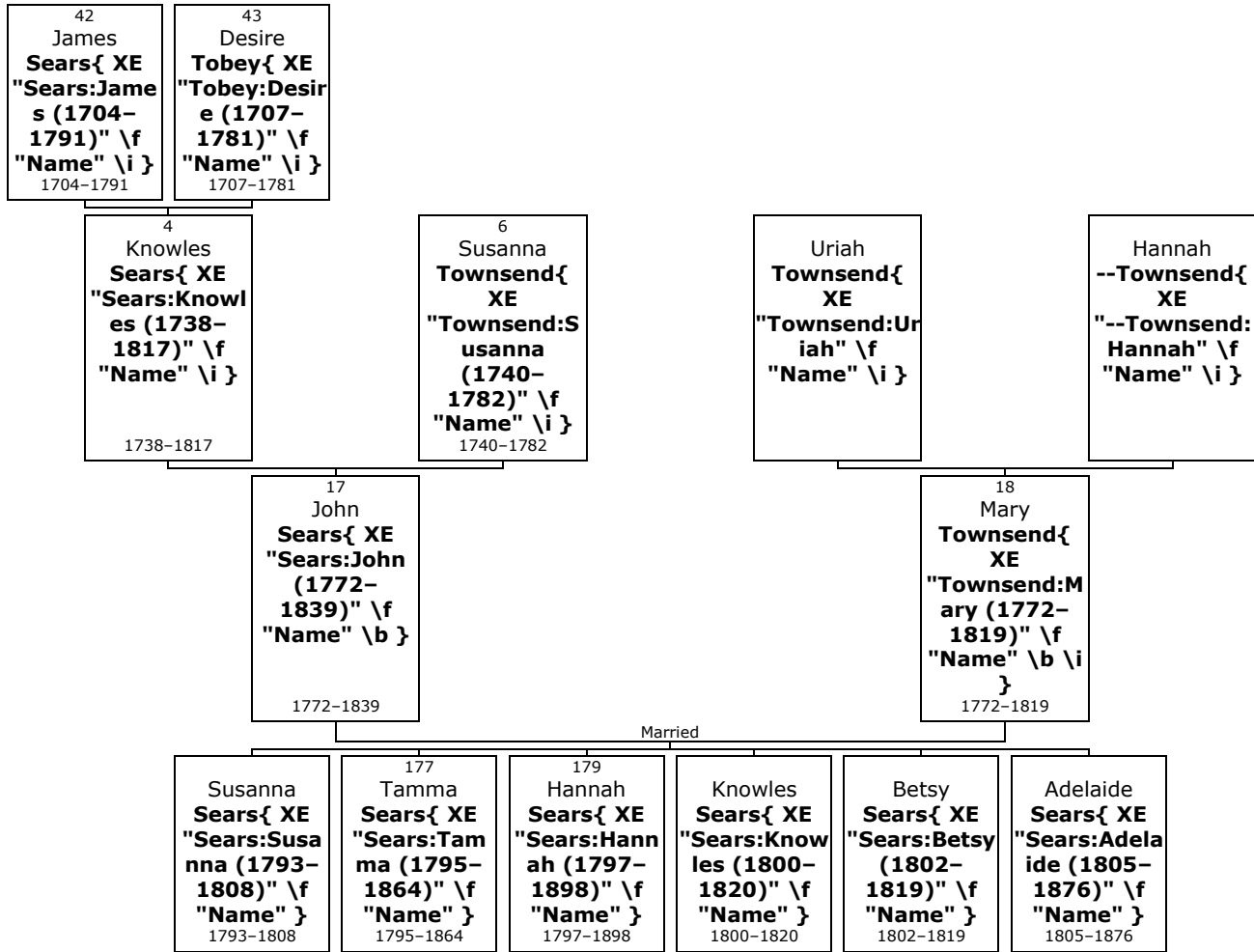

Here are the details about **John Sears**{ XE "Sears:John (1772-1839)" \f "Name" \b } first marriage, with Mary Townsend. You can read more about John on page 32.

18. John Sears married **Mary Townsend**{ XE "Townsend:Mary (1772-1819)" \f "Name" \b \i }. They had six children: Susanna (1793-1808), Tamma (1795-1864), Hannah (1797-1898), Knowles (1800-1820), Betsy (1802-1819) and Adelaide (1805-1876).

Mary was born in perh, Camillus, Onondaga, New York,{ XE "USA, New York, Onondaga, Camillus, perh: :Townsend, Mary (1772-1819)" \f "Place" } on Saturday, 25th July 1772. She was the daughter of Uriah Townsend{ XE "Townsend:Uriah" \f "Name" \i } and Hannah --Townsend{ XE "--Townsend:Hannah" \f "Name" \i }.

Mary reached 47 years of age and died on 6th August 1819.

<https://www.ancestry.com/family-tree/person/tree/114260774/person/102095132520/facts>
<https://www.wikitree.com/wiki/Townsend-7818>

Children of John Sears and Mary Townsend:

- f I. **Susanna**⁵ **Sears**{ XE "Sears:Susanna (1793-1808)" \f "Name" \b } was born in Camillus{ XE "USA, New York, Onondaga, Camillus:(43.0392° N, 76.3041° W):Sears, Susanna (1793-1808)" \f "Place" } on 30th November 1793. She died on 22nd August 1808, at the age of 14.
- + 177 f II. **Tamma Sears**{ XE "Sears:Tamma (1795-1864)" \f "Name" } was born in Camillus{ XE "USA, New York, Onondaga, Camillus:(43.0392° N, 76.3041° W):Sears, Tamma (1795-

1864)" \f "Place" } on 26th October 1795.^[29] She died on 24th September 1864, at the age of 68.^[29]

- + 179 f III. **Hannah Sears**{ XE "Sears:Hannah (1797–1898)" \f "Name" } was born in Camillus{ XE "USA, New York, Onondaga, Camillus:(43.0392° N, 76.3041° W):Sears, Hannah (1797–1898)" \f "Place" } on 12th December 1797.^[30] She died in Van Buren{ XE "USA, New York, Onondaga, Van Buren:(43.1136° N, 76.3025° W):Sears, Hannah (1797–1898)" \f "Place" } on 16th March 1898, at the age of 100.
- m IV. **Knowles Sears**{ XE "Sears:Knowles (1800–1820)" \f "Name" \b } was born in Camillus{ XE "USA, New York, Onondaga, Camillus:(43.0392° N, 76.3041° W):Sears, Knowles (1800–1820)" \f "Place" } on 18th May 1800. He died on 18th August 1820, at the age of 20.
- f V. **Betsy Sears**{ XE "Sears:Betsy (1802–1819)" \f "Name" \b } was born in Camillus{ XE "USA, New York, Onondaga, Camillus:(43.0392° N, 76.3041° W):Sears, Betsy (1802–1819)" \f "Place" } on 13th November 1802. She died on 7th August 1819, at the age of 16.
- f VI. **Adelaide Sears**{ XE "Sears:Adelaide (1805–1876)" \f "Name" \b } was born in Camillus{ XE "USA, New York, Onondaga, Camillus:(43.0392° N, 76.3041° W):Sears, Adelaide (1805–1876)" \f "Place" } on 14th April 1805. She died on 31st August 1876, at the age of 71.

Family of John Sears and Phebe Lusk{ TC "John Sears and Phebe Lusk" \I 4 \f C}

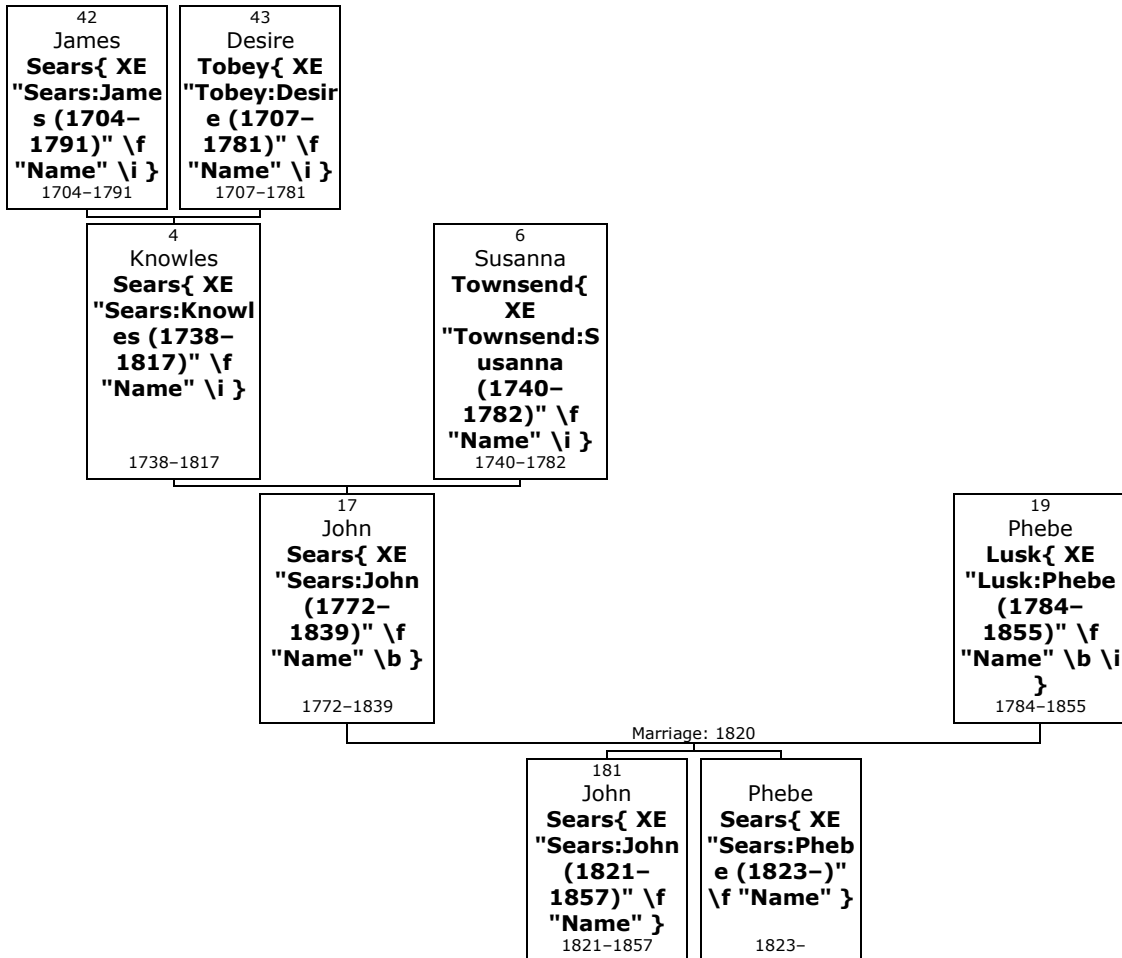

²⁹ Ancestry.com, U.S., Find A Grave Index, 1600s-Current (Provo, UT, USA, Ancestry.com Operations, Inc., 2012), Ancestry.com, Record for Susan Ladu. <http://search.ancestry.com/cgi-bin/sse.dll?db=60525&h=16544807&indiv=try>.

³⁰ Ancestry.com, New York, State Census, 1875 (Provo, UT, USA, Ancestry.com Operations, Inc., 2013), Ancestry.com.

Here are the details about **John Sears**{ XE "Sears:John (1772-1839)" \f "Name" \b } second marriage, with Phebe Lusk. You can read more about John on page 32.

- 19.** At the age of 47, John Sears married **Phebe Lusk**{ XE "Lusk:Phebe (1784-1855)" \f "Name" \b \i } on Thursday, 20th April 1820, when she was 35 years old. They had two children: John (1821-1857) and Phebe (1823-).

Phebe was born in perh, Camillus, Onondaga, New York,{ XE "USA, New York, Onondaga, Camillus, perh: :Lusk, Phebe (1784-1855)" \f "Place" } on Friday, 27th August 1784. She reached 70 years of age and died on 28th April 1855.

Children of John Sears and Phebe Lusk:

- + 181 m I. **John⁵ Sears**{ XE "Sears:John (1821-1857)" \f "Name" } was born in Camillus{ XE "USA, New York, Onondaga, Camillus:(43.0392° N, 76.3041° W):Sears, John (1821-1857)" \f "Place" } on 15th January 1821.^[31] He died on 29th January 1857, at the age of 36.
- f II. **Phebe Sears**{ XE "Sears:Phebe (1823-)" \f "Name" \b } was born in Camillus{ XE "USA, New York, Onondaga, Camillus:(43.0392° N, 76.3041° W):Sears, Phebe (1823-)" \f "Place" } on 12th August 1823.

Abijah Sears{ TC "Abijah Sears" \I 3 \f C}

- 20.** **Abijah⁴ Sears**{ XE "Sears:Abijah (1774-1839)" \f "Name" \b } (*Susanna³ Townsend*) was born on Monday, 8th August 1774, in Danbury, Fairfield, Connecticut, USA{ XE "USA, Connecticut, Fairfield, Danbury:(41.3948° N, 73.454° W):Sears, Abijah (1774-1839)" \f "Place" }.^[32] He was the son of Knowles Sears{ XE "Sears:Knowles (1738-1817)" \f "Name" \i } (4) and Susanna Townsend{ XE "Townsend:Susanna (1740-1782)" \f "Name" \i } (6).

His estate was probated on 25th July 1837, in Chautauqua, New York{ XE "USA, New York, Chautauqua:(42.3015° N, 79.4125° W):Sears, Abijah (1774-1839)" \f "Place" }.^[32] Abijah died on 1st September 1839, at the age of 65.^[32] Hector, Seneca Lake, NY.

<https://www.wikitree.com/wiki/Sears-4655>

!S.P. May p.277 Abijah Sears removed to Eaton, Mad. co., NY, and later to the head of Seneca lake, perhaps to Hector, where he died a few years later.

!

!The Town of Van Buren, p. 733 Vol I. Chapter XXXIII Ononadaga's centennial:gleanings of a century The following list of property owners on each lot in Van Buren in 1825 is worthy of preservation in this connection: Lot 27 Alvin Bostwick, John Clark, jr., John Crumb, Alpheus Earll, David How, Jonathan How, John Inglesbee, Michael Redman, Abijah Sears, Hiram Warner, Andrew Warner.

!

!1800 United States Federal Census about Abijah Sears Home in 1800 (City, County, State): Rensselaerville, Albany, New York Free White Persons - Males - Under 10:2 Free White Persons - Males - 26 thru 44:1 Free White Persons - Females - 26 thru 44:1 Number of Household Members Under 16:2 Number of Household Members Over 25:2 Number of Household Members:4 I wonder about this 1840 census entry- conflict with death date

!

!1840 United States Federal Census about Abijah Sears Home in 1840 (City, County, State): Danby, Tompkins, New York Free White Persons - Males - 10 thru 14:1 Free White Persons - Males - 60 thru 69:1 Free White Persons - Females - 10 thru 14:1 Free White Persons - Females - 15 thru 19:3 Persons Employed in Agriculture:1 Free White Persons - Under 20:5 Total Free White Persons:6 Total All Persons - Free White, Free Colored, Slaves:6

Marriages with Anna Browne, Catharine Boughton (Page 37) and Sally Hendricks (Page 38) are known.

³¹ Ancestry.com, 1850 United States Federal Census (Provo, UT, USA, Ancestry.com Operations, Inc., 2009), Ancestry.com, Year: 1850; Census Place: Wolcott, Wayne, New York; Roll: M432_613; Page: 524B; Image: 458.

³² Ancestry.com, New York, Wills and Probate Records, 1659-1999 (Provo, UT, USA, Ancestry.com Operations, Inc., 2015), Ancestry.com, Probate Records, 1818-1911; Author: New York. Surrogate's Court (Chautauqua County); Probate Place: Chautauqua, New York.

[Source citation includes one media item]

Family of Abijah Sears and Anna Browne{ TC "Abijah Sears and Anna Browne" \I 4 \f C}

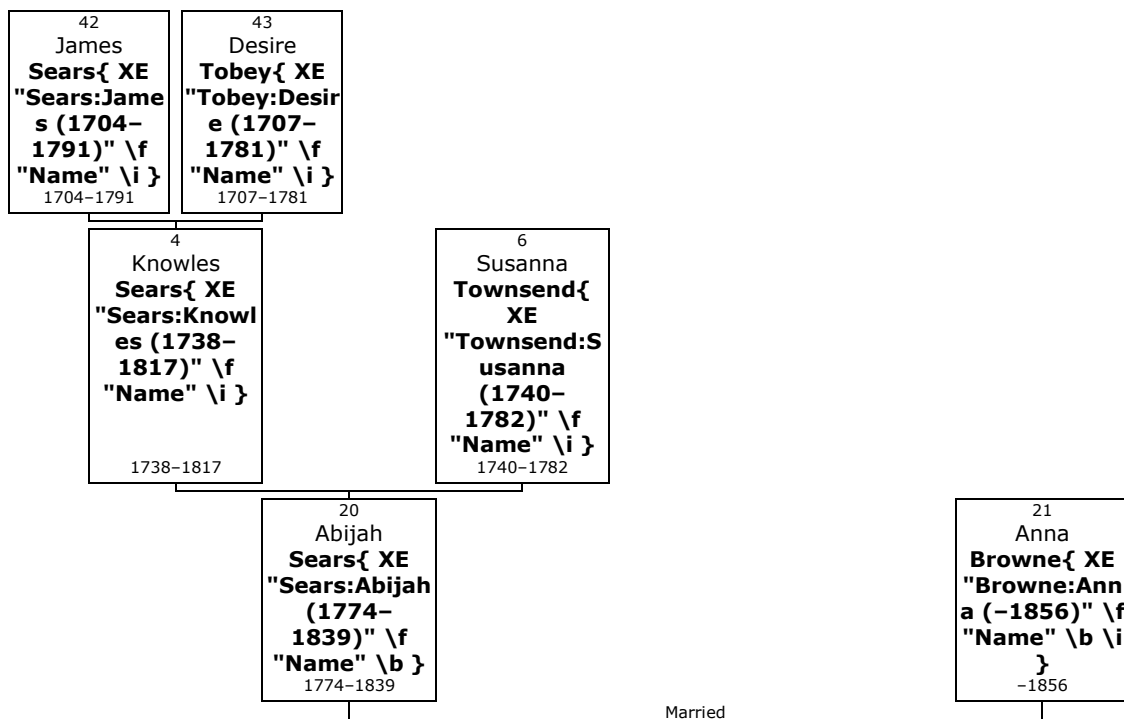

Here are the details about **Abijah Sears**{ XE "Sears:Abijah (1774-1839)" \f "Name" \b } first marriage, with Anna Browne. You can read more about Abijah on page 35.

- 21.** Abijah Sears married **Anna Browne**{ XE "Browne:Anna (-1856)" \f "Name" \b \i }. They had no known children.

Anna died in Newark Valley, Tioga, New York,{ XE "USA, New York, Tioga, Newark Valley:(42.2237° N, 76.1833° W):Browne, Anna (-1856)" \f "Place" } in 1856.

Family of Abijah Sears and Catharine Boughton{ TC "Abijah Sears and Catharine Boughton" \I 4 \f C}

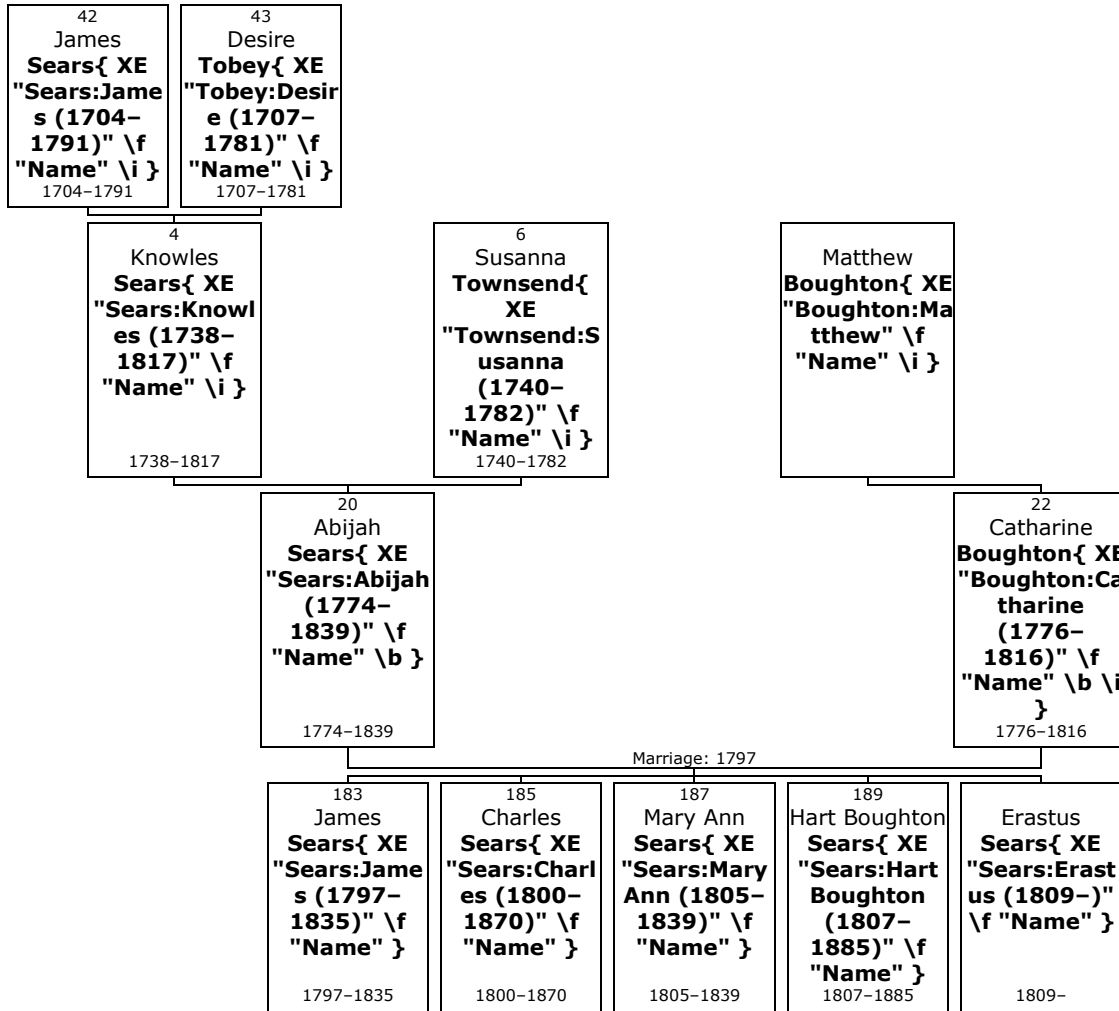

Here are the details about **Abijah Sears**{ XE "Sears:Abijah (1774-1839)" \f "Name" \b } second marriage, with Catharine Boughton. You can read more about Abijah on page 35.

22. Abijah Sears married **Catharine Boughton**{ XE "Boughton:Catharine (1776-1816)" \f "Name" \b \i } on Sunday, 8th January 1797, in Danbury{ XE "USA, Connecticut, Fairfield, Danbury:(41.3948° N, 73.454° W):Sears, Abijah (1774-1839)" \f "Place" }. They had five children: James (1797-1835), Charles (1800-1870), Mary (1805-1839), Hart (1807-1885) and Erastus (1809-).

Catharine was born in perh, Danbury,{ XE "USA, Connecticut, Fairfield, Danbury, perh: :Boughton, Catharine (1776-1816)" \f "Place" } in 1776. She was the daughter of Matthew Boughton{ XE "Boughton:Matthew" \f "Name" \i }.

Catharine reached 40 years of age and died in May 1816.

Children of Abijah Sears and Catharine Boughton:

- + 183 m I. **James⁵ Sears**{ XE "Sears:James (1797-1835)" \f "Name" } was born in Eaton, Madison, New York,{ XE "USA, New York, Madison, Eaton:(42.8497° N, 75.6122° W):Sears, James (1797-1835)" \f "Place" } on 12th May 1797. He died in Danby, Tompkins,{ XE "USA, New York, Tompkins, Danby:(42.3522° N, 76.4811° W):Sears, James (1797-1835)" \f "Place" } on 29th June 1835, at the age of 38.
- + 185 m II. **Charles Sears**{ XE "Sears:Charles (1800-1870)" \f "Name" } was born in Eaton{ XE "USA, New York, Madison, Eaton:(42.8497° N, 75.6122° W):Sears, Charles (1800-1870)" \f "Place" } in 1800. He died in Allen, Hillsdale, Michigan,{ XE "USA, Michigan, Hillsdale, Allen:(41.957° N, 84.7677° W):Sears, Charles (1800-1870)" \f "Place" } in 1870 at the age of 70.

- + 187 f III. **Mary Ann Sears**{ XE "Sears:Mary Ann (1805–1839)" \f "Name" } was born in Eaton{ XE "USA, New York, Madison, Eaton:(42.8497° N, 75.6122° W):Sears, Mary Ann (1805–1839)" \f "Place" } on 16th April 1805. She died on 18th March 1839, at the age of 33.
- + 189 m IV. **Hart Boughton Sears**{ XE "Sears:Hart Boughton (1807–1885)" \f "Name" } was born in Eaton{ XE "USA, New York, Madison, Eaton:(42.8497° N, 75.6122° W):Sears, Hart Boughton (1807–1885)" \f "Place" } on 15th August 1807.^[33, 34–35] He died in Newark Valley, Tioga,{ XE "USA, New York, Tioga, Newark Valley:(42.2237° N, 76.1833° W):Sears, Hart Boughton (1807–1885)" \f "Place" } on 11th May 1885, at the age of 77.^[33]
- m V. **Erastus Sears**{ XE "Sears:Erastus (1809–)" \f "Name" \b } was born in Eaton{ XE "USA, New York, Madison, Eaton:(42.8497° N, 75.6122° W):Sears, Erastus (1809–)" \f "Place" } in 1809.

Family of Abijah Sears and Sally Hendricks{ TC "Abijah Sears and Sally Hendricks" \I 4 \f C}

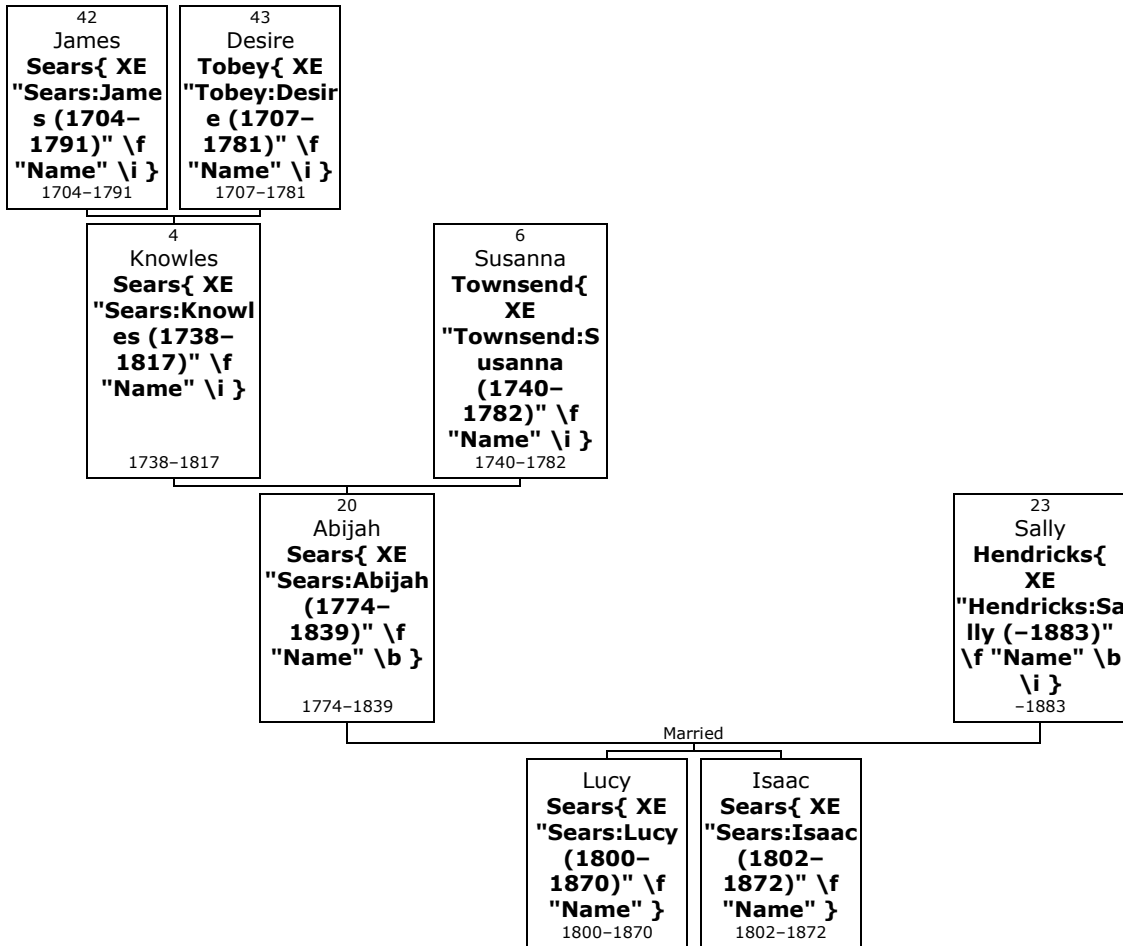

Here are the details about **Abijah Sears**{ XE "Sears:Abijah (1774–1839)" \f "Name" \b } third marriage, with Sally Hendricks. You can read more about Abijah on page 35.

- 23.** Abijah Sears married **Sally Hendricks**{ XE "Hendricks:Sally (-1883)" \f "Name" \b \i }. They had two children: Lucy (1800–1870) and Isaac (1802–1872).

Sally died in March 1883.

³³ Ancestry.com, U.S., Find A Grave Index, 1600s-Current (Provo, UT, USA, Ancestry.com Operations, Inc., 2012), Ancestry.com.

³⁴ Ancestry.com, New York, State Census, 1875 (Provo, UT, USA, Ancestry.com Operations, Inc., 2013), Ancestry.com.

³⁵ Ancestry.com and The Church of Jesus Christ of Latter-day Saints, 1880 United States Federal Census (Provo, UT, USA, Ancestry.com Operations Inc, 2010), Ancestry.com, Year: 1880; Census Place: Newark Valley, Tioga, New York; Roll: 937; Family History Film: 1254937; Page: 125B; Enumeration District: 209; Image: 0250.

Children of Abijah Sears and Sally Hendricks:

- f I. **Lucy⁵ Sears**{ XE "Sears:Lucy (1800–1870)" \f "Name" \b } was born in Danby, Tompkins, New York,{ XE "USA, New York, Tompkins, Danby:(42.3522° N, 76.4811° W):Sears, Lucy (1800–1870)" \f "Place" } in 1800. She died in 1870 at the age of 70.
- m II. **Isaac Sears**{ XE "Sears:Isaac (1802–1872)" \f "Name" \b } was born in perh, Danby,{ XE "USA, New York, Tompkins, Danby, perh: :Sears, Isaac (1802–1872)" \f "Place" } in 1802. He died in 1872 at the age of 70.

Family of Desire Sears and Caleb Gregory{ TC "Desire Sears and Caleb Gregory" \I 3 \f C}

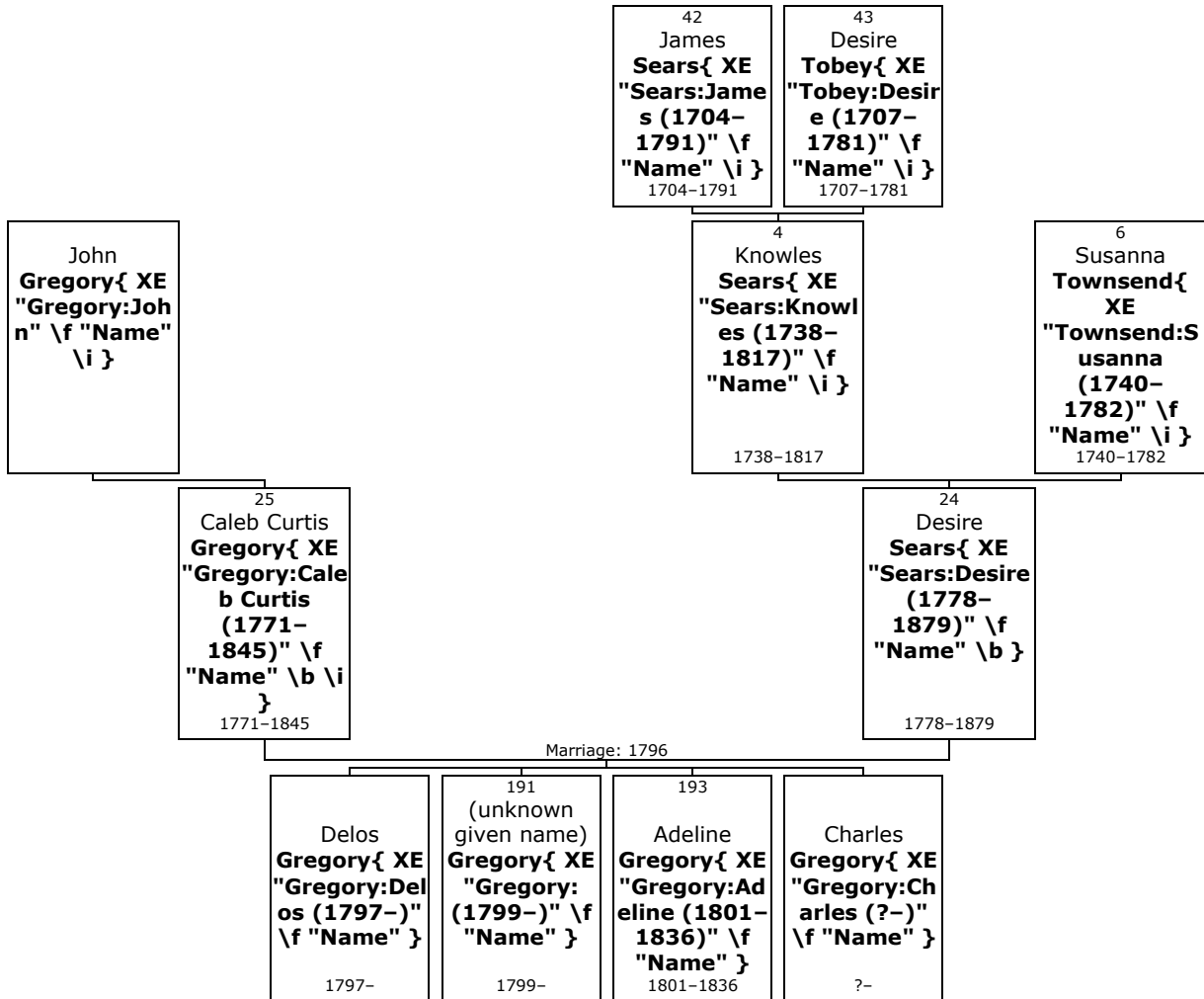

24. Desire⁴ Sears{ XE "Sears:Desire (1778–1879)" \f "Name" \b } (*Susanna³ Townsend*) was born on Monday, 25th May 1778, in Ridgefield, Fairfield, Connecticut, USA{ XE "USA, Connecticut, Fairfield, Ridgefield:(41.2815° N, 73.4982° W):Sears, Desire (1778–1879)" \f "Place" }. She was the daughter of Knowles Sears{ XE "Sears:Knowles (1738–1817)" \f "Name" \i } (4) and Susanna Townsend{ XE "Townsend:Susanna (1740–1782)" \f "Name" \i } (6).

Desire died in Danbury{ XE "USA, Connecticut, Fairfield, Danbury:(41.3948° N, 73.454° W):Sears, Desire (1778–1879)" \f "Place" } on 17th February 1879, at the age of 100. She was buried in 2 mi NE, Danbury{ XE "USA, Connecticut, Fairfield, Danbury, 2 mi NE: :Sears, Desire (1778–1879)" \f "Place" }.

S P May No 760 p. 177 b., m., d. at the age of 100 years 8 mos 23 days Buried in the cemetery two miles northeast of Danbury.

<https://www.wikitree.com/wiki/Sears-4765>

* No. 1010, pg 408 - [<https://archive.org/details/stjohngenealogyd00alex> The St. John genealogy; descendants of Matthias St. John, of Dorchester, Massachusetts, 1634, of Windsor, Connecticut, 1640, of

Wethersfield, Connecticut, 1643-1645, and Norwalk, Connecticut, 1650] by Orlin St. John Alexander
Published 1907

- 25.** At the age of 18, Desire married **Caleb Curtis Gregory**{ XE "Gregory:Caleb Curtis (1771-1845)" \f "Name" \b \i } on Sunday, 13th November 1796, in Westchester, New York,{ XE "USA, New York, Westchester:(41.1536° N, 73.754° W):Sears, Desire (1778-1879)" \f "Place" } when he was 25 years old. They had four children: Delos (1797-), (unknown given name) (1799-), Adeline (1801-1836) and Charles (?-).

Caleb Curtis was born in Danbury, Fairfield, Connecticut,{ XE "USA, Connecticut, Fairfield, Danbury:(41.3948° N, 73.454° W):Gregory, Caleb Curtis (1771-1845)" \f "Place" } on Thursday, 18th July 1771. He was the son of John Gregory{ XE "Gregory:John" \f "Name" \i }.

Caleb Curtis reached 74 years of age and died on 1st December 1845.

Children of Desire Sears and Caleb Curtis Gregory:

- | | | |
|---|-----|--|
| | m | I. Delos⁵ Gregory { XE "Gregory:Delos (1797-)" \f "Name" \b } was born in lives, Danbury, Fairfield, Connecticut,{ XE "USA, Connecticut, Fairfield, Danbury, lives: :Gregory, Delos (1797-)" \f "Place" } in 1797. |
| + | 191 | f II. (unknown given name) Gregory { XE "Gregory: (1799-)" \f "Name" } was born in 1799. |
| + | 193 | f III. Adeline Gregory { XE "Gregory:Adeline (1801-1836)" \f "Name" } was born in Danbury{ XE "USA, Connecticut, Fairfield, Danbury:(41.3948° N, 73.454° W):Gregory, Adeline (1801-1836)" \f "Place" } on 21 st February 1801. She died in Jackson, Michigan,{ XE "USA, Michigan, Jackson:(42.2479° N, 84.4245° W):Gregory, Adeline (1801-1836)" \f "Place" } on 17 th December 1836, at the age of 35. |
| | m | IV. Charles Gregory { XE "Gregory:Charles (?-)" \f "Name" \b } was born in Ridgefield{ XE "USA, Connecticut, Fairfield, Ridgefield:(41.2815° N, 73.4982° W):Gregory, Charles (?-)" \f "Place" } on 3 rd August. |

Family of Charles Sears and Betsy Smith{ TC "Charles Sears and Betsy Smith" \I 3 \f C}

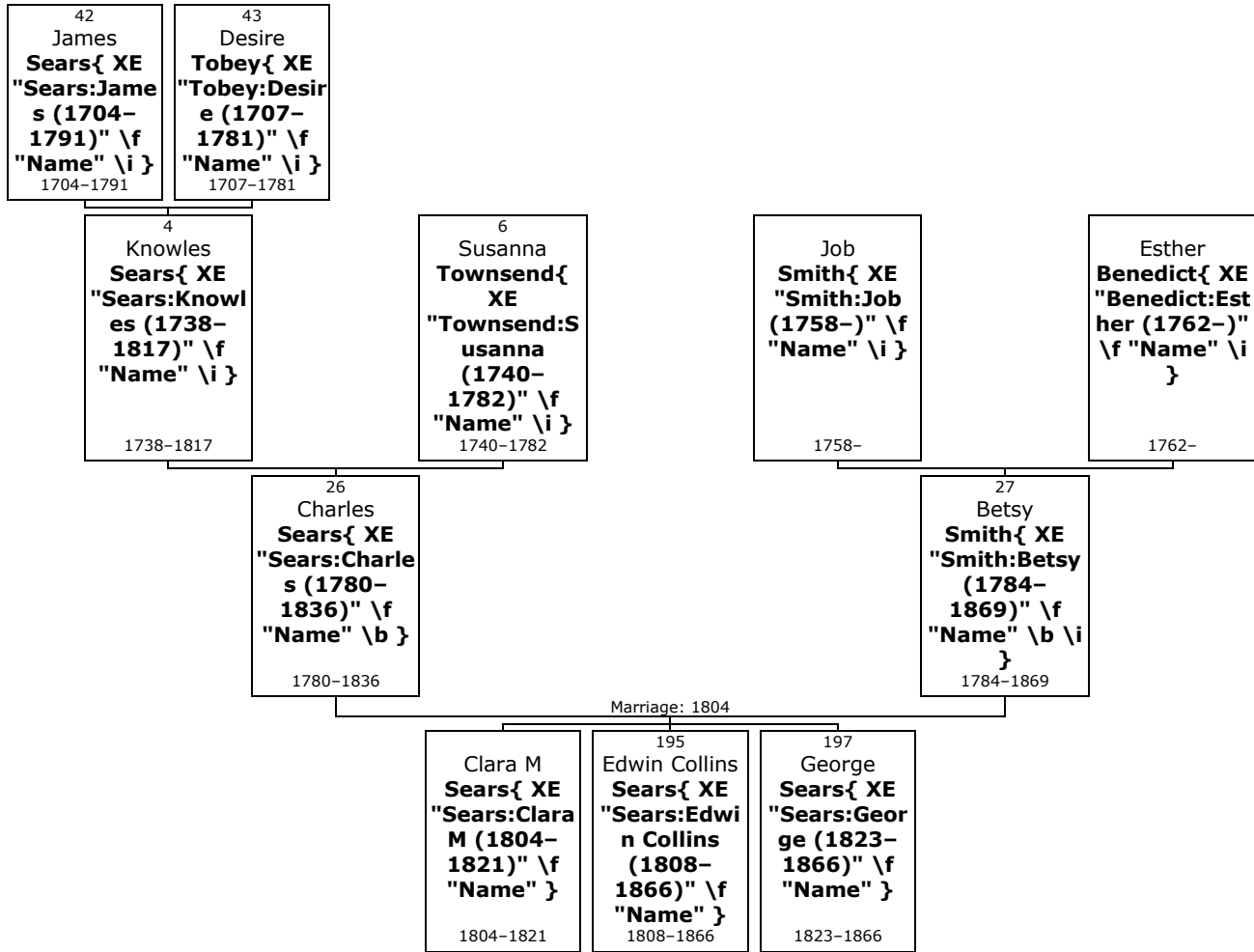

26. **Charles⁴ Sears**{ XE "Sears:Charles (1780-1836)" \f "Name" \b } (*Susanna³ Townsend*) was born on Thursday, 3rd August 1780, in Danbury, Fairfield, Connecticut, USA{ XE "USA, Connecticut, Fairfield, Danbury:(41.3948° N, 73.454° W):Sears, Charles (1780-1836)" \f "Place" }.^[36, 37] He was the son of Knowles Sears{ XE "Sears:Knowles (1738-1817)" \f "Name" \i } (4) and Susanna Townsend{ XE "Townsend:Susanna (1740-1782)" \f "Name" \i } (6).

Charles died in Ridgefield{ XE "USA, Connecticut, Fairfield, Ridgefield:(41.2815° N, 73.4982° W):Sears, Charles (1780-1836)" \f "Place" } on 22nd April 1836, at the age of 55.^[36, 37] He was buried in Ridgefield{ XE "USA, Connecticut, Fairfield, Ridgefield:(41.2815° N, 73.4982° W):Sears, Charles (1780-1836)" \f "Place" }.^[36]

!S P May p.278 Charles removed to Camillus, Onon. co., NY but returned, and died in Ridgefield; he was a farmer, and was found dead in a field. He and his wife were buried in Titicus Cemetery, Ridgefield, Fairfield co.

!

!Conn. Rolls, pp.547, 549 #924 Charles Sears, d.22.Apr.1836 ae 55. (b.Danbury, Conn., 3.Aug. 1780, son of Capt.Knowles Sears, 1738-17.June 1817 ae 79, Served in the Revolution, pp.547, 549, m.Susanna Townsend, d.24.Apr.1782 ae 43, gr.son of James Sears, 30.Mch.1704-17. Mch.1791, m.28.May 1730, Desire Tobey, 1707-28.July 1781, gr. gr.son of Silas Sears, 1661-1732, m.1692, Sarah, dau.of Rev. Thomas Crosby & Sarah, 24.Mch..667-20.Mch.1705/06, gr.gr.gr. son of Lieut.Silas Sears, d.13.Jan.1697/98, m.Anna, d.4.Jan. 1725/26, gr.gr.gr.gr.son of Richard Sares, 1590-buried 29.Mch. 1676, m.Dorothy Thacher, buried, 19.Mch.1678/79).

³⁶ Ancestry.com, U.S., Find A Grave Index, 1600s-Current (Provo, UT, USA, Ancestry.com Operations, Inc., 2012), Ancestry.com.

³⁷ Ancestry.com, Connecticut, Deaths and Burials Index, 1650-1934 (Provo, UT, USA, Ancestry.com Operations, Inc., 2011), Ancestry.com.

<https://www.wikitree.com/wiki/Sears-1770>

27. At the age of 23, Charles married **Betsy Smith**{ XE "Smith:Betsy (1784–1869)" \f "Name" \b \i } on Saturday, 17th March 1804, in Ridgefield{ XE "USA, Connecticut, Fairfield, Ridgefield:(41.2815° N, 73.4982° W):Sears, Charles (1780–1836)" \f "Place" } when she was 19 years old.^[36] They had three children: Clara (1804–1821), Edwin (1808–1866) and George (1823–1866).

Betsy was born in Ridgefield{ XE "USA, Connecticut, Fairfield, Ridgefield:(41.2815° N, 73.4982° W):Smith, Betsy (1784–1869)" \f "Place" } on Tuesday, 26th October 1784.^[36] She was the daughter of Job Smith{ XE "Smith:Job (1758–)" \f "Name" \i } and Esther Benedict{ XE "Benedict:Esther (1762–)" \f "Name" \i }.

Betsy reached 84 years of age and died in Ridgefield{ XE "USA, Connecticut, Fairfield, Ridgefield:(41.2815° N, 73.4982° W):Smith, Betsy (1784–1869)" \f "Place" } on 15th August 1869.^[36] She was buried in Ridgefield{ XE "USA, Connecticut, Fairfield, Ridgefield:(41.2815° N, 73.4982° W):Smith, Betsy (1784–1869)" \f "Place" }.^[36]

Children of Charles Sears and Betsy Smith:

- | | | | |
|---|-----|----|--|
| | f | I. | Clara M⁵ Sears { XE "Sears:Clara M (1804–1821)" \f "Name" \b } was born in Ridgefield{ XE "USA, Connecticut, Fairfield, Ridgefield:(41.2815° N, 73.4982° W):Sears, Clara M (1804–1821)" \f "Place" } on 18 th November 1804. She died on 7 th September 1821, at the age of 16. |
| + | 195 | m | II. Edwin Collins Sears { XE "Sears:Edwin Collins (1808–1866)" \f "Name" } was born in Ridgefield{ XE "USA, Connecticut, Fairfield, Ridgefield:(41.2815° N, 73.4982° W):Sears, Edwin Collins (1808–1866)" \f "Place" } on 17 th January 1808. ^[37, 38] He died in Danbury{ XE "USA, Connecticut, Fairfield, Danbury:(41.3948° N, 73.454° W):Sears, Edwin Collins (1808–1866)" \f "Place" } on 7 th June 1866, at the age of 58. ^[37, 38] |
| + | 197 | m | III. George Sears { XE "Sears:George (1823–1866)" \f "Name" } was born in Camillus, Onondaga, New York,{ XE "USA, New York, Onondaga, Camillus:(43.0392° N, 76.3041° W):Sears, George (1823–1866)" \f "Place" } on 12 th March 1823. ^[36, 37, 39] He died in Danbury, Fairfield, Connecticut,{ XE "USA, Connecticut, Fairfield, Danbury:(41.3948° N, 73.454° W):Sears, George (1823–1866)" \f "Place" } on 8 th November 1866, at the age of 43. ^[36, 37] |

³⁸ Ancestry.com, Connecticut, Hale Cemetery Inscriptions and Newspaper Notices, 1629-1934 (Provo, UT, USA, Ancestry.com Operations, Inc., 2012), Ancestry.com.

³⁹ Ancestry.com, 1850 United States Federal Census (Provo, UT, USA, Ancestry.com Operations, Inc., 2009), Ancestry.com, Year: 1850; Census Place: Ridgefield, Fairfield, Connecticut; Roll: M432_37; Page: 180B; Image: 363.

Family of Charity Sears and Stephen Crosby{ TC "Charity Sears and Stephen Crosby" \i 3 \f C}

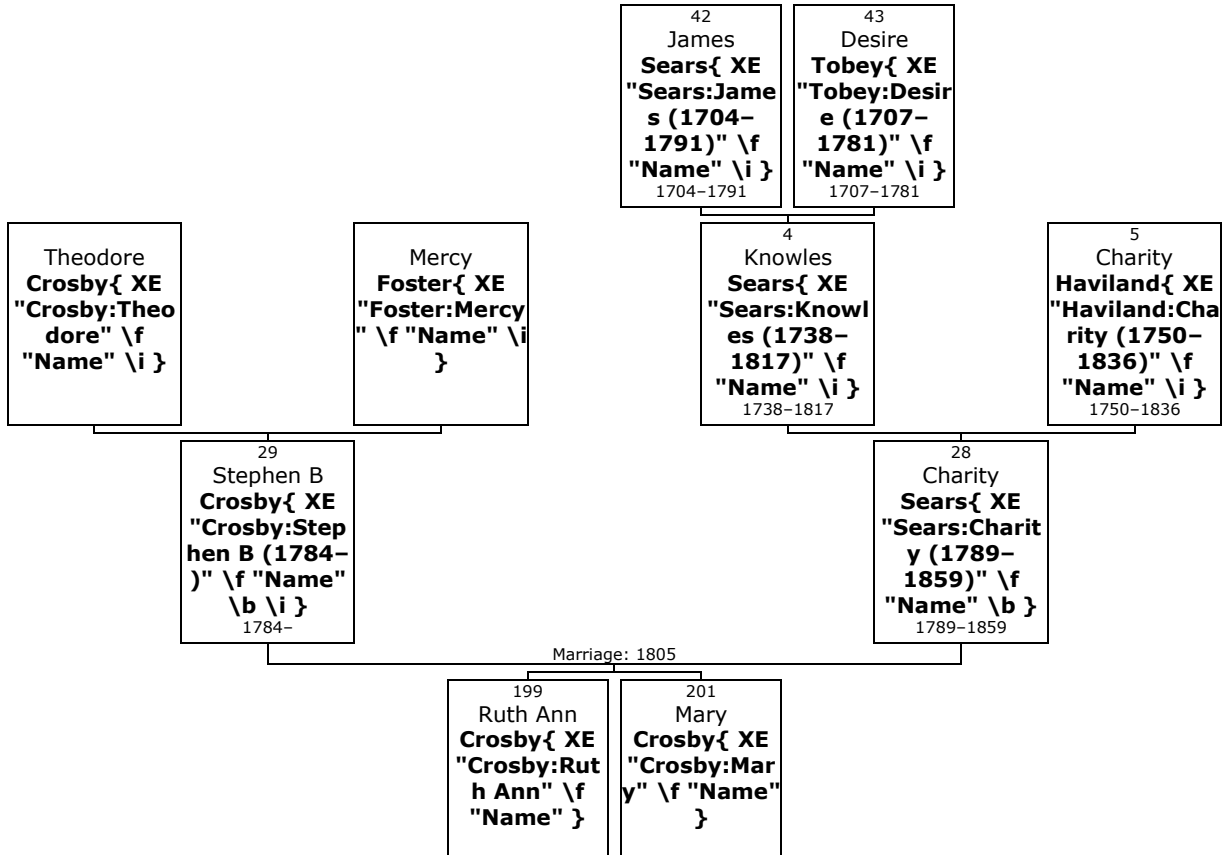

28. **Charity⁴ Sears**{ XE "Sears:Charity (1789-1859)" \f "Name" \b } (*Capt Knowles³, James²*) was born on Friday, 14th August 1789, in Ridgefield, Fairfield, Connecticut, USA{ XE "USA, Connecticut, Fairfield, Ridgefield:(41.2815° N, 73.4982° W):Sears, Charity (1789-1859)" \f "Place" }.^[40] She was the daughter of Knowles Sears{ XE "Sears:Knowles (1738-1817)" \f "Name" \i } (4) and Charity Haviland{ XE "Haviland:Charity (1750-1836)" \f "Name" \i } (5).

Charity died in Grand Rapids, Kent, Michigan,{ XE "USA, Michigan, Kent, Grand Rapids:(42.9634° N, 85.6681° W):Sears, Charity (1789-1859)" \f "Place" } in 1859 at the age of 69.^[40] She was buried in Grand Rapids{ XE "USA, Michigan, Kent, Grand Rapids:(42.9634° N, 85.6681° W):Sears, Charity (1789-1859)" \f "Place" }.^[40]

S P May P. 176

29. At the age of 16, Charity married **Stephen B Crosby**{ XE "Crosby:Stephen B (1784-)" \f "Name" \b \i } on Sunday, 13th October 1805, when he was 21 years old. They had two daughters: Ruth and Mary.

Stephen B was born in perh, Ridgefield, Fairfield, Connecticut,{ XE "USA, Connecticut, Fairfield, Ridgefield, perh: :Crosby, Stephen B (1784-)" \f "Place" } on Saturday, 19th June 1784. He was the son of Theodore Crosby{ XE "Crosby:Theodore" \f "Name" \i } and Mercy Foster{ XE "Foster:Mercy" \f "Name" \i }.

Daughters of Charity Sears and Stephen B Crosby:

- + 199 f I. **Ruth Ann⁵ Crosby**{ XE "Crosby:Ruth Ann" \f "Name" }.
- + 201 f II. **Mary Crosby**{ XE "Crosby:Mary" \f "Name" }.

⁴⁰ Ancestry.com, U.S., Find A Grave Index, 1600s-Current (Provo, UT, USA, Ancestry.com Operations, Inc., 2012), Ancestry.com.

Family of Elizabeth Sears and Joseph Brush{ TC "Elizabeth Sears and Joseph Brush" \I 3 \f C}

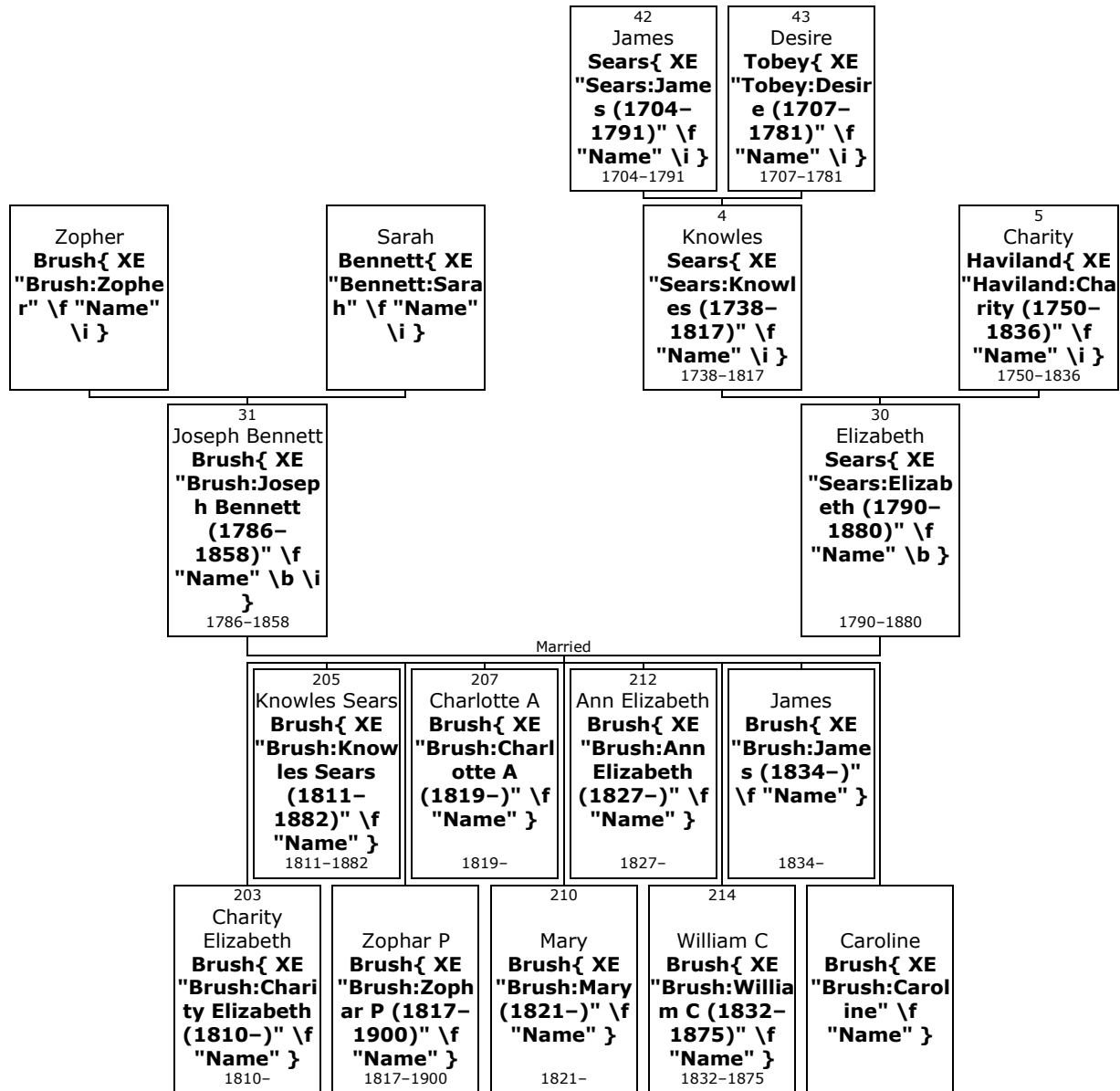

- 30. Elizabeth⁴ Sears**{ XE "Sears:Elizabeth (1790-1880)" \f "Name" \b } (*Capt Knowles³, James²*) was born on Friday, 26th November 1790, in Ridgefield, Fairfield, Connecticut, USA{ XE "USA, Connecticut, Fairfield, Ridgefield:(41.2815° N, 73.4982° W):Sears, Elizabeth (1790-1880)" \f "Place" }.^[41] She was the daughter of Knowles Sears{ XE "Sears:Knowles (1738-1817)" \f "Name" \i } (4) and Charity Haviland{ XE "Haviland:Charity (1750-1836)" \f "Name" \i } (5).

Elizabeth died in 1880 at the age of 89.^[41] She was buried in Huron, Wayne County, New York{ XE "USA, New York, Wayne County, Huron:(43.2333° N, 76.8803° W):Sears, Elizabeth (1790-1880)" \f "Place" }.^[41]

<http://chrisman.org/pedigree/out75.htm> accessed 31 Aug 2019 Nathaniel Brush Father: Philip Brush <out78.htm> Mother: Ruth Brush <out78.htm> Birth: 10 NOV 1787 Huntingdon, Long Island, New York 1 Death: 1840 New York City, New York 2 m: Elizabeth Sears <out75.htm> (-7 MAY 1815) on 3 AUG 1805 Children: Sally Platt Brush <out74.htm> (25 MAR 1810-28 NOV 1888) m. Samuel Rice <out64.htm> (9 OCT 1807-21 MAY 1891), children: 1. Caroline Rice (-AFT 1904), 2. Francis P. Rice (15 NOV 1831-13 OCT 1912), 3. Mary Amelia Rice (23 JUL 1834-9 JAN 1900), 4. James Theodore Rice (1836-1912), 5. Lewis H. Rice (28 APR 1839-3 APR 1851), 6. Sarah A. Rice (1840/1841-AFT 1904), 7.

⁴¹ Ancestry.com, U.S., Find A Grave Index, 1600s-Current (Provo, UT, USA, Ancestry.com Operations, Inc., 2012), Ancestry.com.

Rufus Samuel Rice <out40.htm> (31 OCT 1843-28 DEC 1904), 8. Halsey John Rice (1 MAR 1846-12 JUN 1853), 9. Fannie M. Rice (5 FEB 1848-AFT 1904), 10. Henrietta Jane Rice (30 AUG 1850-11 OCT 1852).
 Notes: The parentage of Nathaniel accepted here comes from the research of Richard Sweet Rice, fruits of which has been passed through his son Bill to Jo Rice to me. Records in Research & Leads are consistent with this and were obtained independently, but were insufficient to just to this conclusion. The full records backing this conclusion have yet to be verified by me. Notes: Apparently a number of authors have mistakenly equated her to the Elizabeth Sears born 26 Nov 1790, dau. of Knowles Sears. Sources: [1] @S190@

Research & Leads:* The following notes were found on a now defunct web site -- it appears that it could be referring to the same Nathaniel Brush... "May shows husband as Nathaniel Brush but Descendants of Thomas and Richard Brush of L.I. by Stuart Brush, c. 1982 says May had the wrong Elizabeth. Nathaniel's wife probably was a Sears and perhaps an Elizabeth as in 1810 Nathaniel's father, Philip, nearest neighbors in Ridgefield were Comfort Sears, Knowles Sears and Isaac Sears."* The Elizabeth Sears in question in the above quote was Elizabeth b. 26 Nov 1790, dau. of Knowles Sears (Elizabeth-Knowles-James-Silas-Silas-Richard). The belief of that author is that that Elizabeth Sears actually married Joseph Bennett Brush, b. 26 May 1786 in Huron, NY, d. 30 Apr 1858 Ridgebury, CT.* State papers of Vermont, Vol II: Vermont Charters, P.H. Gobie Press Inc., 1922 (http://freepages.books.rootsweb.com/~teking/orphans/vt_grants.htm) Accessed 31 Aug 2019 , has the Charter of Fletcher Twp., which includes name Nathaniel Brush.* A Nathaniel Brush is found on the tax rolls of the town of Amenia, Dutchess Co., NY, in 1765 & 1766. He is not found there in 1757 or 1767. In 1770, Reubin, Richard and Samuel Brush are there. No Sears are found on those lists. [http://www.ajcockrell.com/census/ameniany/Amenia_1Page30.html]* Suffolk Co., NY finds many Brushes. (<http://www.rootsweb.com/~nysuffol/>) Accessed 31 Aug 2019 Old Huntington Cemetery has several (<http://www.rootsweb.com/~nysuffol/ohcem.html>), with no obvious connection.* As per AF, a Nathaniel Brush b. 5 Jan 1746 d. bef 1794 m. 1 Jan 1775 Hannah Platt, all events in Huntington, Suffolk Co., NY. Note the surname Platt. A son, Stephen Brush, listed as b. c1776 in Huntingdon, LI,NY. This Nathaniel3-Ananias2-Samuel1. However, as a red flag for reliability, also note that AF shows him as a descendant of Stephen Hopkins of the Mayflower, but "Mayflower Families" Vol.6 doesn't even accept the first generation of that purported descent, let alone the incorrect wife of Stephen Hopkins shown there that has since been disproven. Sources: [1] @S190@ [2] @S190@

- 31.** She married **Joseph Bennett Brush**{ XE "Brush:Joseph Bennett (1786-1858)" \f "Name" \b \i }. They had nine children: Charity (1810-), Knowles (1811-1882), Zophar (1817-1900), Charlotte (1819-), Mary (1821-), Ann (1827-), William (1832-1875), James (1834-) and Caroline.

Joseph Bennett was born in Huron, Wayne,{ XE "USA, New York, Wayne, Huron:(43.2333° N, 76.8803° W):Brush, Joseph Bennett (1786-1858)" \f "Place" } on Friday, 26th May 1786. He was the son of Zopher Brush{ XE "Brush:Zopher" \f "Name" \i } and Sarah Bennett{ XE "Bennett:Sarah" \f "Name" \i }.

Joseph Bennett reached 71 years of age and died on 30th April 1858. Ridgebury, CT.

!May shows husband as Nathaniel Brush but Descendants of Thomas and Richard Brush of L.I. by Stuart Brush, c. 1982 says May had the wrong Elizabeth. Nathaniel's wife probably was a Sears and perhaps an Elizabeth as in 1810 Nathaniel's father, Philip, nearest neighbors in Ridgefield were Comfort Sears, Knowles Sears and Isaac Sears.

Children of Elizabeth Sears and Joseph Bennett Brush:

- + 203 f I. **Charity Elizabeth⁵ Brush**{ XE "Brush:Charity Elizabeth (1810-)" \f "Name" } was born in 1810.
- + 205 m II. **Knowles Sears Brush**{ XE "Brush:Knowles Sears (1811-1882)" \f "Name" } was born on 11th August 1811. He died on 15th March 1882, at the age of 70.
- m III. **Zophar P Brush**{ XE "Brush:Zophar P (1817-1900)" \f "Name" \b } was born in January 1817. He died in 1900 at the age of 83.
- + 207 f IV. **Charlotte A Brush**{ XE "Brush:Charlotte A (1819-)" \f "Name" } was born in 1819. She died in Geneva, Walworth, Wisconsin{ XE "USA, Wisconsin, Walworth, Geneva:(42.6205° N, 88.487° W):Brush, Charlotte A (1819-)" \f "Place" }.
- + 210 f V. **Mary Brush**{ XE "Brush:Mary (1821-)" \f "Name" } was born in 1821.

- + 212 f VI. **Ann Elizabeth Brush**{ XE "Brush:Ann Elizabeth (1827-)" \f "Name" } was born on 20th May 1827.^[42]
- + 214 m VII. **William C Brush**{ XE "Brush:William C (1832-1875)" \f "Name" } was born in 1832. He died in 1875 at the age of 43.
- m VIII. **James Brush**{ XE "Brush:James (1834-)" \f "Name" \b } was born in 1834.
- f IX. **Caroline Brush**{ XE "Brush:Caroline" \f "Name" \b }.

Family of David Sears and Sally Morris{ TC "David Sears and Sally Morris" \I 3 \f C}

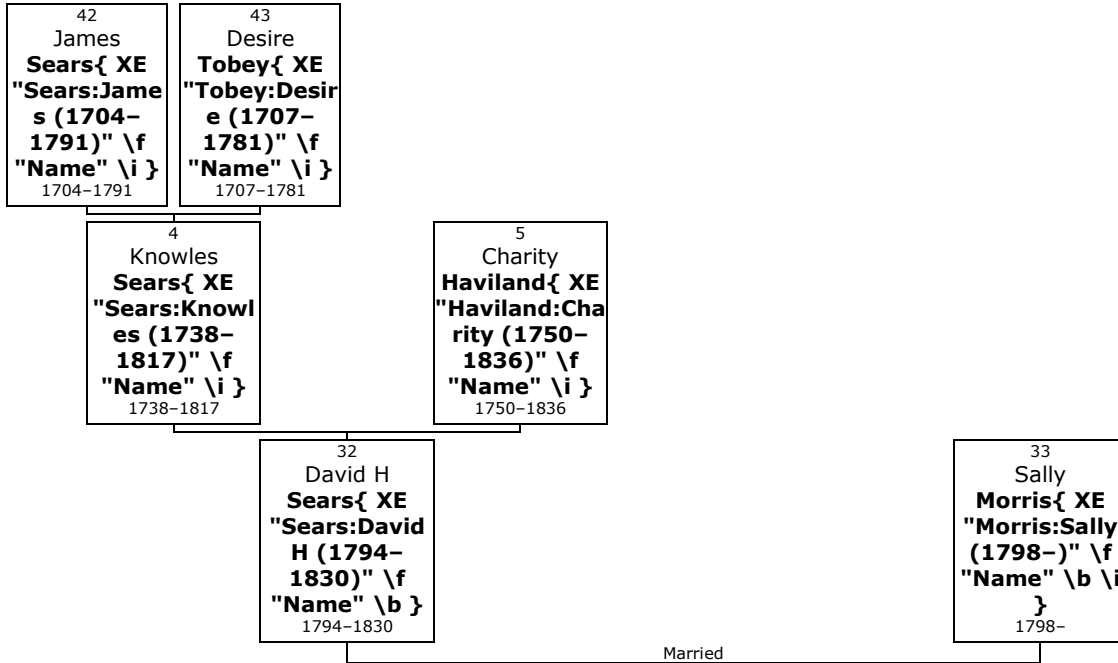

- 32. David H⁴ Sears**{ XE "Sears:David H (1794-1830)" \f "Name" \b } (*Capt Knowles³, James²*) was born in 1794 in Ridgefield, Fairfield, Connecticut, USA{ XE "USA, Connecticut, Fairfield, Ridgefield:(41.2815° N, 73.4982° W):Sears, David H (1794-1830)" \f "Place" }. He was the son of Knowles Sears{ XE "Sears:Knowles (1738-1817)" \f "Name" \i } (4) and Charity Haviland{ XE "Haviland:Charity (1750-1836)" \f "Name" \i } (5).

David H died in Danbury{ XE "USA, Connecticut, Fairfield, Danbury:(41.3948° N, 73.454° W):Sears, David H (1794-1830)" \f "Place" } on 26th September 1830, at the age of 36. He was buried in 35-11-17, Milltown Cemetery, Southeast, Putnam, New York{ XE "USA, New York, Putnam, Southeast, Milltown Cemetery, 35-11-17: :Sears, David H (1794-1830)" \f "Place" }.

S P May No 764, gr-st

<https://www.wikitree.com/wiki/Sears-4758>

David H Sears B: 1794 in Ridgefield, CT D: 26 Sep 1830 in Danbury, CT Sally Morris B: <1798> in Parents Knowles Sears 1738-1817 Charity Haviland 1750-1836

1820 United States Federal Census <http://www.ancestry.com/search/db.aspx?dbid=7734> Name: David H Sears [David M Sears] Home in 1820 (City, County, State): Ridgefield, Fairfield, Connecticut Enumeration Date: August 7, 1820 Free White Persons - Males - 16 thru 25: 1 Free White Persons - Females - 16 thru 25: 1 Number of Persons - Engaged in Agriculture: 1 Total Free White Persons: 2 Total All Persons - White, Slaves, Colored, Other: 2

- 33.** He married **Sally Morris**{ XE "Morris:Sally (1798-)" \f "Name" \b \i }. They had no known children.

Sally was born in perh, Ridgefield, Fairfield, Connecticut,{ XE "USA, Connecticut, Fairfield, Ridgefield, perh: :Morris, Sally (1798-)" \f "Place" } in 1798.

⁴² Ancestry.com, New York, State Census, 1855 (Provo, UT, USA, Ancestry.com Operations, Inc., 2013), Ancestry.com.

Children{ TC "Children" \ I 2 \ f C }

Family of Angeline Sears and Ebenezer Jones{ TC "Angeline Sears and Ebenezer Jones" \ I 3 \ f C }

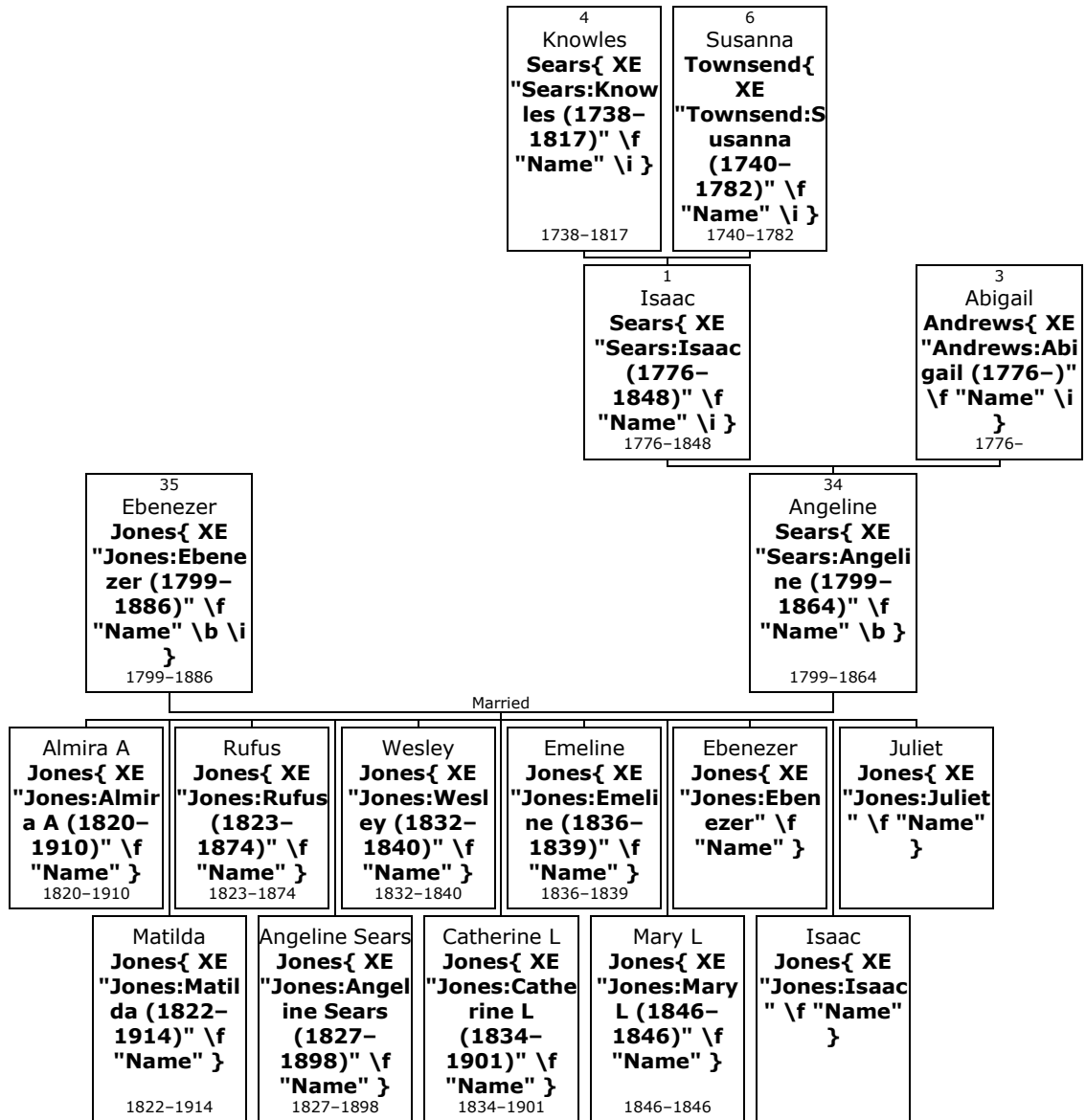

34. **Angeline⁵ Sears**{ XE "Sears:Angeline (1799-1864)" \f "Name" \b } (*Isaac⁴, Susanna³ Townsend*) was born in 1799 in perh, Danbury, Fairfield, Connecticut, USA{ XE "USA, Connecticut, Fairfield, Danbury, perh: :Sears, Angeline (1799-1864)" \f "Place" }.^[43] She was the daughter of Isaac Sears{ XE "Sears:Isaac (1776-1848)" \f "Name" \i } (1) and Abigail Andrews{ XE "Andrews:Abigail (1776-)" \f "Name" \i } (3).

Angeline died in Ballston Spa, Saratoga, New York,{ XE "USA, New York, Saratoga, Ballston Spa:(43.0009° N, 73.849° W):Sears, Angeline (1799-1864)" \f "Place" } on 11th January 1864, at the age of 65.^[43] She was buried in Ballston Spa{ XE "USA, New York, Saratoga, Ballston Spa:(43.0009° N, 73.849° W):Sears, Angeline (1799-1864)" \f "Place" }.^[43]

S P May No 1664

35. She married **Ebenezer Jones**{ XE "Jones:Ebenezer (1799-1886)" \f "Name" \b \i }.^[43] They had eleven children: Almira (1820-1910), Matilda (1822-1914), Rufus (1823-1874), Angeline (1827-1898), Wesley

⁴³ Ancestry.com, U.S., Find A Grave Index, 1600s-Current (Provo, UT, USA, Ancestry.com Operations, Inc., 2012), Ancestry.com.

(1832–1840), Catherine (1834–1901), Emeline (1836–1839), Mary (1846–1846), Ebenezer, Isaac and Juliet.

Ebenezer was born in Dutchess{ XE "USA, New York, Dutchess:(41.7645° N, 73.7472° W):Jones, Ebenezer (1799–1886)" \f "Place" } in 1799.^[43] He reached 87 years of age and died in Ballston Spa, Saratoga,{ XE "USA, New York, Saratoga, Ballston Spa:(43.0009° N, 73.849° W):Jones, Ebenezer (1799–1886)" \f "Place" } on 26th January 1886.^[43] Ebenezer was buried in Ballston Spa{ XE "USA, New York, Saratoga, Ballston Spa:(43.0009° N, 73.849° W):Jones, Ebenezer (1799–1886)" \f "Place" }.^[43]

Children of Angeline Sears and Ebenezer Jones:

- f I. **Almira A⁶ Jones**{ XE "Jones:Almira A (1820–1910)" \f "Name" \b } was born in Schoharie{ XE "USA, New York, Schoharie:(42.591° N, 74.4394° W):Jones, Almira A (1820–1910)" \f "Place" } on 14th December 1820.^[43] She died in Voorheesville, Albany County,{ XE "USA, New York, Albany County, Voorheesville:(42.654° N, 73.9287° W):Jones, Almira A (1820–1910)" \f "Place" } on 13th August 1910, at the age of 89.^[43] Almira A was buried in Guilderland{ XE "USA, New York, Albany County, Guilderland:(42.7044° N, 73.912° W):Jones, Almira A (1820–1910)" \f "Place" }.^[43]
- f II. **Matilda Jones**{ XE "Jones:Matilda (1822–1914)" \f "Name" \b } was born in Schoharie{ XE "USA, New York, Schoharie:(42.591° N, 74.4394° W):Jones, Matilda (1822–1914)" \f "Place" } on 22nd August 1822.^[43] She died in Ballston Spa, Saratoga,{ XE "USA, New York, Saratoga, Ballston Spa:(43.0009° N, 73.849° W):Jones, Matilda (1822–1914)" \f "Place" } on 24th December 1914, at the age of 92.^[43] Matilda was buried in Ballston Spa{ XE "USA, New York, Saratoga, Ballston Spa:(43.0009° N, 73.849° W):Jones, Matilda (1822–1914)" \f "Place" }.^[43]
- m III. **Rufus Jones**{ XE "Jones:Rufus (1823–1874)" \f "Name" \b } was born in 1823.^[43] He died on 3rd December 1874, at the age of 51.^[43] Rufus was buried in Ballston Spa, Saratoga{ XE "USA, New York, Saratoga, Ballston Spa:(43.0009° N, 73.849° W):Jones, Rufus (1823–1874)" \f "Place" }.^[43]
- f IV. **Angeline Sears Jones**{ XE "Jones:Angeline Sears (1827–1898)" \f "Name" \b } was born in Schoharie{ XE "USA, New York, Schoharie:(42.591° N, 74.4394° W):Jones, Angeline Sears (1827–1898)" \f "Place" } on 26th August 1827.^[43] She died in New Haven, New Haven, Connecticut,{ XE "USA, Connecticut, New Haven, New Haven:(41.3082° N, 72.9281° W):Jones, Angeline Sears (1827–1898)" \f "Place" } on 7th September 1898, at the age of 71.^[43] Angeline Sears was buried in New Haven{ XE "USA, Connecticut, New Haven, New Haven:(41.3082° N, 72.9281° W):Jones, Angeline Sears (1827–1898)" \f "Place" }.^[43]
- m V. **Wesley Jones**{ XE "Jones:Wesley (1832–1840)" \f "Name" \b } was born in Saratoga{ XE "USA, New York, Saratoga:(43.1059° N, 73.8677° W):Jones, Wesley (1832–1840)" \f "Place" } on 24th November 1832.^[43] He died in Saratoga{ XE "USA, New York, Saratoga:(43.1059° N, 73.8677° W):Jones, Wesley (1832–1840)" \f "Place" } on 18th November 1840, at the age of 7.^[43] Wesley was buried in Ballston Spa, Saratoga{ XE "USA, New York, Saratoga, Ballston Spa:(43.0009° N, 73.849° W):Jones, Wesley (1832–1840)" \f "Place" }.^[43]
- f VI. **Catherine L Jones**{ XE "Jones:Catherine L (1834–1901)" \f "Name" \b } was born in Schoharie{ XE "USA, New York, Schoharie:(42.591° N, 74.4394° W):Jones, Catherine L (1834–1901)" \f "Place" } on 19th August 1834.^[43] She died in Amsterdam, Montgomery County,{ XE "USA, New York, Montgomery County, Amsterdam:(42.9387° N, 74.1882° W):Jones, Catherine L (1834–1901)" \f "Place" } on 17th November 1901, at the age of 67.^[43] Catherine L was buried in Amsterdam{ XE "USA, New York, Montgomery County, Amsterdam:(42.9387° N, 74.1882° W):Jones, Catherine L (1834–1901)" \f "Place" }.^[43]
- f VII. **Emeline Jones**{ XE "Jones:Emeline (1836–1839)" \f "Name" \b } was born in Saratoga{ XE "USA, New York, Saratoga:(43.1059° N, 73.8677° W):Jones, Emeline (1836–1839)" \f "Place" } on 20th August 1836.^[43] She died in Saratoga{ XE "USA, New York, Saratoga:(43.1059° N, 73.8677° W):Jones, Emeline (1836–1839)" \f "Place" } on 17th February 1839, at the age of 2.^[43] Emeline was buried in Ballston Spa, Saratoga{ XE "USA, New York, Saratoga, Ballston Spa:(43.0009° N, 73.849° W):Jones, Emeline (1836–1839)" \f "Place" }.^[43]
- f VIII. **Mary L Jones**{ XE "Jones:Mary L (1846–1846)" \f "Name" \b } was born in Saratoga{ XE "USA, New York, Saratoga:(43.1059° N, 73.8677° W):Jones, Mary L (1846–1846)" \f "Place" } on 15th February 1846.^[43] She died in Saratoga{ XE "USA, New York,

Saratoga:(43.1059° N, 73.8677° W):Jones, Mary L (1846–1846)" \f "Place" } on 2nd April 1846.^[43] Mary L was buried in Ballston Spa, Saratoga{ XE "USA, New York, Saratoga, Ballston Spa:(43.0009° N, 73.849° W):Jones, Mary L (1846–1846)" \f "Place" }.^[43]

- m IX. **Ebenezer Jones**{ XE "Jones:Ebenezer" \f "Name" \b }.
- m X. **Isaac Jones**{ XE "Jones:Isaac" \f "Name" \b }.
- f XI. **Juliet Jones**{ XE "Jones:Juliet" \f "Name" \b }.

Family of Ruhamah Sears and Noah Sherwood{ TC "Ruhamah Sears and Noah Sherwood" \I 3 \f C}

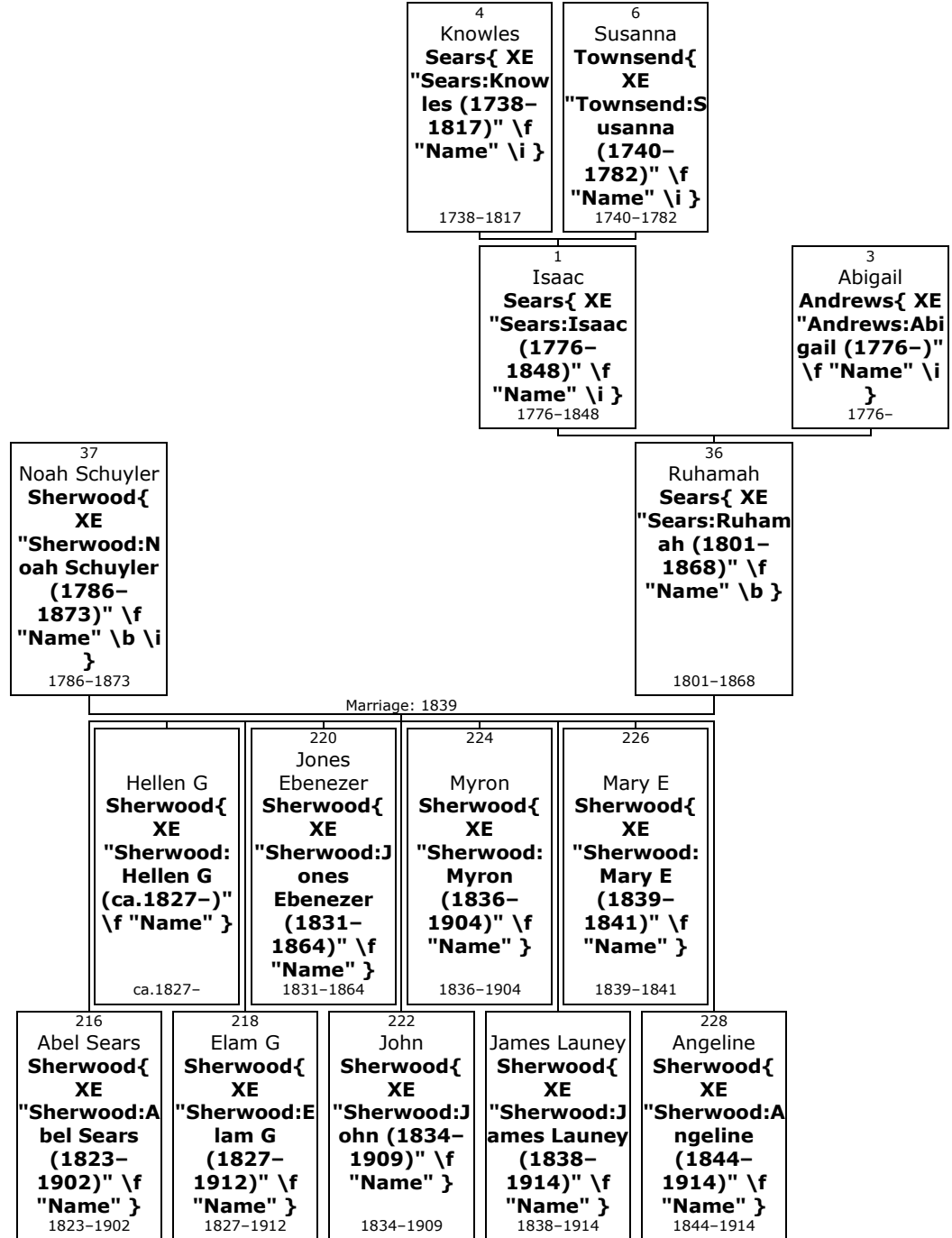

36. Ruhamah⁵ Sears{ XE "Sears:Ruhamah (1801–1868)" \f "Name" \b } (*Isaac⁴, Susanna³ Townsend*) was born on Sunday, 31st May 1801, in Clarkson, Monroe, New York, USA{ XE "USA, New York, Monroe,

Clarkson:(43.2331° N, 77.9278° W):Sears, Ruhamah (1801–1868)" \f "Place" }.^[44] She was the daughter of Isaac Sears{ XE "Sears:Isaac (1776–1848)" \f "Name" \i } (1) and Abigail Andrews{ XE "Andrews:Abigail (1776–)" \f "Name" \i } (3).

Ruhamah died in Niagara{ XE "USA, New York, Niagara:(43.3239° N, 78.7939° W):Sears, Ruhamah (1801–1868)" \f "Place" } on 19th June 1868, at the age of 67.^[44] She was buried in Somerset, Niagara County{ XE "USA, New York, Niagara County, Somerset:(43.3475° N, 78.5561° W):Sears, Ruhamah (1801–1868)" \f "Place" }.^[44]

No source for this child. Not in May

<https://www.wikitree.com/index.php?title=Sears-2127>

<https://www.findagrave.com/memorial/126020626>

Name: Ruamah Sherwood
 Birth Date: 31 May 1801
 Death Date: 19 Jun 1865
 Cemetery: West Somerset Cemetery
 Burial or Cremation Place: Somerset, Niagara County, New York, United States of America
 Has Bio?: N
 Spouse: Noah Schuyler Sherwood
 Children: James Launey Sherwood
 John Sherwood
 Abel Sears Sherwood
 Elon G Sherwood
 Angeline Hyde
 Myron Sherwood

More facts and events for Ruhamah Sears:

- Residence: 1850 Somerset, Niagara{ XE "USA, New York, Niagara, Somerset:(43.3475° N, 78.5561° W):Sears, Ruhamah (1801–1868)" \f "Place" }
- Residence: 1855 Somerset{ XE "USA, New York, Niagara, Somerset:(43.3475° N, 78.5561° W):Sears, Ruhamah (1801–1868)" \f "Place" }

37. Ruhamah married **Noah Schuyler Sherwood**{ XE "Sherwood:Noah Schuyler (1786–1873)" \f "Name" \b \i } in 1839.^[44] They had nine children: Abel (1823–1902), Hellen (ca.1827–), Elam (1827–1912), Jones (1831–1864), John (1834–1909), Myron (1836–1904), James (1838–1914), Mary (1839–1841) and Angeline (1844–1914).

Noah Schuyler was born in New Fairfield, Fairfield, Connecticut,{ XE "USA, Connecticut, Fairfield, New Fairfield:(41.4664° N, 73.4861° W):Sherwood, Noah Schuyler (1786–1873)" \f "Place" } on Thursday, 26th October 1786.^[44] He reached 86 years of age and died in Niagara{ XE "USA, New York, Niagara:(43.3239° N, 78.7939° W):Sherwood, Noah Schuyler (1786–1873)" \f "Place" } on 8th October 1873.^[44] Noah Schuyler was buried in Somerset, Niagara County{ XE "USA, New York, Niagara County, Somerset:(43.3475° N, 78.5561° W):Sherwood, Noah Schuyler (1786–1873)" \f "Place" }.^[44]

More facts and events for Noah Schuyler Sherwood:

- Residence: 1850 Somerset, Niagara{ XE "USA, New York, Niagara, Somerset:(43.3475° N, 78.5561° W):Sherwood, Noah Schuyler (1786–1873)" \f "Place" }
- Residence: 1850 Somerset{ XE "USA, New York, Niagara, Somerset:(43.3475° N, 78.5561° W):Sherwood, Noah Schuyler (1786–1873)" \f "Place" }
- Residence: 1850 Somerset{ XE "USA, New York, Niagara, Somerset:(43.3475° N, 78.5561° W):Sherwood, Noah Schuyler (1786–1873)" \f "Place" }
- Residence: 1855 Somerset{ XE "USA, New York, Niagara, Somerset:(43.3475° N, 78.5561° W):Sherwood, Noah Schuyler (1786–1873)" \f "Place" }
- Residence: 1855 Somerset{ XE "USA, New York, Niagara, Somerset:(43.3475° N, 78.5561° W):Sherwood, Noah Schuyler (1786–1873)" \f "Place" }

⁴⁴ Ancestry.com, U.S., Find A Grave Index, 1600s-Current (Provo, UT, USA, Ancestry.com Operations, Inc., 2012), Ancestry.com.

Residence: 1855 Somerset{ XE "USA, New York, Niagara, Somerset:(43.3475° N, 78.5561° W):Sherwood, Noah Schuyler (1786–1873)" \f "Place" }

Residence: Hartland{ XE "USA, New York, Niagara, Hartland:(43.24° N, 78.5764° W):Sherwood, Noah Schuyler (1786–1873)" \f "Place" }
came in 1835 to Somerset NY

Children of Ruhamah Sears and Noah Schuyler Sherwood:

- + 216 m I. **Abel Sears⁶ Sherwood**{ XE "Sherwood:Abel Sears (1823–1902)" \f "Name" } was born on 1st January 1823.^[44] He died in 1902 at the age of 79.^[44]
 - f II. **Hellen G Sherwood**{ XE "Sherwood:Hellen G (ca.1827–)" \f "Name" \b } was born about 1827.
- + 218 m III. **Elam G Sherwood**{ XE "Sherwood:Elam G (1827–1912)" \f "Name" } was born in Hartland{ XE "USA, New York, Niagara, Hartland:(43.24° N, 78.5764° W):Sherwood, Elam G (1827–1912)" \f "Place" } on 10th May 1827.^[44, 45] He was also known as **Elon**{ XE "Sherwood:Elon (Elam G. Sherwood) (1827–1912)" \f "Name" }.^[45]
 - Elam G died in Niagara{ XE "USA, New York, Niagara:(43.3239° N, 78.7939° W):Sherwood, Elam G (1827–1912)" \f "Place" } on 24th November 1912, at the age of 85.^[44, 45]
- + 220 m IV. **Jones Ebenezer Sherwood**{ XE "Sherwood:Jones Ebenezer (1831–1864)" \f "Name" } was born in Clarkson, Monroe,{ XE "USA, New York, Monroe, Clarkson:(43.2331° N, 77.9278° W):Sherwood, Jones Ebenezer (1831–1864)" \f "Place" } on 29th May 1831.^[44, 46, 47] He died in Fort Sumter, Andersonville, Sumter, Georgia,{ XE "USA, Georgia, Sumter, Andersonville, Fort Sumter: :Sherwood, Jones Ebenezer (1831–1864)" \f "Place" } on 4th August 1864, at the age of 33.^[44, 48, 49, 50, 51–52]
- + 222 m V. **John Sherwood**{ XE "Sherwood:John (1834–1909)" \f "Name" } was born in New York{ XE "USA, New York:(42.7531° N, 74.2224° W):Sherwood, John (1834–1909)" \f "Place" } on 27th October 1834.^[44] He died in 1909 at the age of 74.^[44]
- + 224 m VI. **Myron Sherwood**{ XE "Sherwood:Myron (1836–1904)" \f "Name" } was born in Somerset, Niagara, New York,{ XE "USA, New York, Niagara, Somerset:(43.3475° N, 78.5561° W):Sherwood, Myron (1836–1904)" \f "Place" } on 13th July 1836.^[44, 53, 54, 55, 56, 57, 58, 59, 60–61] He died in 1904 at the age of 67.^[44]

⁴⁵ FamilySearch.org, FamilySearch Family Tree, FamilySearch, "Family Tree," database, <i>FamilySearch</i> (http://familysearch.org : modified 08 July 2017, 15:03), entry for Elam G. Sherwood(PID https://familysearch.org/ark:/61903/4:1:KCN1-TPL); contributed by various users. PersonID KCN1-TPL. Elam G. Sherwood. https://familysearch.org/ark:/61903/4:1:KCN1-TPL.

⁴⁶ Ancestry.com, New York, State Census, 1865 (Provo, UT, USA, Ancestry.com Operations, Inc., 2014), Ancestry.com.

⁴⁷ Ancestry.com, New York, Registers of Officers and Enlisted Men Mustered into Federal Service, 1861-1865 (Provo, UT, USA, Ancestry.com Operations, Inc., 2014), Ancestry.com.

⁴⁸ Ancestry.com, Andersonville Prisoners of War (Provo, UT, USA, Ancestry.com Operations Inc, 1999), Ancestry.com.

⁴⁹ Ancestry.com, Web: Georgia, Find A Grave Index, 1728-2012 (Provo, UT, USA, Ancestry.com Operations, Inc., 2012), Ancestry.com.

⁵⁰ Ancestry.com, U.S., Burial Registers, Military Posts and National Cemeteries, 1862-1960 (Provo, UT, USA, Ancestry.com Operations, Inc., 2012), Ancestry.com.

⁵¹ Ancestry.com, U.S., Registers of Deaths of Volunteers, 1861-1865 (Provo, UT, USA, Ancestry.com Operations, Inc., 2012), Ancestry.com.

⁵² Ancestry.com, U.S. National Cemetery Interment Control Forms, 1928-1962 (Provo, UT, USA, Ancestry.com Operations, Inc., 2012), Ancestry.com.

⁵³ FamilySearch.org, FamilySearch Family Tree, FamilySearch, "Family Tree," database, <i>FamilySearch</i> (http://familysearch.org : modified 17 March 2018, 20:08), entry for Myron Sherwood(PID https://familysearch.org/ark:/61903/4:1:KZ7B-TZY); contributed by various users. PersonID KZ7B-TZY. Myron Sherwood. https://familysearch.org/ark:/61903/4:1:KZ7B-TZY.

⁵⁴ FamilySearch.org, FamilySearch Family Tree, FamilySearch, "United States Census, 1860", database with images, <i>FamilySearch</i> (https://familysearch.org/ark:/61903/1:1:MCWV-MLQ : 12 December 2017), Myron Sherwood in entry for John Collard, 1860. Myron Sherwood in household of John Collard, "United States Census, 1860". https://familysearch.org/ark:/61903/1:1:MCWV-MLQ.

- m VII. **James Launey Sherwood**{ XE "Sherwood:James Launey (1838–1914)" \f "Name" \b } was born in March 1838.^[44] He died in 1914 at the age of 75.^[44] James Launey was buried in Somerset, Niagara County{ XE "USA, New York, Niagara County, Somerset:(43.3475° N, 78.5561° W):Sherwood, James Launey (1838–1914)" \f "Place" }.^[44]
- + 226 f VIII. **Mary E Sherwood**{ XE "Sherwood:Mary E (1839–1841)" \f "Name" } was born on 1st December 1839. She died in 1841 at the age of 1.
- + 228 f IX. **Angeline Sherwood**{ XE "Sherwood:Angeline (1844–1914)" \f "Name" } was born in Somerset{ XE "USA, New York, Niagara, Somerset:(43.3475° N, 78.5561° W):Sherwood, Angeline (1844–1914)" \f "Place" } on 7th July 1844.^[44, 62, 63–64] She died in Genesee, Potter, Pennsylvania,{ XE "USA, Pennsylvania, Potter, Genesee:(41.9892° N, 77.8661° W):Sherwood, Angeline (1844–1914)" \f "Place" } on 22nd February 1914, at the age of 69.^[44, 62]

⁵⁵ FamilySearch.org, FamilySearch Family Tree, FamilySearch, "New York State Census, 1855," database with images, <i>FamilySearch</i> (https://familysearch.org/ark:/61903/1:1:K67T-SZJ : 13 March 2018), Myron Sherwood in household of Noah Sherwood, Somerset, Niagara, New York, United States; citing p. , line #31, fa. Myron Sherwood in household of Noah Sherwood, "New York State Census, 1855". https://familysearch.org/ark:/61903/1:1:K67T-SZJ.

⁵⁶ FamilySearch.org, FamilySearch Family Tree, FamilySearch, "United States Census, 1870," database with images, <i>FamilySearch</i> (https://familysearch.org/ark:/61903/1:1:M8VS-RYB : 12 April 2016), Myron Sherwood, New York, United States; citing p. 62, family 549, NARA microfilm publication M593 (Washington D.C. Myron Sherwood, "United States Census, 1870". https://familysearch.org/ark:/61903/1:1:M8VS-RYB.

⁵⁷ FamilySearch.org, FamilySearch Family Tree, FamilySearch, "New York State Census, 1875," database with images, <i>FamilySearch</i> (https://familysearch.org/ark:/61903/1:1:VTZG-TC3 : 11 March 2018), Myron Sherwood, Hartland, Niagara, New York, United States; citing p. 23, line 29, State Library, Albany; FHL micr. Myron Sherwood, "New York State Census, 1875". https://familysearch.org/ark:/61903/1:1:VTZG-TC3.

⁵⁸ FamilySearch.org, FamilySearch Family Tree, FamilySearch, "New York State Census, 1865," database with images, <i>FamilySearch</i> (https://familysearch.org/ark:/61903/1:1:QVNJ-GYDJ : accessed 19 December 2018), Myron Sherwood, District 01, Newfane, Niagara, New York, United States; citing source p. 33, line 36., Myron Sherwood, "New York State Census, 1865". https://familysearch.org/ark:/61903/1:1:QVNJ-GYDJ.

⁵⁹ FamilySearch.org, FamilySearch Family Tree, FamilySearch, "United States Census, 1900," database with images, <i>FamilySearch</i> (https://familysearch.org/ark:/61903/1:1:MS26-FXR : accessed 19 December 2018), Myron Sherwood, Hartland Township, Election District 1 Middleport village (part), Niagara, New York, Un. Myron Sherwood, "United States Census, 1900". https://familysearch.org/ark:/61903/1:1:MS26-FXR.

⁶⁰ FamilySearch.org, FamilySearch Family Tree, FamilySearch, "United States Census, 1880," database with images, <i>FamilySearch</i> (https://familysearch.org/ark:/61903/1:1:MZXZ-73P : 8 September 2017), Miron Sherwood, Hartland, Niagara, New York, United States; citing enumeration district ED 178, sheet 56D, NARA. Miron Sherwood, "United States Census, 1880". https://familysearch.org/ark:/61903/1:1:MZXZ-73P.

⁶¹ FamilySearch.org, FamilySearch Family Tree, FamilySearch, "United States Census, 1850," database with images, <i>FamilySearch</i> (https://familysearch.org/ark:/61903/1:1:MCBK-ZNS : 12 April 2016), Myron Sherwood in household of Noah Sherwood, Somerset, Niagara, New York, United States; citing family 166, NARA m. Myron Sherwood in household of Noah Sherwood, "United States Census, 1850". https://familysearch.org/ark:/61903/1:1:MCBK-ZNS.

⁶² FamilySearch.org, FamilySearch Family Tree, FamilySearch, "Family Tree," database, <i>FamilySearch</i> (http://familysearch.org : modified 12 September 2017, 14:43), entry for Angeline Sherwood(PID https://familysearch.org/ark:/61903/4:1:K8BR-8YS); contributed by various users. PersonID K8BR-8YS. Angeline Sherwood. https://familysearch.org/ark:/61903/4:1:K8BR-8YS.

⁶³ FamilySearch.org, FamilySearch Family Tree, FamilySearch, "New York State Census, 1855," database with images, <i>FamilySearch</i> (https://familysearch.org/ark:/61903/1:1:K67T-SZK : 13 March 2018), Angelina Sherwood in household of Noah Sherwood, Somerset, Niagara, New York, United States; citing p. , line #33., Angelina Sherwood in household of Noah Sherwood, "New York State Census, 1855". https://familysearch.org/ark:/61903/1:1:K67T-SZK.

⁶⁴ FamilySearch.org, FamilySearch Family Tree, FamilySearch, "United States Census, 1850," database with images, <i>FamilySearch</i> (https://familysearch.org/ark:/61903/1:1:MCBK-ZNQ : 12 April 2016), Angelein Sherwood in household of Noah Sherwood, Somerset, Niagara, New York, United States; citing family 166, NAR. Angelein Sherwood in household of Noah Sherwood, "United States Census, 1850". https://familysearch.org/ark:/61903/1:1:MCBK-ZNQ.

Family of Haman Sears and Ann Moore{ TC "Haman Sears and Ann Moore" \I 3 \f C}

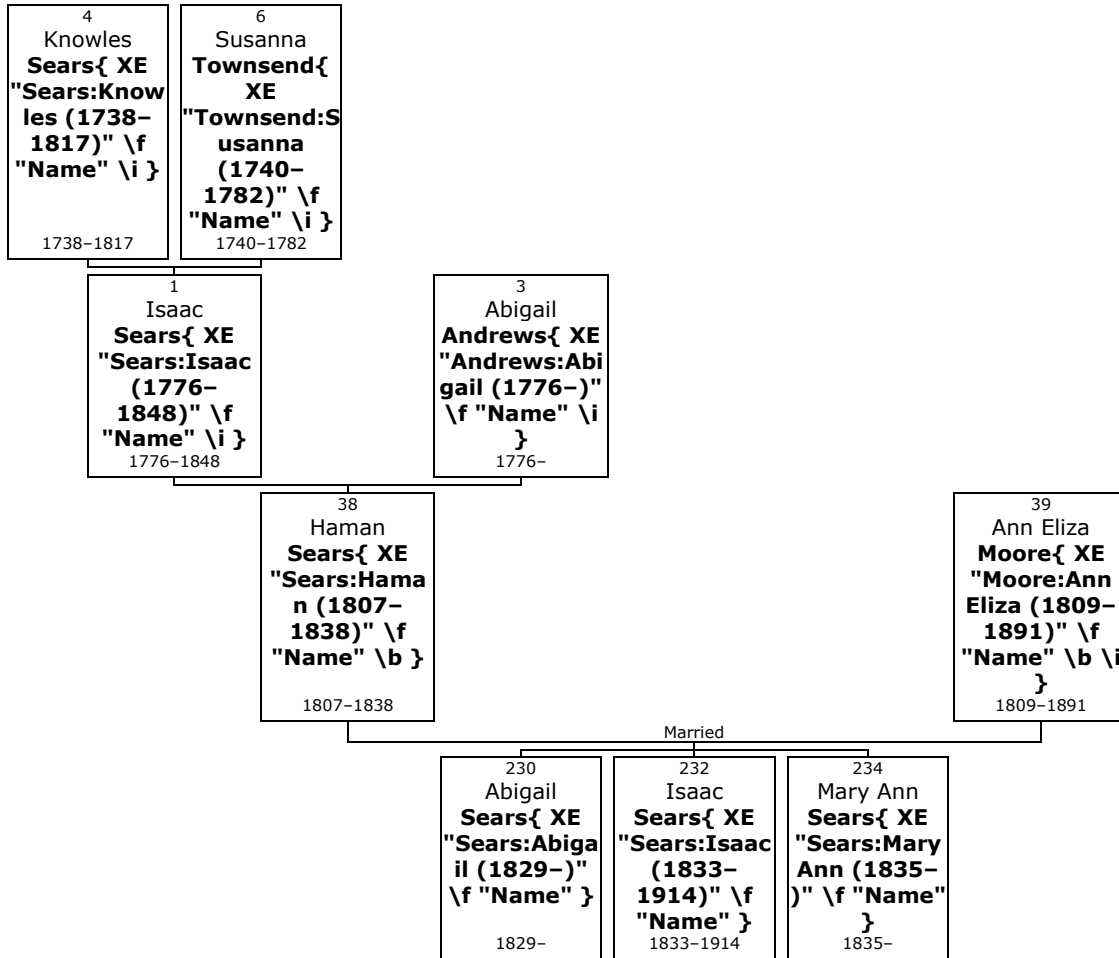

38. **Haman⁵ Sears**{ XE "Sears:Haman (1807-1838)" \f "Name" \b } (*Isaac⁴, Susanna³ Townsend*) was born on Saturday, 23rd May 1807, in Newfane, Niagara, New York, USA{ XE "USA, New York, Niagara, Newfane:(43.2867° N, 78.7103° W):Sears, Haman (1807-1838)" \f "Place" }. He was the son of Isaac Sears{ XE "Sears:Isaac (1776-1848)" \f "Name" \i } (1) and Abigail Andrews{ XE "Andrews:Abigail (1776-)" \f "Name" \i } (3).

Haman died in Olcott{ XE "USA, New York, Niagara, Olcott:(43.3378° N, 78.7148° W):Sears, Haman (1807-1838)" \f "Place" } on 21st February 1838, at the age of 30.

<https://www.wikitree.com/wiki/Sears-5712>

39. He married **Ann Eliza Moore**{ XE "Moore:Ann Eliza (1809-1891)" \f "Name" \b \i }. They had three children: Abigail (1829-), Isaac (1833-1914) and Mary (1835-).

Ann Eliza was born in Newfane{ XE "USA, New York, Niagara, Newfane:(43.2867° N, 78.7103° W):Moore, Ann Eliza (1809-1891)" \f "Place" } on Saturday, 8th April 1809. She reached 82 years of age and died on 1st November 1891.

Children of Haman Sears and Ann Eliza Moore:

- + 230 f I. **Abigail⁶ Sears**{ XE "Sears:Abigail (1829-)" \f "Name" } was born in Newfane{ XE "USA, New York, Niagara, Newfane:(43.2867° N, 78.7103° W):Sears, Abigail (1829-)" \f "Place" } on 25th September 1829.^[65]
- + 232 m II. **Isaac Sears**{ XE "Sears:Isaac (1833-1914)" \f "Name" } was born in Newfane{ XE "USA, New York, Niagara, Newfane:(43.2867° N, 78.7103° W):Sears, Isaac (1833-

⁶⁵ FamilySearch.org, FamilySearch Family Tree, FamilySearch, "Family Tree," database, <i>FamilySearch</i> (<http://familysearch.org> : modified 19 May 2016, 20:19), entry for Abigail Sears(PID <https://familysearch.org/ark:/61903/4:1:KCHW-QF8>); contributed by various users. PersonID KCHW-QF8. Abigail Sears. <https://familysearch.org/ark:/61903/4:1:KCHW-QF8>.

1914)" \f "Place" } on 4th September 1833.^[66, 67, 68, 69, 70-71] He died in 1914 at the age of 80.^[69]

+ 234 f III. **Mary Ann Sears**{ XE "Sears:Mary Ann (1835-)" \f "Name" } was born in perh, Newfane,{ XE "USA, New York, Niagara, Newfane, perh: :Sears, Mary Ann (1835-)" \f "Place" } in 1835.^[72, 73, 74, 75-76]

⁶⁶ Ancestry.com, 1910 United States Federal Census (Provo, UT, USA, Ancestry.com Operations Inc, 2006), Ancestry.com, Year: 1910; Census Place: Lockport Ward 4, Niagara, New York; Roll: T624_1049; Page: 7A; Enumeration District: 0084; FHL microfilm: 1375062.

⁶⁷ Ancestry.com, New York, State Census, 1875 (Provo, UT, USA, Ancestry.com Operations, Inc., 2013), Ancestry.com.

⁶⁸ Ancestry.com, 1900 United States Federal Census (Provo, UT, USA, Ancestry.com Operations Inc, 2004), Ancestry.com, Year: 1900; Census Place: Newfane, Niagara, New York; Roll: 1129; Page: 10A; Enumeration District: 0067; FHL microfilm: 1241129.

⁶⁹ Ancestry.com, U.S., Find A Grave Index, 1600s-Current (Provo, UT, USA, Ancestry.com Operations, Inc., 2012), Ancestry.com.

⁷⁰ Ancestry.com, New York, State Census, 1905 (Provo, UT, USA, Ancestry.com Operations, Inc., 2014), Ancestry.com, New York State Archives; Albany, New York; State Population Census Schedules, 1905; Election District: A.D. 02 E.D. 02; City: Newfane; County: Niagara; Page: 7.

⁷¹ Ancestry.com and The Church of Jesus Christ of Latter-day Saints, 1880 United States Federal Census (Provo, UT, USA, Ancestry.com Operations Inc, 2010), Ancestry.com, Year: 1880; Census Place: Newfane, Niagara, New York; Roll: 900; Family History Film: 1254900; Page: 148C; Enumeration District: 184; Image: 0661.

⁷² FamilySearch.org, FamilySearch Family Tree, FamilySearch, "Family Tree," database, <i>FamilySearch</i> (<http://familysearch.org> : modified 02 August 2018, 21:54), entry for Mary Ann Sears(PID <https://familysearch.org/ark:/61903/4:1:LVZ4-7LR>); contributed by various users. PersonID LVZ4-7LR. Mary Ann Sears. <https://familysearch.org/ark:/61903/4:1:LVZ4-7LR>.

⁷³ FamilySearch.org, FamilySearch Family Tree, FamilySearch, Source Citation Probate Records, [Niagara County, New York] 1820-1906 (Approx.); Author: New York. Surrogate's Court (Niagara County); Probate Place: Niagara, New York Source Information Ancestry.com. New York, Wills and Probate Records, 165. Mary Ann Sears in the New York, Wills and Probate Records, 1659-1999 for grandfather, Isaa Sears:.

⁷⁴ FamilySearch.org, FamilySearch Family Tree, FamilySearch, Source Citation Probate Records, [Niagara County, New York] 1820-1906 (Approx.); Author: New York. Surrogate's Court (Niagara County); Probate Place: Niagara, New York Source Information Ancestry.com. New York, Wills and Probate Records, 165. Mary Ann Sears in the New York, Wills and Probate Records, 1659-1999 for father, Haman Sears. https://www.ancestry.com/interactive/8800/005116436_00235?pid=2719508&backurl=http://search.ancestry.com/cgi-bin/sse.dll?indiv%3D1%26dbid%3D8800%26h%3D2719508%26ssrc%3Dpt%26tid%3D17384233%26pid%3D430112967946%26usePUB%3Dtrue&ssrc=pt&treeid=17384233&personid=430112967946&hintid=&usePUB=true&usePUBJs=true.

⁷⁵ FamilySearch.org, FamilySearch Family Tree, FamilySearch, Source Information Ancestry.com. New York, State Census, 1855 [database on-line]. Provo, UT, USA: Ancestry.com Operations, Inc., 2013. Original data: Census of the state of New York, for 1855. Microfilm. New York State Archives, Albany, New York. James & Mary Ann [Sears] Christie in the New York, State Census, 1855. https://www.ancestry.com/interactive/7181/005207173_00122/1653993779?backurl=https://www.ancestry.com/family-tree/person/tree/17384233/person/430112968108/facts.

⁷⁶ FamilySearch.org, FamilySearch Family Tree, FamilySearch, "United States Census, 1860", database with images, <i>FamilySearch</i> (<https://familysearch.org/ark:/61903/1:1:MCWV-9ZQ> : 12 December 2017), Mary A Christy in entry for Jams Chisty, 1860. Mary A Christy in household of Jams Chisty, "United States Census, 1860". <https://familysearch.org/ark:/61903/1:1:MCWV-9ZQ>.

Family of Heman Sears and Clarissa DuBois{ TC "Heman Sears and Clarissa DuBois" \I 3 \f C}

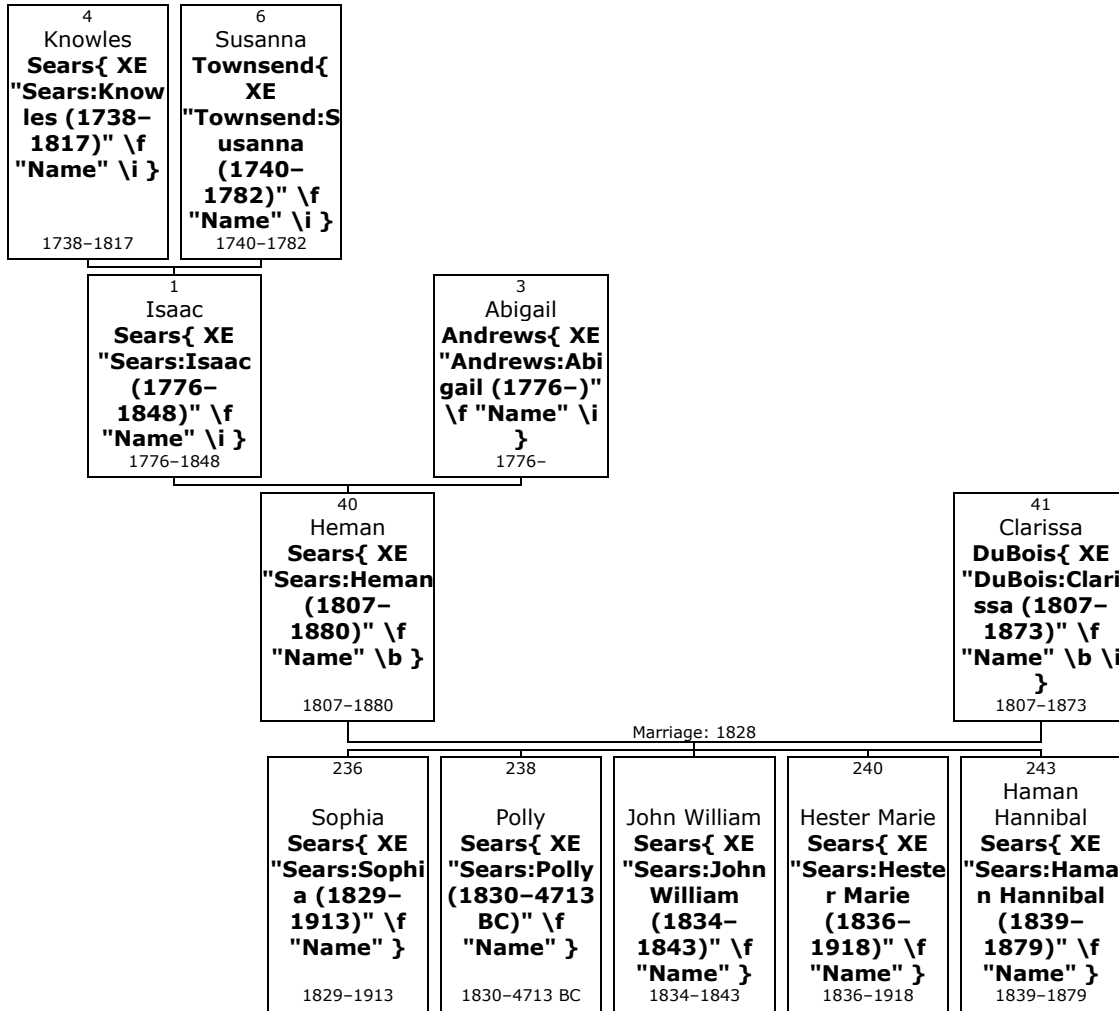

40. Heman⁵ Sears{ XE "Sears:Heman (1807-1880)" \f "Name" \b } (*Isaac⁴, Susanna³ Townsend*) was born on Saturday, 23rd May 1807, in perh, Danbury, Fairfield, Connecticut, USA{ XE "USA, Connecticut, Fairfield, Danbury, perh: :Sears, Heman (1807-1880)" \f "Place" }.^[77, 78] He was the son of Isaac Sears{ XE "Sears:Isaac (1776-1848)" \f "Name" \i } (1) and Abigail Andrews{ XE "Andrews:Abigail (1776-)" \f "Name" \i } (3).

Heman died in Newfane, Niagara, New York,{ XE "USA, New York, Niagara, Newfane:(43.2867° N, 78.7103° W):Sears, Heman (1807-1880)" \f "Place" } on 14th January 1880, at the age of 72.^[77, 78] He was buried in Olcott{ XE "USA, New York, Niagara, Olcott:(43.3378° N, 78.7148° W):Sears, Heman (1807-1880)" \f "Place" }.^[78]

gemini. Haman and Ann Eliza lived on the Drakes Settlement Road at the corner of the Fuller Road

41. Heman married **Clarissa DuBois**{ XE "DuBois:Clarissa (1807-1873)" \f "Name" \b \i } on Thursday, 24th January 1828.^[78] They had five children: Sophia (1829-1913), Polly (1830-4713 BC), John (1834-1843), Hester (1836-1918) and Haman (1839-1879).

Clarissa was born in perh, Newfane,{ XE "USA, New York, Niagara, Newfane, perh: :DuBois, Clarissa (1807-1873)" \f "Place" } in 1807.^[78] She reached 66 years of age and died in Olcott, Niagara County,{ XE "USA, New York, Niagara County, Olcott:(43.3378° N, 78.7148° W):DuBois, Clarissa (1807-1873)" \f

⁷⁷ Ancestry.com, New York, U.S. Census Mortality Schedules, 1850-1880 (Provo, UT, USA, Ancestry.com Operations, Inc, 2010), Ancestry.com, U.S. Census Mortality Schedules, New York, 1850-1880; New York State Education Department, Office of Cultural Education; Albany, New York; Year: 1880; Roll: M13; Line Number: 5. [Source citation includes one media item]

⁷⁸ Ancestry.com, U.S., Find A Grave Index, 1600s-Current (Provo, UT, USA, Ancestry.com Operations, Inc., 2012), Ancestry.com.

"Place" } on 25th June 1873.^[78] Clarissa was buried in Olcott, Niagara{ XE "USA, New York, Niagara, Olcott:(43.3378° N, 78.7148° W):DuBois, Clarissa (1807–1873)" \f "Place" }.^[78]

Children of Heman Sears and Clarissa DuBois:

- + 236 f I. **Sophia⁶ Sears**{ XE "Sears:Sophia (1829–1913)" \f "Name" } was born in perh, Newfane,{ XE "USA, New York, Niagara, Newfane, perh: :Sears, Sophia (1829–1913)" \f "Place" } on 28th January 1829.^[78, 79] She died in Newfane{ XE "USA, New York, Niagara, Newfane:(43.2867° N, 78.7103° W):Sears, Sophia (1829–1913)" \f "Place" } on 16th March 1913, at the age of 84.^[78]
- + 238 f II. **Polly Sears**{ XE "Sears:Polly (1830–4713 BC)" \f "Name" } was born in perh{ XE "USA, New York, Niagara, Newfane, perh: :Sears, Polly (1830–4713 BC)" \f "Place" } on 31st December 1830. She died on 15th April 4713 B.C., at the age of -6544.
- m III. **John William Sears**{ XE "Sears:John William (1834–1843)" \f "Name" \b } was born in perh{ XE "USA, New York, Niagara, Newfane, perh: :Sears, John William (1834–1843)" \f "Place" } on 18th February 1834. He died on 13th June 1843, at the age of 9.
- + 240 f IV. **Hester Marie Sears**{ XE "Sears:Hester Marie (1836–1918)" \f "Name" } was born in perh{ XE "USA, New York, Niagara, Newfane, perh: :Sears, Hester Marie (1836–1918)" \f "Place" } on 1st March 1836.^[78] She died in Wilson, Niagara County,{ XE "USA, New York, Niagara County, Wilson:(43.3098° N, 78.8262° W):Sears, Hester Marie (1836–1918)" \f "Place" } on 25th February 1918, at the age of 81.^[78]
- + 243 m V. **Haman Hannibal Sears**{ XE "Sears:Haman Hannibal (1839–1879)" \f "Name" } was born in Newfane{ XE "USA, New York, Niagara, Newfane:(43.2867° N, 78.7103° W):Sears, Haman Hannibal (1839–1879)" \f "Place" } on 18th July 1839.^[78] He died on 27th December 1879, at the age of 40.^[78]

⁷⁹ Ancestry.com, New York, State Census, 1865 (Provo, UT, USA, Ancestry.com Operations, Inc., 2014), Ancestry.com, Record for Oscar H Smith. <http://search.ancestry.com/cgi-bin/sse.dll?db=7218&h=1558657&indiv=try>.

Related 2 Steps Removed{ TC "Related 2 Steps Removed" \f C}

Grandparents{ TC "Grandparents" \I 2 \f C}

Family of James Sears and Desire Tobey{ TC "James Sears and Desire Tobey" \I 3 \f C}

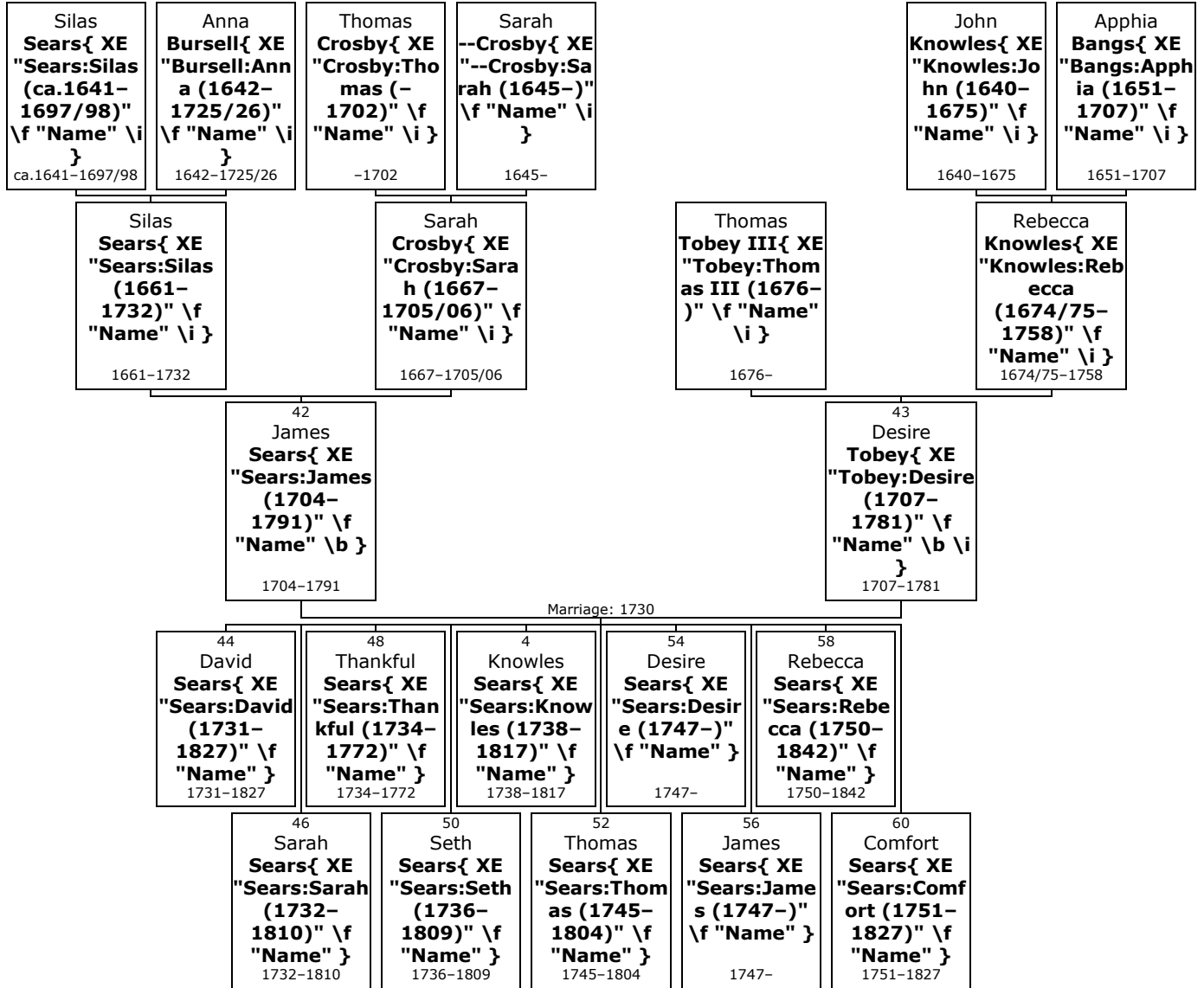

42. **James² Sears**{ XE "Sears:James (1704-1791)" \f "Name" \b } was born on 30th March 1704, in Yarmouth, Barnstable, Massachusetts, USA{ XE "USA, Massachusetts, Barnstable, Yarmouth:(41.7057° N, 70.2286° W):Sears, James (1704-1791)" \f "Place" }.^[80, 81] He was the son of Silas Sears{ XE "Sears:Silas (1661-1732)" \f "Name" \i } and Sarah Crosby{ XE "Crosby:Sarah (1667-1705/06)" \f "Name" \i }. James died in Ridgefield, Fairfield, Connecticut,{ XE "USA, Connecticut, Fairfield, Ridgefield:(41.2815° N, 73.4982° W):Sears, James (1704-1791)" \f "Place" } on 17th March 1791, at the age of 86.^[80, 81]

⁸⁰ Ancestry.com, Global, Find A Grave Index for Non-Burials, Burials at Sea, and other Select Burial Locations, 1300s-Current (Provo, UT, USA, Ancestry.com Operations, Inc., 2012), Ancestry.com, Find A Grave.

⁸¹ Ancestry.com, U.S., Sons of the American Revolution Membership Applications, 1889-1970 (Provo, UT, USA, Ancestry.com Operations, Inc., 2011), Ancestry.com, Volume: 143; SAR Membership Number: 28472. [Source citation includes one media item]

!Yarmouth VR p.40[back] m. by Tom Smith, Cler; [p.69] James Sears and Desiar Toby pub. Mar 14 1729/30

!

!Yarmouth VR [p.111] David Sears son of James and Desiar Sears he was born on the 25th day of August 1731 Sarah 21 Nov 1732 Thankfull 26 Nov 1734 Seth 31 Oct 1736 (Aug was crossed out and October interlined in same hand)

!

!S P May p.99, No 73, Oscar Weed, who lives in the old Sears homestead at Mill Plains, CT., has a deed dated July 10, 1739, from Robt. Hebard, Jr., and Ruth, his wife, of the town and county of Windham, CT, to James Sears, late of Yarmouth, county Barnstable, Province of Mass. Bay, of a tract of land in Windham, near the Shautucket river, containing 52 acres, the consideration being L 275. How long James Sears remained in Windham, if he lived there at all, is not known, but he is supposed to have removed to Mill Plains, then a part of Ridgefield, about 1740-45, although his name does not appear in "listable estates" of Ridgefield for 1746. James Sears was chosen pathmaster, Kent, CT (which is near by,) Apr. 7, 1747, and in 1756, of the Old Gilead Church in Carmel. He was one of the organizers of the Congregational Church in Ridgebury, (the northern society of Ridgefield) in 1769. After the death of his wife, Desire, he lived with his son Comfort, and tradition tells of his orderly habits and rigid religious observances. When he first settled in Ridgefield wild turkeys and other game abounded. It is related that one Sabbath morning a flock of wild turkeys alighted in his cornfield. Taking his gun he started to shoot them, but remembering that it was the Lord's Day, he returned, remarking, "you did not get to me that time, Mr. Devil."

!Esther A Savage-The CT Nutmegger, Dec 1992, p. 363

!James Sears (May p.64-65) ... Pelletreau (p.756) says the Sears family came to Putnam co (Then Dutchess co, NY) in 1743. James Sears lived on a farm adjacent to that of Eleazer Hamblin (No.135 RIN [13969]) in 1762, as shown by records of a survey of Lot 6 in that year. (Pelletreau, p.269). Near by, in the town of Southeast, "The most numerous families in former times were the CROSBYS"(Pelletreau, p. 429), descended from three brothers who came from Harwich, MA. David (No. 582 RIN [3725]) and Joshua Sears (No.256 RIN [4061]?) came in 1749. Thomas Sears (No.587 RIN [3730]) settled on a farm south of Carmel in 1753. These three were descended from the Rev Thomas Crosby baptized ... James Sears, his brother-in-law, arrived to settle near the HAMBLINS in 1743.

43. James married **Desire Tobey**{ XE "Tobey:Desire (1707-1781)" \f "Name" \b \i } on 28th May 1730, in Yarmouth, Barnstable, Massachusetts{ XE "USA, Massachusetts, Barnstable, Yarmouth:(41.7057° N, 70.2286° W):Sears, James (1704-1791)" \f "Place" }. They had ten children: David (1731-1827), Sarah (1732-1810), Thankful (1734-1772), Seth (1736-1809), Knowles (1738-1817), Thomas (1745-1804), Desire (1747-), James (1747-), Rebecca (1750-1842) and Comfort (1751-1827).

Desire was born in Eastham{ XE "USA, Massachusetts, Barnstable, Eastham:(41.8301° N, 69.9739° W):Tobey, Desire (1707-1781)" \f "Place" } in 1707. She was the daughter of Thomas Tobey III{ XE "Tobey:Thomas III (1676-)" \f "Name" \i } and Rebecca Knowles{ XE "Knowles:Rebecca (1674/75-1758)" \f "Name" \i }.

Desire reached 74 years of age and died in perh, Ridgefield, Fairfield, Connecticut,{ XE "USA, Connecticut, Fairfield, Ridgefield, perh: :Tobey, Desire (1707-1781)" \f "Place" } on 28th July 1781.

!NEHGS Register vol 79 pg 295 d. ae about 74, Ten children, including Seth, Knowles, and Rebecca Cf. Sears Genealogy, 1890, p. 98

Children of James Sears and Desire Tobey:

- + 44 m I. **David³ Sears**{ XE "Sears:David (1731-1827)" \f "Name" } was born in Yarmouth{ XE "USA, Massachusetts, Barnstable, Yarmouth:(41.7057° N, 70.2286° W):Sears, David (1731-1827)" \f "Place" } on 25th August 1731.^[82, 83, 84, 85-86] He died in Lenox,

⁸² Ancestry.com, U.S., Find A Grave Index, 1600s-Current (Provo, UT, USA, Ancestry.com Operations, Inc., 2012), Ancestry.com.

⁸³ Edmund West, comp., Family Data Collection - Births (Provo, UT, USA, Ancestry.com Operations Inc, 2001), Ancestry.com.

⁸⁴ Edmund West, comp., Family Data Collection - Individual Records (Provo, UT, USA, Ancestry.com Operations Inc, 2000), Ancestry.com, Birth year: 1731; Birth city: Yarmouth; Birth state: MA.

⁸⁵ Godfrey Memorial Library, comp., American Genealogical-Biographical Index (AGBI) (Provo, UT, USA, Ancestry.com Operations Inc, 1999), Ancestry.com.

⁸⁶ Ancestry.com, Massachusetts, Town and Vital Records, 1620-1988 (Provo, UT, USA, Ancestry.com Operations, Inc., 2011), Ancestry.com.

- Berkshire, { XE "USA, Massachusetts, Berkshire, Lenox:(42.3565° N, 73.2849° W):Sears, David (1731-1827)" \f "Place" } on 12th July 1827, at the age of 95.^[82, 84]
- + 46 f II. **Sarah Sears**{ XE "Sears:Sarah (1732-1810)" \f "Name" } was born in Yarmouth{ XE "USA, Massachusetts, Barnstable, Yarmouth:(41.7057° N, 70.2286° W):Sears, Sarah (1732-1810)" \f "Place" } on 21st November 1732. She died in 1810 at the age of 77.
- + 48 f III. **Thankful Sears**{ XE "Sears:Thankful (1734-1772)" \f "Name" } was born in Yarmouth{ XE "USA, Massachusetts, Barnstable, Yarmouth:(41.7057° N, 70.2286° W):Sears, Thankful (1734-1772)" \f "Place" } on 26th November 1734. She died in Milltown, New York, { XE "USA, New York, Milltown: :Sears, Thankful (1734-1772)" \f "Place" } on 27th July 1772, at the age of 37.
- + 50 m IV. **Seth Sears**{ XE "Sears:Seth (1736-1809)" \f "Name" } was born in Yarmouth{ XE "USA, Massachusetts, Barnstable, Yarmouth:(41.7057° N, 70.2286° W):Sears, Seth (1736-1809)" \f "Place" } on 31st October 1736.^[86] He died in Milltown, New York, { XE "USA, New York, Milltown: :Sears, Seth (1736-1809)" \f "Place" } on 2nd August 1809, at the age of 72.^[82, 87]
- + 4 m V. **Knowles Sears**{ XE "Sears:Knowles (1738-1817)" \f "Name" } was born in Ridgefield, Fairfield, Connecticut, { XE "USA, Connecticut, Fairfield, Ridgefield:(41.2815° N, 73.4982° W):Sears, Knowles (1738-1817)" \f "Place" } in 1738.^[82, 83, 85, 88, 89-90] He died in Ridgefield{ XE "USA, Connecticut, Fairfield, Ridgefield:(41.2815° N, 73.4982° W):Sears, Knowles (1738-1817)" \f "Place" } on 17th June 1817, at the age of 79.^[82, 88, 91-92]
- + 52 m VI. **Thomas Sears**{ XE "Sears:Thomas (1745-1804)" \f "Name" } was born in New York{ XE "USA, New York:(42.7531° N, 74.2224° W):Sears, Thomas (1745-1804)" \f "Place" } on 30th April 1745.^[93, 94-95] He died in Southeast, Putnam, New York, { XE "USA, New York, Putnam, Southeast:(41.4054° N, 73.6001° W):Sears, Thomas (1745-1804)" \f "Place" } on 26th April 1804, at the age of 58.^[94, 95]
- + 54 f VII. **Desire Sears**{ XE "Sears:Desire (1747-)" \f "Name" } was born in perh, Yarmouth, Barnstable, Massachusetts, { XE "USA, Massachusetts, Barnstable, Yarmouth, perh: :Sears, Desire (1747-)" \f "Place" } in 1747.
- + 56 m VIII. **James Sears**{ XE "Sears:James (1747-)" \f "Name" } was born in perh{ XE "USA, Massachusetts, Barnstable, Yarmouth, perh: :Sears, James (1747-)" \f "Place" } in 1747. He died in Quebec, Canada{ XE "Canada, Quebec:(47.4278° N, 71.8805° W):Sears, James (1747-)" \f "Place" }.
- + 58 f IX. **Rebecca Sears**{ XE "Sears:Rebecca (1750-1842)" \f "Name" } was born in perh, Ridgefield, Fairfield, Connecticut, { XE "USA, Connecticut, Fairfield, Ridgefield, perh: :Sears, Rebecca (1750-1842)" \f "Place" } in 1750. She died on 20th March 1842, at the age of 92.
- + 60 m X. **Comfort Sears**{ XE "Sears:Comfort (1751-1827)" \f "Name" } was born in Ridgefield{ XE "USA, Connecticut, Fairfield, Ridgefield:(41.2815° N, 73.4982° W):Sears, Comfort (1751-1827)" \f "Place" } on 20th March 1751.^[85, 90] He died in Ridgefield{ XE "USA,

⁸⁷ Ancestry.com, Web: New York, Find A Grave Index, 1660-2012 (Provo, UT, USA, Ancestry.com Operations, Inc., 2012), Ancestry.com.

⁸⁸ Ancestry.com, U.S., Sons of the American Revolution Membership Applications, 1889-1970 (Provo, UT, USA, Ancestry.com Operations, Inc., 2011), Ancestry.com.

⁸⁹ Ancestry.com, Connecticut, Hale Cemetery Inscriptions and Newspaper Notices, 1629-1934 (Provo, UT, USA, Ancestry.com Operations, Inc., 2012), Ancestry.com.

⁹⁰ Ancestry.com, Connecticut, Deaths and Burials Index, 1650-1934 (Provo, UT, USA, Ancestry.com Operations, Inc., 2011), Ancestry.com.

⁹¹ Edmund West, comp., Family Data Collection - Deaths (Provo, UT, USA, Ancestry.com Operations Inc, 2001), Ancestry.com.

⁹² Ancestry.com, Connecticut, Church Record Abstracts, 1630-1920 (Provo, UT, USA, , 2013), Ancestry.com.

⁹³ Yates Publishing, U.S. and International Marriage Records, 1560-1900 (Provo, UT, USA, Ancestry.com Operations Inc, 2004), Ancestry.com, Source number: 3430.008; Source type: Pedigree chart; Number of Pages: 13.

⁹⁴ Ancestry.com, North America, Family Histories, 1500-2000 (Provo, UT, USA, Ancestry.com Operations, Inc., 2016), Ancestry.com, Book Title: Lineage Book of the Charter Members of the DAR Vol 085.

⁹⁵ Ancestry.com, U.S., Sons of the American Revolution Membership Applications, 1889-1970 (Provo, UT, USA, Ancestry.com Operations, Inc., 2011), Ancestry.com, Volume: 156.

Connecticut, Fairfield, Ridgefield:(41.2815° N, 73.4982° W):Sears, Comfort (1751-1827)" \f "Place" } on 24th December 1827, at the age of 76.^[90, 92]

Uncles/aunts{ TC "Uncles/aunts" \I 2 \f C}

Family of David Sears and Mary Paddock{ TC "David Sears and Mary Paddock" \I 3 \f C}

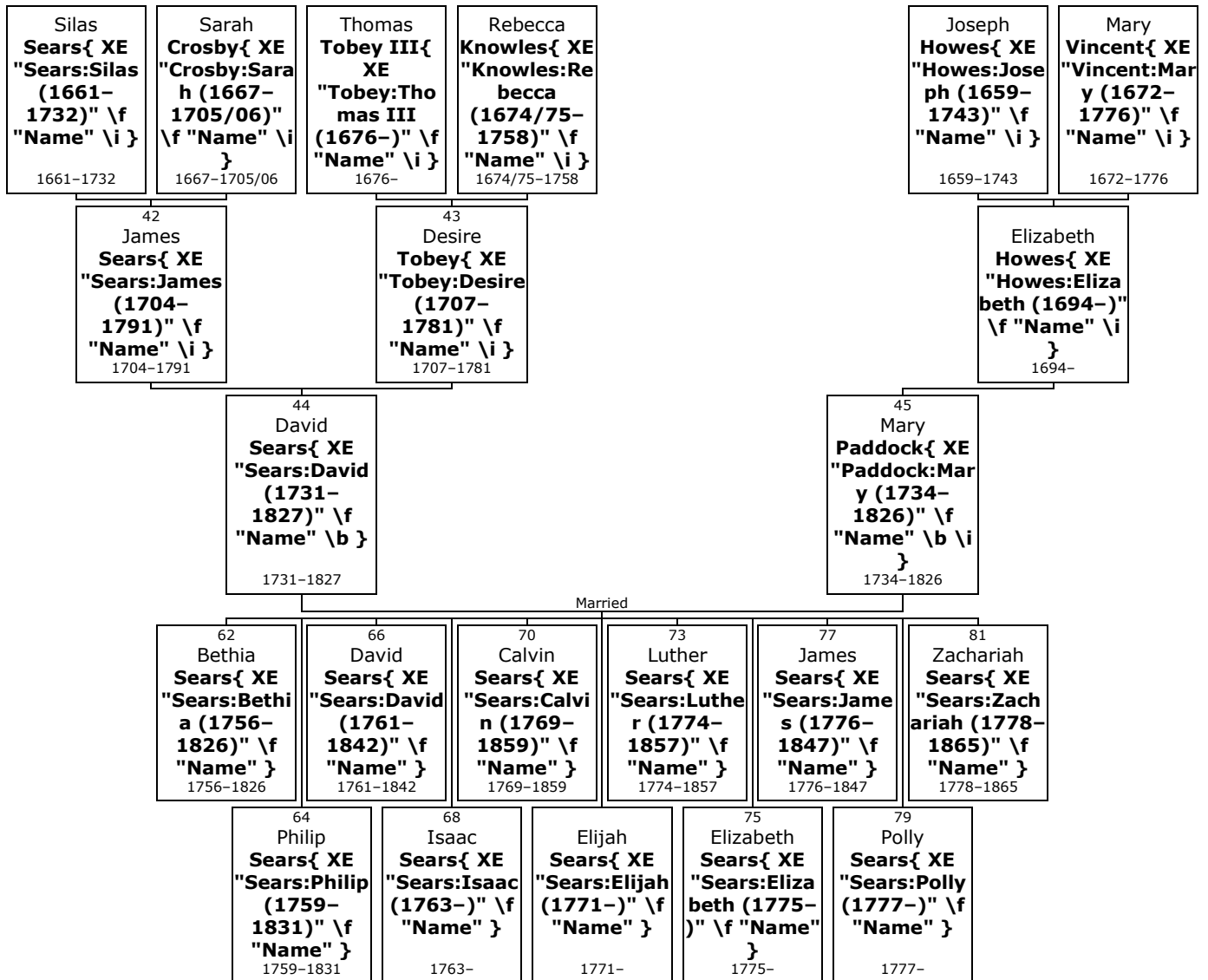

44. **David³ Sears**{ XE "Sears:David (1731-1827)" \f "Name" \b } (*James²*) was born on 25th August 1731, in Yarmouth, Barnstable, Massachusetts, USA{ XE "USA, Massachusetts, Barnstable, Yarmouth:(41.7057° N, 70.2286° W):Sears, David (1731-1827)" \f "Place" }.^[96, 97, 98, 99, 100, 101-102] He was the son of James

⁹⁶ Ancestry.com, U.S., Find A Grave Index, 1600s-Current (Provo, UT, USA, Ancestry.com Operations, Inc., 2012), Ancestry.com.

⁹⁷ Edmund West, comp., Family Data Collection - Births (Provo, UT, USA, Ancestry.com Operations Inc, 2001), Ancestry.com.

⁹⁸ Edmund West, comp., Family Data Collection - Individual Records (Provo, UT, USA, Ancestry.com Operations Inc, 2000), Ancestry.com, Birth year: 1731; Birth city: Yarmouth; Birth state: MA.

⁹⁹ Godfrey Memorial Library, comp., American Genealogical-Biographical Index (AGBI) (Provo, UT, USA, Ancestry.com Operations Inc, 1999), Ancestry.com.

¹⁰⁰ Ancestry.com, Massachusetts, Town and Vital Records, 1620-1988 (Provo, UT, USA, Ancestry.com Operations, Inc., 2011), Ancestry.com.
[Source citation includes one media item]

¹⁰¹ Ancestry.com, 1790 United States Federal Census (Provo, UT, USA, Ancestry.com Operations, Inc., 2010), Ancestry.com, Year: 1790; Census Place: Lenox, Berkshire, Massachusetts; Series: M637; Roll: 4; Page: 342; Image: 381; Family History Library Film: 0568144.
[Source citation includes one media item]

Sears{ XE "Sears:James (1704–1791)" \f "Name" \i } (42) and Desire Tobey{ XE "Tobey:Desire (1707–1781)" \f "Name" \i } (43).

David died in Lenox{ XE "USA, Massachusetts, Berkshire, Lenox:(42.3565° N, 73.2849° W):Sears, David (1731–1827)" \f "Place" } on 12th July 1827, at the age of 95.^[96, 98] He was buried in Lenox{ XE "USA, Massachusetts, Berkshire, Lenox:(42.3565° N, 73.2849° W):Sears, David (1731–1827)" \f "Place" }.^[96]

<https://www.wikitree.com/wiki/Sears-877>

!S.P. May p.174, No 293 David Sears rem. to North East, south precinct, Dutchess co.,NY (where "David Sears subscribed 10s. for Mr Kent's support," in 1754,) and thence previous to the Revolution to north part of Lenox, MA

! 3 Dec 1777, at a meeting of the Com. of Safety, it was "Voted John Whitlock, Ephraim Smith, David Sears, Philip Sears and Edward Martindale are dangerous to the United States of America."

! "Chose by ballot Major Caleb Hyde to procure evidence and support an action on behalf of said town against John Whitlock, David Sears, Philip Sears, Ephraim Smith and Edward Martindale, at a court of general sessions of the peace for the county of Berkshire, to be held at Gt Barrington, on Tuesday, the 9th day of Dec curent, for their being inimically disposed and dangerous to remain in the States of America."

! 21 Mar 1774, David was appointed Com. to lay out school money. 12 Mar 1776, David Sears on School Com.; 24 Mar 1788, chose David Sears, Tything-man. 2 Mar 1789, David Sears, Surveyor of Highways. 25 Apr 1794, he is returned as Baptist.

! A hole in the mountain at Lenox was called "the tory-hole," and was occupied by Gid. Smith of Stockbridge as a hiding-place, he being supplied with food by David Sears. I think some of his daughters were born before Luther. 1798 Lenox tax record- David Sears, 40 perches(not acres 160 sq perches to an acre) valuation \$350 Philip Sears 40 perches \$120 Calvin Sears 40 perches \$150

!Massachusetts, Town and Vital Records, 1620-1988 about David Sears Birth Date: 25 Aug 1731 Event Type: Birth Event City: Yarmouth Father Name: James Sears Mother Name: Desiar Sears <http://www.americanancestors.org/PageDetail.aspx?recordId=4296679>

!Deaths Reported in the Boston Recorder and Telegraph, 1827 and 1828 SEARS SEARS, David, 97, d. at Lenox. Ag. 10. 1827 Death Tracy Norstrom Steiner I'm wondering how accurate the May's Sears book actually is. Does anyone know if he listed sources anywhere? I have been unable to find supporting documentation to link David Sears, 1761-1842 (number 737 in the book) to his supposed father David Sears, 1731-1827 (number 294 in the book). My only source is the May's book. Is anyone else working on this line? Thanks

! Find a Grave Birth: Nov. 25, 1731 Lenox Berkshire County Massachusetts, USA Death: Jun. 12, 1827 Lenox Berkshire County Massachusetts, USA "Blessed and holy is he that ..." Son of James Sears and Desire Tobey of Yarmouth, Mass.; husband of Mary Paddock. They had 11 children: Philip, David, Isaac, Luther, James, Zachariah, Calvin, Elijah, Bethia, Elizabeth, and Polly. Family links: Spouse: Mary Paddock Sears (1734 - 1826) Children: Philip Sears (1759 - 1831)* *Calculated relationship Burial: New Lenox Cemetery Lenox Berkshire County Massachusetts, USA Plot: Row 4, Grave 174 Created by: waldonia Record added: Jan 25, 2010 Find A Grave Memorial# 47134892

!Massachusetts, Town and Vital Records, 1620-1988 Name: David Sears Birth Date: 25 Aug 1731 Event Type: Birth Event City: Yarmouth Father Name: James Sears Mother Name: Desiar Sears Name: David Seers [David Sears] Home in 1790 (City, County, State): Lenox, Berkshire, Massachusetts Free White Persons - Males - Under 16: 3 Free White Persons - Males - 16 and over: 3 Free White Persons - Females: 2 Number of Household Members: 8 1800 United States Federal Census about David Sears Name: David Sears Home in 1800 (City, County, State): Lenox, Berkshire, Massachusetts Free White Persons - Males -10 thru 15: 1 Free White Persons - Males - 16 thru 25: 1 Free White Persons - Males - 45 and over: 1 Free White Persons - Females - 45 and over: 1 Number of Household Members Under 16: 1 Number of Household Members Over 25: 2 Number of Household Members: 4

More facts and events for David Sears:

Residence: 1790 Lenox{ XE "USA, Massachusetts, Berkshire, Lenox:(42.3565° N, 73.2849° W):Sears, David (1731–1827)" \f "Place" }^[101]

¹⁰² Ancestry.com, 1800 United States Federal Census (Provo, UT, USA, Ancestry.com Operations Inc, 2010), Ancestry.com, Year: 1800; Census Place: Lenox, Berkshire, Massachusetts; Series: M32; Roll: 13; Page: 211; Image: 213; Family History Library Film: 205611.
[Source citation includes one media item]

Residence: 1800 Lenox{ XE "USA, Massachusetts, Berkshire, Lenox:(42.3565° N, 73.2849° W):Sears, David (1731–1827)" \f "Place" }^[102]

45. He married **Mary Paddock**{ XE "Paddock:Mary (1734–1826)" \f "Name" \b \i }.^[96] They had eleven children: Bethia (1756–1826), Philip (1759–1831), David (1761–1842), Isaac (1763–), Calvin (1769–1859), Elijah (1771–), Luther (1774–1857), Elizabeth (1775–), James (1776–1847), Polly (1777–) and Zachariah (1778–1865).

Mary was born at perhaps in Lenox{ XE "USA, Massachusetts, Berkshire, Lenox:(42.3565° N, 73.2849° W):Paddock, Mary (1734–1826)" \f "Place" } in 1734.^[96] She was the daughter of Elizabeth Howes{ XE "Howes:Elizabeth (1694–)" \f "Name" \i }.

Mary reached 92 years of age and died in Lenox{ XE "USA, Massachusetts, Berkshire, Lenox:(42.3565° N, 73.2849° W):Paddock, Mary (1734–1826)" \f "Place" } on 19th July 1826.^[96] She was buried in Lenox{ XE "USA, Massachusetts, Berkshire, Lenox:(42.3565° N, 73.2849° W):Paddock, Mary (1734–1826)" \f "Place" }.^[96]

From: Sara Murphy [mailto:sjm2@rmi.net] Sent: Tuesday, February 20, 2001 8:23 PM To: SEARS-L@rootsweb.com Subject: [[SEARS-L]] Rollcall I am looking for more information on David Sears [3725][James, Silas, Silas, Richard] b. 1731 in Yarmouth, MA, died 1827 in Lenox, MA] and his wife !Mary Paddock [probably the daughter of Zachariah [Zachariah, Zachariah and Deborah Sears, Richard] b. 1734 in Yarmouth and died in Lenox in 1826. Their daughter Elizabeth married Robert McKnight in 1791 and they lived in Livingston Co., NY most of their married lives. (This is contrary to Mays' history of that family but is proven by McKnight's pension records.) Their son Calvin Sears McKnight is my husband's gggrandfather. I'd like to find out more about whether Mary was also a Sears descendent. Birth: 1734 Massachusetts, USA Death: Jul. 19, 1826 Lenox Berkshire County Massachusetts, USA Daughter of Zachariah Paddock and Elizabeth Howes; wife of David Sears (see David Sears memorial for list of their 11 children). Family links: Spouse: David Sears (1731 - 1827)* Children: Philip Sears (1759 - 1831)* *Calculated relationship Burial: New Lenox Cemetery Lenox Berkshire County Massachusetts, USA Plot: Row 4 Edit Virtual Cemetery info [?] Created by: waldonia Record added: Jan 25, 2010 Find A Grave Memorial# 47134993

Children of David Sears and Mary Paddock:

- + 62 f I. **Bethia⁴ Sears**{ XE "Sears: Bethia (1756–1826)" \f "Name" } was born in Lenox{ XE "USA, Massachusetts, Berkshire, Lenox:(42.3565° N, 73.2849° W):Sears, Bethia (1756–1826)" \f "Place" } in 1756. She died in 1826 at the age of 70.
- + 64 m II. **Philip Sears**{ XE "Sears: Philip (1759–1831)" \f "Name" } was born in North East, Dutchess, New York,{ XE "USA, New York, Dutchess, North East:(41.9482° N, 73.5462° W):Sears, Philip (1759–1831)" \f "Place" } in 1759.^[96] He died in Lenox, Berkshire, Massachusetts,{ XE "USA, Massachusetts, Berkshire, Lenox:(42.3565° N, 73.2849° W):Sears, Philip (1759–1831)" \f "Place" } on 17th July 1831, at the age of 72.^[96]
- + 66 m III. **David Sears**{ XE "Sears: David (1761–1842)" \f "Name" } was born in perh{ XE "USA, New York, perh: :Sears, David (1761–1842)" \f "Place" } in 1761.^[96] He died in Milton, Saratoga,{ XE "USA, New York, Saratoga, Milton:(43.0337° N, 73.8526° W):Sears, David (1761–1842)" \f "Place" } on 19th August 1842, at the age of 81.^[96]
- + 68 m IV. **Isaac Sears**{ XE "Sears: Isaac (1763–)" \f "Name" } was born in perh, North East, Dutchess,{ XE "USA, New York, Dutchess, North East, perh: :Sears, Isaac (1763–)" \f "Place" } in 1763.
- + 70 m V. **Calvin Sears**{ XE "Sears: Calvin (1769–1859)" \f "Name" } was born in Lenox, Berkshire, Massachusetts,{ XE "USA, Massachusetts, Berkshire, Lenox:(42.3565° N, 73.2849° W):Sears, Calvin (1769–1859)" \f "Place" } in 1769.^[103] He died in Lenox{ XE "USA, Massachusetts, Berkshire, Lenox:(42.3565° N, 73.2849° W):Sears, Calvin (1769–1859)" \f "Place" } on 6th March 1859, at the age of 90.^[103]
- m VI. **Elijah Sears**{ XE "Sears: Elijah (1771–)" \f "Name" \b } was born at perhaps in Lenox{ XE "USA, Massachusetts, Berkshire, Lenox:(42.3565° N, 73.2849° W):Sears, Elijah (1771–)" \f "Place" } in 1771.
- + 73 m VII. **Luther Sears**{ XE "Sears: Luther (1774–1857)" \f "Name" } was born in Lenox{ XE "USA, Massachusetts, Berkshire, Lenox:(42.3565° N, 73.2849° W):Sears, Luther (1774–

¹⁰³ Ancestry.com, Massachusetts, Death Records, 1841-1915 (Provo, UT, USA, Ancestry.com Operations, Inc., 2013), Ancestry.com.

1857)" \f "Place" } on 28th September 1774.^[104] He died in Volney, Oswego, New York,{ XE "USA, New York, Oswego, Volney:(43.3428° N, 76.3581° W):Sears, Luther (1774-1857)" \f "Place" } in July 1857 at the age of 82.^[104]

- + 75 f VIII. **Elizabeth Sears**{ XE "Sears:Elizabeth (1775-)" \f "Name" } was born in Lenox{ XE "USA, Massachusetts, Berkshire, Lenox:(42.3565° N, 73.2849° W):Sears, Elizabeth (1775-)" \f "Place" } in 1775.
- + 77 m IX. **James Sears**{ XE "Sears:James (1776-1847)" \f "Name" } was born in Lenox{ XE "USA, Massachusetts, Berkshire, Lenox:(42.3565° N, 73.2849° W):Sears, James (1776-1847)" \f "Place" } on 15th May 1776.^[96, 105] He died in Richford, Tioga, New York,{ XE "USA, New York, Tioga, Richford:(42.3556° N, 76.2011° W):Sears, James (1776-1847)" \f "Place" } on 22nd February 1847, at the age of 70.^[96, 105]
- + 79 f X. **Polly Sears**{ XE "Sears:Polly (1777-)" \f "Name" } was born in Lenox{ XE "USA, Massachusetts, Berkshire, Lenox:(42.3565° N, 73.2849° W):Sears, Polly (1777-)" \f "Place" } in 1777.
- + 81 m XI. **Zachariah Sears**{ XE "Sears:Zachariah (1778-1865)" \f "Name" } was born in Lenox{ XE "USA, Massachusetts, Berkshire, Lenox:(42.3565° N, 73.2849° W):Sears, Zachariah (1778-1865)" \f "Place" } in April 1778.^[103, 106] He died in Lenox{ XE "USA, Massachusetts, Berkshire, Lenox:(42.3565° N, 73.2849° W):Sears, Zachariah (1778-1865)" \f "Place" } on 17th November 1865, at the age of 87.^[103, 106]

Family of Sarah Sears and Reuben Crosby{ TC "Sarah Sears and Reuben Crosby" \I 3 \f C}

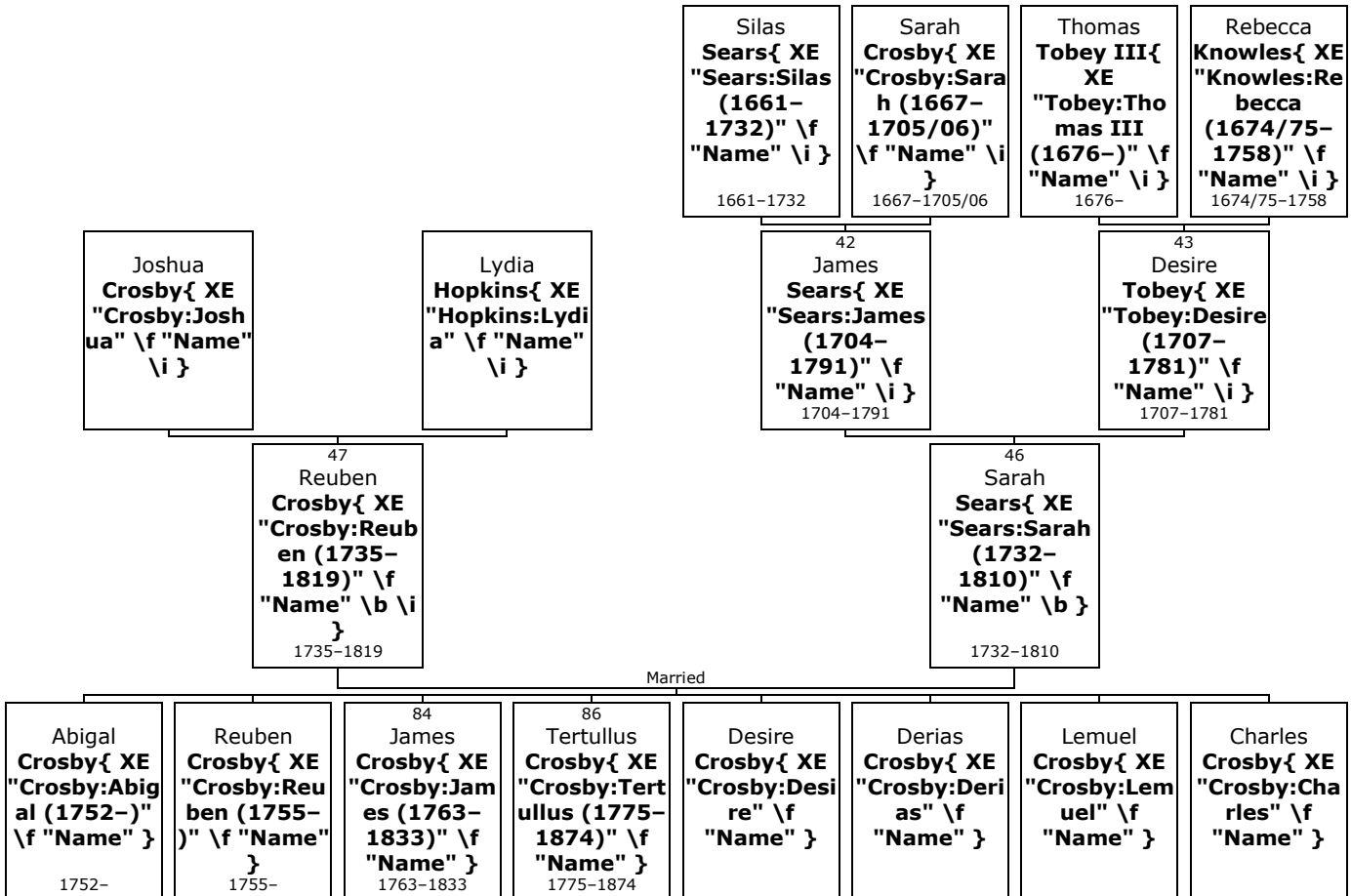

¹⁰⁴ Ancestry.com, U.S., Find A Grave Index, 1600s-Current (Provo, UT, USA, Ancestry.com Operations, Inc., 2012), <https://www.findagrave.com/memorial/95327602>.

¹⁰⁵ Ancestry.com, U.S., Sons of the American Revolution Membership Applications, 1889-1970 (Provo, UT, USA, Ancestry.com Operations, Inc., 2011), Ancestry.com.

¹⁰⁶ Ancestry.com, North America, Family Histories, 1500-2000 (Provo, UT, USA, Ancestry.com Operations, Inc., 2016), Ancestry.com, Book Title: Thatcher - Thatcher Genealogy : Part 1 : Coat-of-Arms.

46. **Sarah³ Sears**{ XE "Sears:Sarah (1732-1810)" \f "Name" \b } (*James²*) was born on 21st November 1732, in Yarmouth, Barnstable, Massachusetts, USA{ XE "USA, Massachusetts, Barnstable, Yarmouth:(41.7057° N, 70.2286° W):Sears, Sarah (1732-1810)" \f "Place" }. She was the daughter of James Sears{ XE "Sears:James (1704-1791)" \f "Name" \i } (42) and Desire Tobey{ XE "Tobey:Desire (1707-1781)" \f "Name" \i } (43).

Sarah died in 1810 at the age of 77.

!VTL Lived in Patterson, NY !SPM No 295 NEHGS- m. vol 102 p. 53

47. She married **Reuben Crosby**{ XE "Crosby:Reuben (1735-1819)" \f "Name" \b \i }. They had eight children: Abigal (1752-), Reuben (1755-), James (1763-1833), Tertullus (1775-1874), Desire, Derias, Lemuel and Charles.

Reuben was born in Harwich{ XE "USA, Massachusetts, Barnstable, Harwich:(41.6862° N, 70.0758° W):Crosby, Reuben (1735-1819)" \f "Place" } on 1st January 1735. He was the son of Joshua Crosby{ XE "Crosby:Joshua" \f "Name" \i } and Lydia Hopkins{ XE "Hopkins:Lydia" \f "Name" \i }.

Reuben reached 84 years of age and died in Patterson, Putnam, New York,{ XE "USA, New York, Putnam, Patterson:(41.5136° N, 73.6067° W):Crosby, Reuben (1735-1819)" \f "Place" } in 1819.

!http://trees.ancestry.com/owt/person.aspx?pid=11548424

Children of Sarah Sears and Reuben Crosby:

- | | | |
|------|---|--|
| | f | I. Abigal⁴ Crosby { XE "Crosby:Abigal (1752-)" \f "Name" \b } was born in perh, Yarmouth, Barnstable, Massachusetts,{ XE "USA, Massachusetts, Barnstable, Yarmouth, perh: :Crosby, Abigal (1752-)" \f "Place" } in 1752. |
| | m | II. Reuben Crosby { XE "Crosby:Reuben (1755-)" \f "Name" \b } was born in 1755. |
| + 84 | m | III. James Crosby { XE "Crosby:James (1763-1833)" \f "Name" } was born in Putnam, New York,{ XE "USA, New York, Putnam:(41.4314° N, 73.7464° W):Crosby, James (1763-1833)" \f "Place" } in 1763. He died in 1833 at the age of 70. |
| + 86 | m | IV. Tertullus Crosby { XE "Crosby:Tertullus (1775-1874)" \f "Name" } was born in Patterson, Putnam,{ XE "USA, New York, Putnam, Patterson:(41.5136° N, 73.6067° W):Crosby, Tertullus (1775-1874)" \f "Place" } on 2 nd February 1775. He died in Troy, Newaygo, Michigan,{ XE "USA, Michigan, Newaygo, Troy:(43.7431° N, 86.0192° W):Crosby, Tertullus (1775-1874)" \f "Place" } on 14 th September 1874, at the age of 99. |
| | f | V. Desire Crosby { XE "Crosby:Desire" \f "Name" \b }. |
| | m | VI. Derias Crosby { XE "Crosby:Derias" \f "Name" \b }. |
| | m | VII. Lemuel Crosby { XE "Crosby:Lemuel" \f "Name" \b }. |
| | m | VIII. Charles Crosby { XE "Crosby:Charles" \f "Name" \b } was born in Otsego{ XE "USA, New York, Otsego:(42.6337° N, 75.0354° W):Crosby, Charles" \f "Place" }. |

Family of Thankful Sears and James Foster{ TC "Thankful Sears and James Foster" \i 3 \f C}

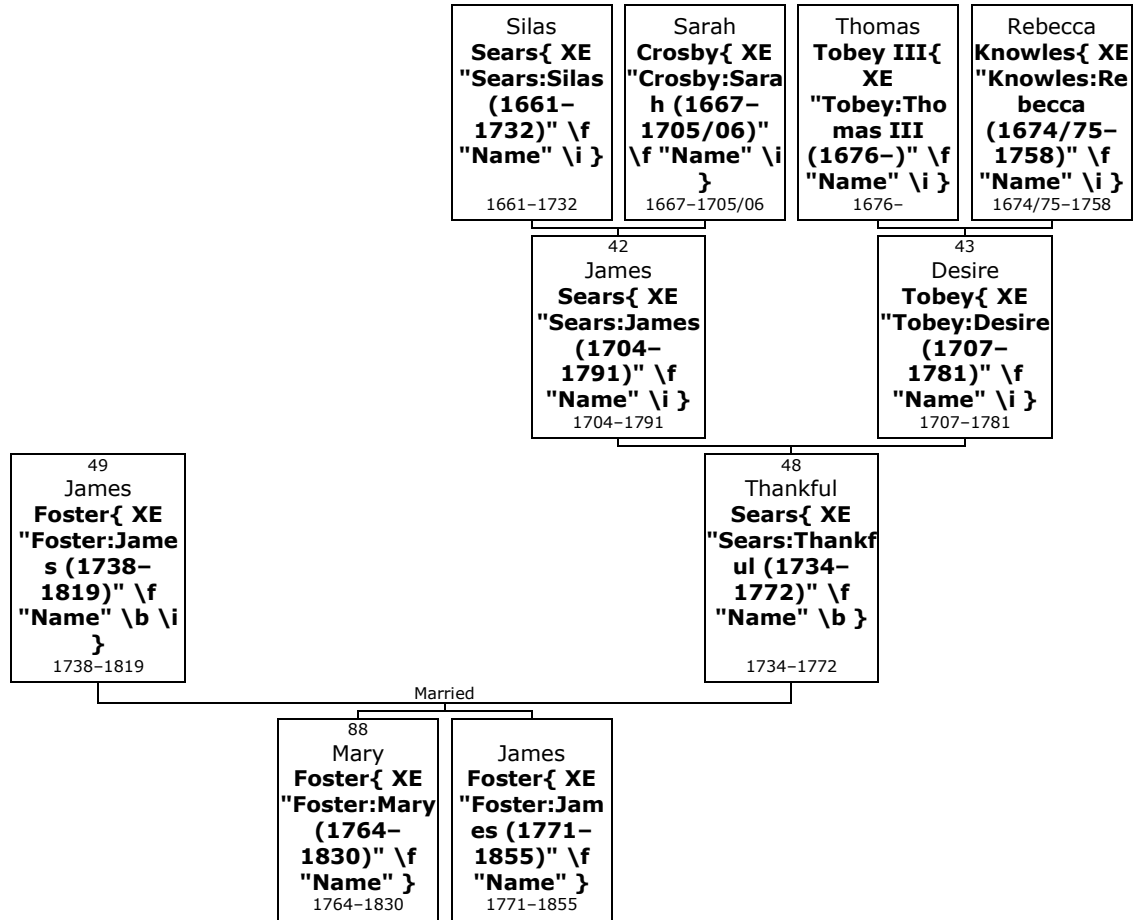

48. **Thankful³ Sears{ XE "Sears:Thankful (1734-1772)" \f "Name" \b }** (*James²*) was born on 26th November 1734, in Yarmouth, Barnstable, Massachusetts, USA{ XE "USA, Massachusetts, Barnstable, Yarmouth:(41.7057° N, 70.2286° W):Sears, Thankful (1734-1772)" \f "Place" }. She was the daughter of James Sears{ XE "Sears:James (1704-1791)" \f "Name" \i } (42) and Desire Tobey{ XE "Tobey:Desire (1707-1781)" \f "Name" \i } (43).

Thankful died in Milltown, New York,{ XE "USA, New York, Milltown: :Sears, Thankful (1734-1772)" \f "Place" } on 27th July 1772, at the age of 37. She was buried in Milltown{ XE "USA, New York, Milltown: :Sears, Thankful (1734-1772)" \f "Place" }.

!S P May No 296, gr-st

!Virginia T Lake of Delaware-- Lived at Southeast, NY

<https://www.wikitree.com/wiki/Sears-879>

See <https://archive.org/details/fostergenealogy03pier/page/558/mode/2up>

Mother of Mary Foster, Abigail (Foster) Crosby, Edmund Foster, Elizabeth Foster and James Foster

49. She married **James Foster{ XE "Foster:James (1738-1819)" \f "Name" \b \i }**. They had two children: Mary (1764-1830) and James (1771-1855).

James was born in perh, Yarmouth, Barnstable, Massachusetts,{ XE "USA, Massachusetts, Barnstable, Yarmouth, perh: :Foster, James (1738-1819)" \f "Place" } in 1738. He reached 81 years of age and died on 18th August 1819.

PA001 - J Kelsey Jones !gr-st

Children of Thankful Sears and James Foster:

- + 88 f I. **Mary⁴ Foster**{ XE "Foster:Mary (1764-1830)" \f "Name" } was born in perh{ XE "USA, Massachusetts, Barnstable, Yarmouth, perh: :Foster, Mary (1764-1830)" \f "Place" } in 1764. She died in 1830 at the age of 66.
- m II. **James Foster**{ XE "Foster:James (1771-1855)" \f "Name" \b } was born in perh{ XE "USA, Massachusetts, Barnstable, Yarmouth, perh: :Foster, James (1771-1855)" \f "Place" } in 1771. He died in 1855 at the age of 84.

Family of Seth Sears and Sarah Sears{ TC "Seth Sears and Sarah Sears" \I 3 \f C}

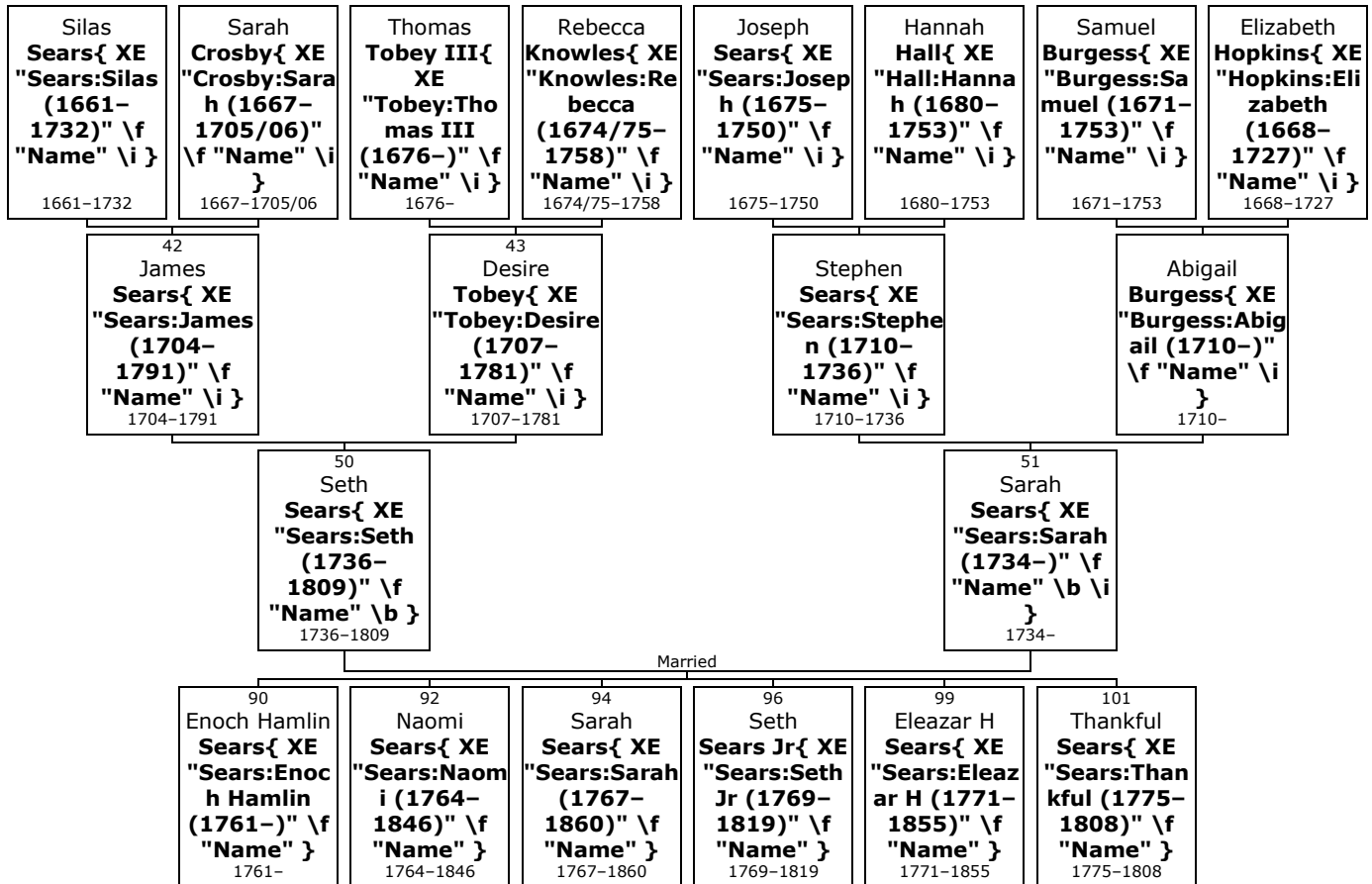

50. **Seth³ Sears**{ XE "Sears:Seth (1736-1809)" \f "Name" \b } (*James*²) was born on 31st October 1736, in Yarmouth, Barnstable, Massachusetts, USA{ XE "USA, Massachusetts, Barnstable, Yarmouth:(41.7057° N, 70.2286° W):Sears, Seth (1736-1809)" \f "Place" }.^[107, 108, 109, 110-111] He was the son of James Sears{ XE "Sears:James (1704-1791)" \f "Name" \i } (42) and Desire Tobey{ XE "Tobey:Desire (1707-1781)" \f "Name" \i } (43).

¹⁰⁷ Ancestry.com, Massachusetts, Town and Vital Records, 1620-1988 (Provo, UT, USA, Ancestry.com Operations, Inc., 2011), Ancestry.com.
[Source citation includes one media item]

¹⁰⁸ Ancestry.com, New York, Genealogical Records, 1675-1920 (Provo, UT, USA, Ancestry.com Operations Inc, 2004), Ancestry.com, 1790 Federal Census of New York State; Publication Place: Washington, D.C.; Publisher: Government Printing Office; Publication Year: 1908; Page Number: 93.

¹⁰⁹ Ancestry.com, Web: New York, Find A Grave Index, 1660-2012 (Provo, UT, USA, Ancestry.com Operations, Inc., 2012), Ancestry.com.

¹¹⁰ Ancestry.com, 1790 United States Federal Census (Provo, UT, USA, Ancestry.com Operations, Inc., 2010), Ancestry.com, Year: 1790; Census Place: Southeast, Dutchess, New York; Series: M637; Roll: 6; Page: 34; Image: 161; Family History Library Film: 0568146.
[Source citation includes one media item]

¹¹¹ Ancestry.com, U.S., Find A Grave Index, 1600s-Current (Provo, UT, USA, Ancestry.com Operations, Inc., 2012), Ancestry.com.

Seth died in Milltown{ XE "USA, New York, Milltown: :Sears, Seth (1736–1809)" \f "Place" } on 2nd August 1809, at the age of 72.^[109, 111] He was buried in Milltown Cemetery, Southeast, Putnam{ XE "USA, New York, Putnam, Southeast, Milltown Cemetery: :Sears, Seth (1736–1809)" \f "Place" }.^[109, 111]

!S.P. May p.174, No 297, buried beside his brother Knowles Ruth Gormley Pickard -

<https://www.wikitree.com/wiki/Sears-77>

!

!Seth Sears is listed in Rolls of CT Men in the French and Indian War, 1755-1762, on the muster Roll of the 1st Co, 4th Regt under Col David Wooster, also Capt, 1st Co. He is listed as a private enlisting 4 Apr 1758. he was discharged 15 Nov 1758. Seth Sears is also listed on the Muster Roll of the 9th Co [Capt Thaddeus Mead (of Norwalk)] of the 3rd regt (Col David Wooster). He did not join for the campaign of 1759. He served as a private in Capt Azor Barnum's Co., Col John Field's Regt (Third) of the Dutchess County Militia. NY in the Rev. p.40 On 4 Apr 1783, Seth Sears took advantage of the attinder of former Colonial Governor Henry Clinton to purchase for the sum of 63 pounds a 105-acre tract of land in the Oblong, which had been seized by the Committee to Detect Conspiracies.

Don't confuse this Seth with FTM Richard-Paul-Samuel-Benjamin-Seth they both served in the war and died in Putnam

More facts and events for Seth Sears:

Residence: 1790 Southeast{ XE "USA, New York, Putnam, Southeast:(41.4054° N, 73.6001° W):Sears, Seth (1736–1809)" \f "Place" }.^[110]

- 51.** He married **Sarah Sears**{ XE "Sears:Sarah (1734–)" \f "Name" \b \i }. They had six children: Enoch (1761–), Naomi (1764–1846), Sarah (1767–1860), Seth (1769–1819), Eleazar (1771–1855) and Thankful (1775–1808).

Sarah was born in Yarmouth, Barnstable, Massachusetts,{ XE "USA, Massachusetts, Barnstable, Yarmouth:(41.7057° N, 70.2286° W):Sears, Sarah (1734–)" \f "Place" } on 31st March 1734. She was the daughter of Stephen Sears{ XE "Sears:Stephen (1710–1736)" \f "Name" \i } and Abigail Burgess{ XE "Burgess:Abigail (1710–)" \f "Name" \i }.

!S P May No 324 Yarmouth VR [p.103] Sarah Sears the daughter of Stephen and Abagill Sears she was born on the last day of March in the year of our Lord 1734

Children of Seth Sears and Sarah Sears:

- + 90 m I. **Enoch Hamlin⁴ Sears**{ XE "Sears:Enoch Hamlin (1761–)" \f "Name" } was born in Southeast, Putnam, New York,{ XE "USA, New York, Putnam, Southeast:(41.4054° N, 73.6001° W):Sears, Enoch Hamlin (1761–)" \f "Place" } in 1761.
- + 92 f II. **Naomi Sears**{ XE "Sears:Naomi (1764–1846)" \f "Name" } was born in prob, Southeast,{ XE "USA, New York, Putnam, Southeast, prob: :Sears, Naomi (1764–1846)" \f "Place" } on 23rd September 1764. She died in Winfield, Herkimer,{ XE "USA, New York, Herkimer, Winfield:(42.8973° N, 75.1663° W):Sears, Naomi (1764–1846)" \f "Place" } on 30th March 1846, at the age of 81.
- + 94 f III. **Sarah Sears**{ XE "Sears:Sarah (1767–1860)" \f "Name" } was born in Southeast{ XE "USA, New York, Putnam, Southeast:(41.4054° N, 73.6001° W):Sears, Sarah (1767–1860)" \f "Place" } on 24th March 1767. She died on 26th September 1860, at the age of 93.
- + 96 m IV. **Seth Sears Jr**{ XE "Sears:Seth Jr (1769–1819)" \f "Name" } was born in perh, Southeast,{ XE "USA, New York, Putnam, Southeast, perh: :Sears, Seth Jr (1769–1819)" \f "Place" } on 11th August 1769. He died in Milltown{ XE "USA, New York, Putnam, Milltown: :Sears, Seth Jr (1769–1819)" \f "Place" } on 1st May 1819, at the age of 49.
- + 99 m V. **Eleazar H Sears**{ XE "Sears:Eleazar H (1771–1855)" \f "Name" } was born in Danbury or{ XE "USA, New York, Putnam, Southeast, Danbury or: :Sears, Eleazar H (1771–1855)" \f "Place" } in 1771. He died in De Ruyter, Madison,{ XE "USA, New York, Madison, De Ruyter:(42.7585° N, 75.8868° W):Sears, Eleazar H (1771–1855)" \f "Place" } in 1855 at the age of 84.^[111]

+ 101 f VI. **Thankful Sears**{ XE "Sears:Thankful (1775-1808)" \f "Name" } was born in Southeast{ XE "USA, New York, Putnam, Southeast:(41.4054° N, 73.6001° W):Sears, Thankful (1775-1808)" \f "Place" } on 30th June 1775. She died in Litchfield, Herkimer,{ XE "USA, New York, Herkimer, Litchfield:(42.9776° N, 75.1507° W):Sears, Thankful (1775-1808)" \f "Place" } on 28th July 1808, at the age of 33.

Family of Thomas Sears and Deborah Baldwin{ TC "Thomas Sears and Deborah Baldwin" \I 3 \f C}

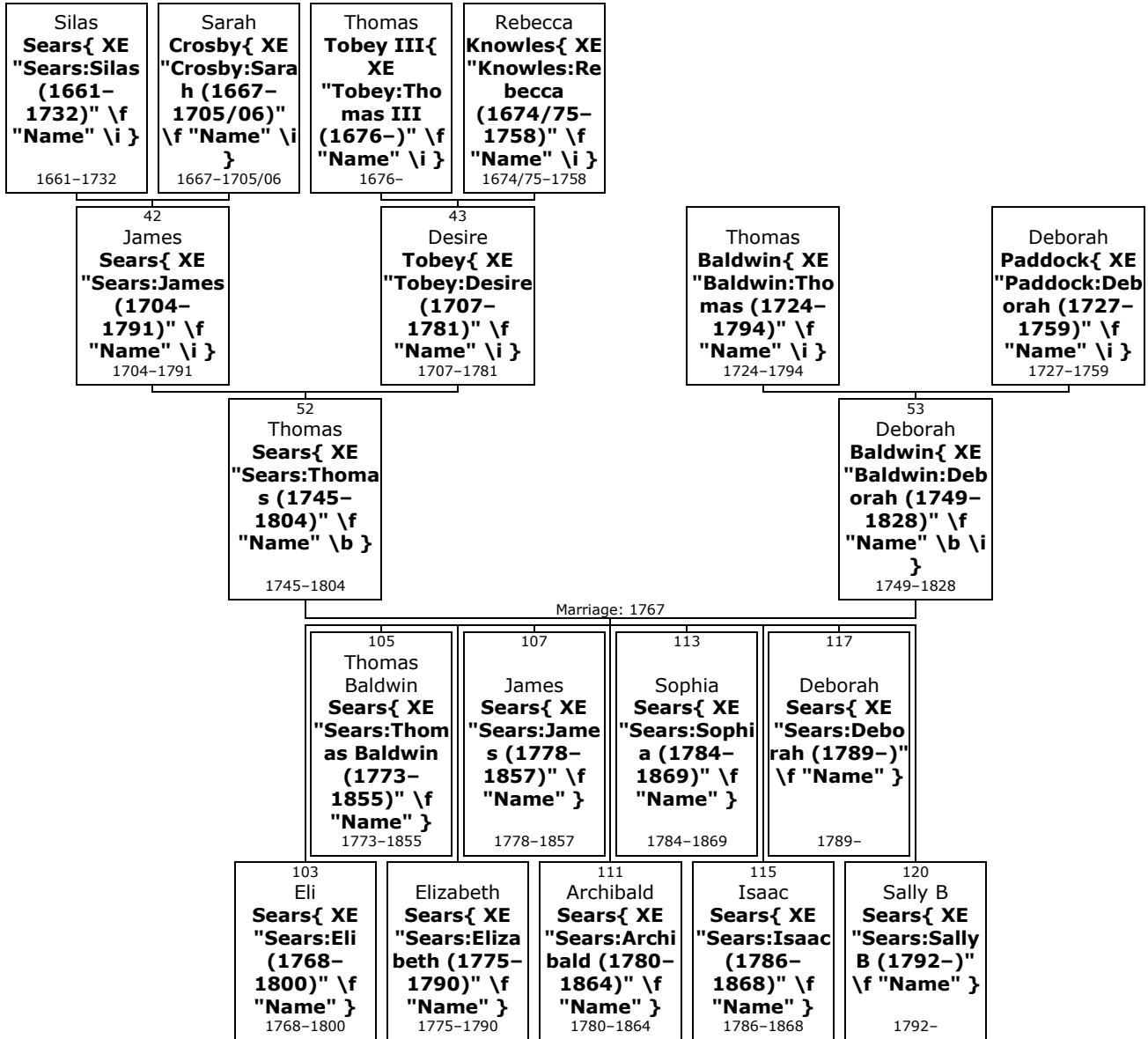

52. **Capt Thomas³ Sears**{ XE "Sears:Thomas (1745-1804)" \f "Name" \b } (*James²*) was born on 30th April 1745, in New York, USA{ XE "USA, New York:(42.7531° N, 74.2224° W):Sears, Thomas (1745-1804)" \f "Place" }.^[112, 113-114] He was the son of James Sears{ XE "Sears:James (1704-1791)" \f "Name" \i } (42) and Desire Tobey{ XE "Tobey:Desire (1707-1781)" \f "Name" \i } (43).

¹¹² Yates Publishing, U.S. and International Marriage Records, 1560-1900 (Provo, UT, USA, Ancestry.com Operations Inc, 2004), Ancestry.com, Source number: 3430.008; Source type: Pedigree chart; Number of Pages: 13.

¹¹³ Ancestry.com, North America, Family Histories, 1500-2000 (Provo, UT, USA, Ancestry.com Operations, Inc., 2016), Ancestry.com, Book Title: Lineage Book of the Charter Members of the DAR Vol 085. [Source citation includes one media item]

¹¹⁴ Ancestry.com, U.S., Sons of the American Revolution Membership Applications, 1889-1970 (Provo, UT, USA, Ancestry.com Operations, Inc., 2011), Ancestry.com, Volume: 156. [Source citation includes one media item]

Thomas died in Southeast, Putnam, New York, { XE "USA, New York, Putnam, Southeast:(41.4054° N, 73.6001° W):Sears, Thomas (1745–1804)" \f "Place" } on 26th April 1804, at the age of 58.^[113, 114] He was buried in Sears Burying Ground, Southeast { XE "USA, New York, Putnam, Southeast, Sears Burying Ground: :Sears, Thomas (1745–1804)" \f "Place" }.

<https://www.wikitree.com/wiki/Sears-882>

!S.P. May p.178, No 299, Thomas Sears was a captain in the Revolutionary Army, and after the peace settled in South East, Putnam county, NY on land which he bought of the government, and on which his descendants still live. He was a prominent church member and trustee during many years.

!DAR note Thomas Sears served as lieutenant in the Third regiment of the Dutchess county militia. Lineage Book of the Charter Members of the DAR Vol 085 p. 308- Mrs Grace Sears Snyder #84795 wife of Robert William Snyder. Descendant of Benjamin Sears, Capt Knowles Sears, Lieut Thomas Sears, John Strother, and Capt Charles Browning

parents: George W Sears (1841-) m. 1862 Angeline Yates

...https://www.ancestry.com/interactive/61157/46155_b290224-00314/2573240?backurl=https://www.ancestry.com/family-tree/person/tree/7346183/person/-1098656709/facts/citation/640031303862/edit/record?imageId=46155_b290224-00315

!SEARS, Thomas Cem Southeast Twp, Putnam Co NY 35 Abstract of Graves of Revolutionary Patriots, Vol.4, p. -Serial: 10000; Volume: 2 Abstracts of Wills, Admins. and Guardianships in NY State, 1787-1835

- 53.** At the age of 22, Thomas married **Deborah Baldwin** { XE "Baldwin:Deborah (1749–1828)" \f "Name" \b \i } on Wednesday, 9th September 1767, when she was 17 years old.^[112–114] They had nine children: Eli (1768–1800), Thomas (1773–1855), Elizabeth (1775–1790), James (1778–1857), Archibald (1780–1864), Sophia (1784–1869), Isaac (1786–1868), Deborah (1789–) and Sally (1792–).

Deborah was born in perh { XE "USA, New York, Putnam, Southeast, perh: :Baldwin, Deborah (1749–1828)" \f "Place" } on 23rd November 1749.^[112–114] She was the daughter of Thomas Baldwin { XE "Baldwin:Thomas (1724–1794)" \f "Name" \i } and Deborah Paddock { XE "Paddock:Deborah (1727–1759)" \f "Name" \i }.

Deborah reached 78 years of age and died in Southeast { XE "USA, New York, Putnam, Southeast:(41.4054° N, 73.6001° W):Baldwin, Deborah (1749–1828)" \f "Place" } on 13th September 1828.^[113, 114] She was buried in Sears Burying Gd, Southeast { XE "USA, New York, Putnam, Southeast, Sears Burying Gd: :Baldwin, Deborah (1749–1828)" \f "Place" }.

Children of Thomas Sears and Deborah Baldwin:

- + 103 m I. **Eli⁴ Sears** { XE "Sears:Eli (1768–1800)" \f "Name" } was born in Southeast { XE "USA, New York, Putnam, Southeast:(41.4054° N, 73.6001° W):Sears, Eli (1768–1800)" \f "Place" } on 16th October 1768.^[114, 115] He died in Carmel { XE "USA, New York, Putnam, Carmel:(41.4301° N, 73.6801° W):Sears, Eli (1768–1800)" \f "Place" } on 16th March 1800, at the age of 31.^[114, 115]
- + 105 m II. **Thomas Baldwin Sears** { XE "Sears:Thomas Baldwin (1773–1855)" \f "Name" } was born in Southeast { XE "USA, New York, Putnam, Southeast:(41.4054° N, 73.6001° W):Sears, Thomas Baldwin (1773–1855)" \f "Place" } on 21st February 1773. He died in Carmel { XE "USA, New York, Putnam, Carmel:(41.4301° N, 73.6801° W):Sears, Thomas Baldwin (1773–1855)" \f "Place" } in March 1855 at the age of 82.
- f III. **Elizabeth Sears** { XE "Sears:Elizabeth (1775–1790)" \f "Name" \b } was born in Southeast { XE "USA, New York, Putnam, Southeast:(41.4054° N, 73.6001° W):Sears, Elizabeth (1775–1790)" \f "Place" } on 3rd September 1775. She died on 23rd September 1790, at the age of 15.
- + 107 m IV. **James Sears** { XE "Sears:James (1778–1857)" \f "Name" } was born in Southeast { XE "USA, New York, Putnam, Southeast:(41.4054° N, 73.6001° W):Sears, James (1778–1857)" \f "Place" } on 24th March 1778.^[116] He died in March 1857 at the age of 78.^[116]
- + 111 m V. **Archibald Sears** { XE "Sears:Archibald (1780–1864)" \f "Name" } was born in Carmel { XE "USA, New York, Putnam, Carmel:(41.4301° N, 73.6801° W):Sears, Archibald (1780–

¹¹⁵ Ancestry.com, U.S., Sons of the American Revolution Membership Applications, 1889-1970 (Provo, UT, USA, Ancestry.com Operations, Inc., 2011), Ancestry.com, Volume: 143.

¹¹⁶ "Ancestry Family Tree", Record for Deborah Sears.
<https://www.ancestry.com/family-tree/tree/58968303/person/36462791358>.

1864)" \f "Place" } on 8th August 1780. He died in Southeast{ XE "USA, New York, Putnam, Southeast:(41.4054° N, 73.6001° W):Sears, Archibald (1780–1864)" \f "Place" } on 27th October 1864, at the age of 84.^[117]

- + 113 f VI. **Sophia Sears**{ XE "Sears:Sophia (1784–1869)" \f "Name" } was born in Southeast{ XE "USA, New York, Putnam, Southeast:(41.4054° N, 73.6001° W):Sears, Sophia (1784–1869)" \f "Place" } on 12th May 1784. She died on 12th April 1869, at the age of 84.
- + 115 m VII. **Isaac Sears**{ XE "Sears:Isaac (1786–1868)" \f "Name" } was born in Southeast, Dutchess,{ XE "USA, New York, Dutchess, Southeast: :Sears, Isaac (1786–1868)" \f "Place" } on 23rd July 1786.^[113, 118] He died in Berlin Heights, Ohio,{ XE "USA, Ohio, Berlin Heights: :Sears, Isaac (1786–1868)" \f "Place" } in January 1868 at the age of 81.^[118]
- + 117 f VIII. **Deborah Sears**{ XE "Sears:Deborah (1789–)" \f "Name" } was born in Southeast, Putnam,{ XE "USA, New York, Putnam, Southeast:(41.4054° N, 73.6001° W):Sears, Deborah (1789–)" \f "Place" } on 18th October 1789.
- + 120 f IX. **Sally B Sears**{ XE "Sears:Sally B (1792–)" \f "Name" } was born in Southeast{ XE "USA, New York, Putnam, Southeast:(41.4054° N, 73.6001° W):Sears, Sally B (1792–)" \f "Place" } on 26th June 1792.

Family of Desire Sears and Timothy Foster{ TC "Desire Sears and Timothy Foster" \I 3 \f C}

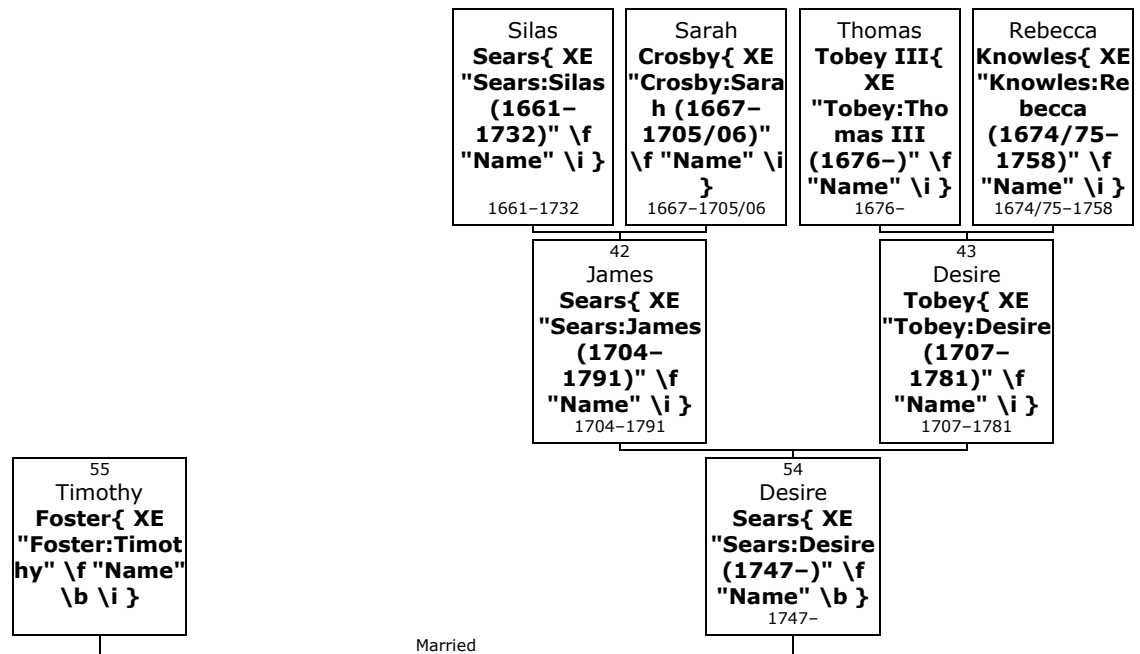

54. **Desire³ Sears**{ XE "Sears:Desire (1747–)" \f "Name" \b } (*James²*) was born in 1747 in perh, Yarmouth, Barnstable, Massachusetts, USA{ XE "USA, Massachusetts, Barnstable, Yarmouth, perh: :Sears, Desire (1747–)" \f "Place" }. She was the daughter of James Sears{ XE "Sears:James (1704–1791)" \f "Name" \i } (42) and Desire Tobey{ XE "Tobey:Desire (1707–1781)" \f "Name" \i } (43).

!S P May No 300

!

!Ridgefield, CT (2nd Church) Marriage Records 1769 to 1800 From Early Connecticut Marriages Prior to 1800 By Frederick W. Bailey The town of Ridgefield was incorporated October, 1709. The township was purchased of the Indians by a company of twenty-nine individuals from Norwalk and Milford, 1707–8. The First Congregational Church was organized in 1712 and is located at Ridgefield Center. The Second

¹¹⁷ Ancestry.com, U.S., Find A Grave Index, 1600s-Current (Provo, UT, USA, Ancestry.com Operations, Inc., 2012), Ancestry.com.

¹¹⁸ "Ancestry Family Tree", Record for George Sears-<https://www.ancestry.com/family-tree/tree/112169379/person/232092345437>. <https://search.ancestry.com/cgi-bin/sse.dll?db=1030&h=232092345437&indiv=try>.

Congregational Church is at Ridgebury and was organized January 18, 1769. The following are the marriages from the Second Church records. Rev. Samuel Camp pastor from 1769 to 1804. Timothy Foster and Desire Sears --- Nov. 19, 1772

55. Desire married **Timothy Foster**{ XE "Foster:Timothy" \f "Name" \b \i }.

Family of James Sears and Elizabeth Olmstead{ TC "James Sears and Elizabeth Olmstead" \I 3 \f C}

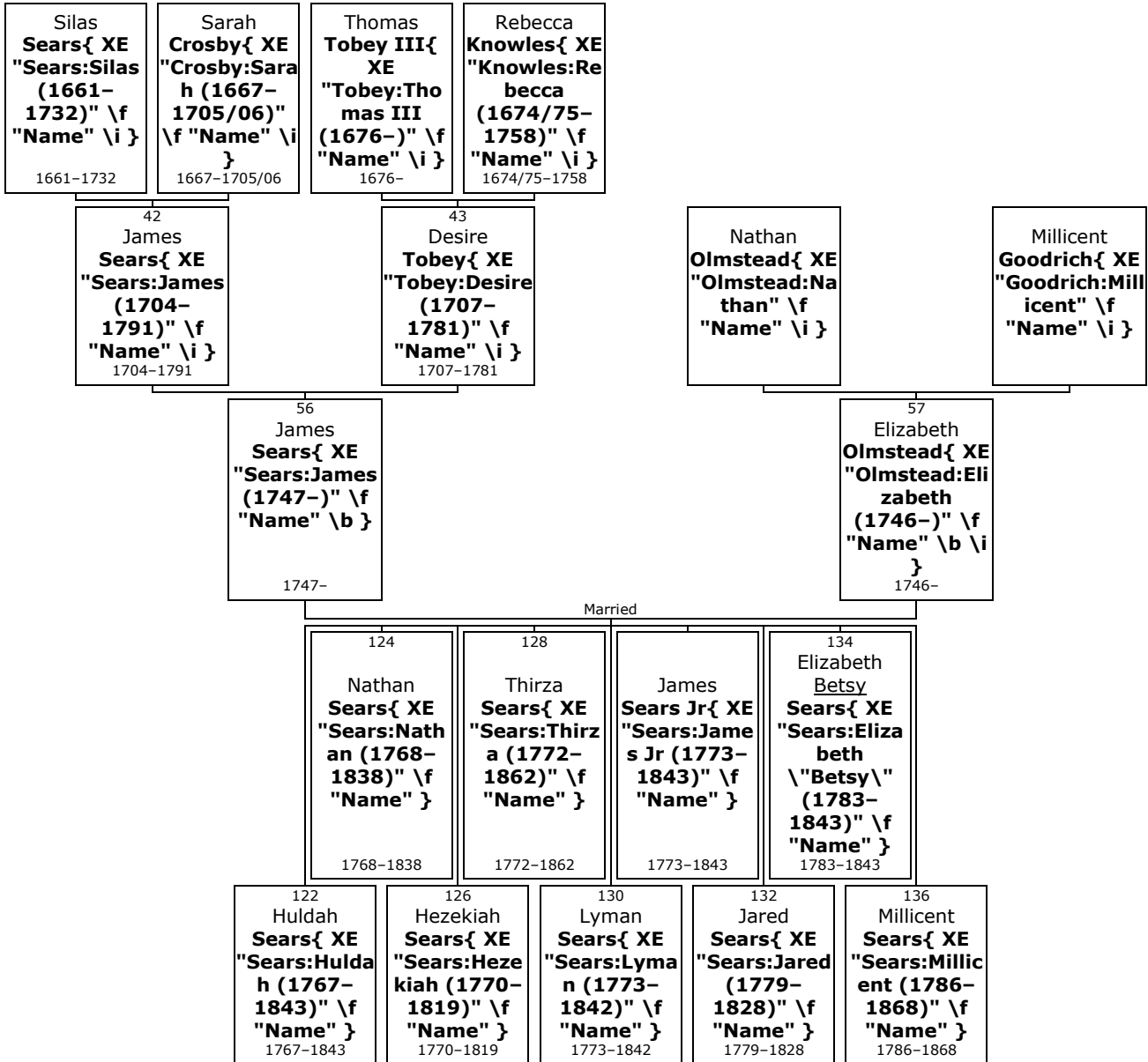

56. **James³ Sears**{ XE "Sears:James (1747-)" \f "Name" \b } (*James²*) was born in 1747 in perh, Yarmouth, Barnstable, Massachusetts, USA{ XE "USA, Massachusetts, Barnstable, Yarmouth, perh: :Sears, James (1747-)" \f "Place" }. He was the son of James Sears{ XE "Sears:James (1704-1791)" \f "Name" \i } (42) and Desire Tobey{ XE "Tobey:Desire (1707-1781)" \f "Name" \i } (43).

James died in Quebec, Canada{ XE "Canada, Quebec:(47.4278° N, 71.8805° W):Sears, James (1747-)" \f "Place" }.

<https://www.wikitree.com/wiki/Sears-867>

!See also RIN 6046

!

!S P May, p 178, thought that this James married Abigail Sherwood, dau of Jehiel Sherwood and listed seven children of that marriage. There was confusion by May - he confused THIS James with his nephew

James [RIN 6027], son of his brother Thomas, who married Mehitabel "Mable" Sherwood - younger sister of Abigail.

Abigail Sherwood - the daughter of Jehiel Sherwood, was born 17 Feb 1777, and married Nathaniel Hibbard. Ida Fitchard completed a DAR application with Abigail's info and is a direct descendant of Abigail.

!

!Diane Sears Brigode- email, 8 Jul 1996 James is also the ancestor of Vivian West Broberg and Richard E Sears and lived in Lenox, MA was in Capt Oliver Beldings Co, Maj Caleb Hyde's Regt, 8 Jul to 26 Jul 1778, in Northern Dept. He removed to the "Lake Region" of Canada. Diane's research indicates that this man is the father of the nine children listed here. Many Quebec land petitions prove that James moved his family up from Bennington, VT about 1786 - took land in Caldwell Manor, Quebec, at first, petitioned for land in a couple of other townships, and finally was accepted as an original grantee at Sutton.

!

! Richard E Sears - My Sears line left the United Colonies during or after the revolution and settled in what became the Eastern Townships of Quebec. A Royal Letter patent for Aug 1802 listing 170 grantees of land in what became the town of Sutton, Quebec included the following: Jerod Sears, James Sears, Simon (Lyman) Sears, James Sears, Jr, Nathan Sears and Hezekiah Sears. A grantee named Ephraim Hawley, Jr., was the husband of Thirza Sears, sister of James Sears. These were children of James Sears and Elizabeth Olmstead. This family connection has been emphasized and passed down in the Hawley family and the members of my family remaining in Sutton. The Hawleys and Sears were also petitioners together with Levi Allen, Brother of Ethan Allen for Crown land in Canada as early as 1786.

!

!There is a "Sears" access point in Vermont on the Lamoille River near the town of Milton, VT. Probably some connection with this family.

http://www.vtfishandwildlife.com/library/Reports_and_Documents/Fishing/Access_Area_Information/Universal_ShorePlatform_list.pdf

From: Andrew Timleck [mailto:jtimpleck@mac.com] Sent: Friday, December 30, 2005 7:03 PMTo: LRSEARS@Cox.net

Subject: Working on transcription of Missiquoi docs with Sears in them - interested in a copy later?

Thought you might like a copy of the transcription I'm working on of the Land Committee of 1795-1796 which includes signatures of many of the Sears, Hezeziah, James, Jared, etc. Just let me know and will forward when complete. Happy New Year Best, Andrew Timleck Baltimore, MD

Elmer (Bud) Sears bsears4@cfl.rr.com 321-890-4464

Hi Ray, Wonderful Site you have. I have some additional information on the James Sears Family tree (See tab Below) My line is part of a confusion on Samuel Mays part and I am working to sort out what really is real. Any additional information you may be in possession of would be of great Help. (See prime tree tab below)The players involved are:

Mays #	Sears Assoc. #	Name
#282	#606	James
#301	#643	James

#1James Family Tree James #781#4James Additional information I could use help Locating Pelletreau (p.756) James (Pelletreau, p.269) Eleazer HAMBLIN (No.135 RIN13969) James SEARS, his brother-in-law, arrived to settle near the HAMBLINS in 1743. I would also like to find out more about the "DNA" testing project Please let me know what you think of my Hypothesis on the (Prime Tree tab Below) any information confirming or discrediting it would behelpful Thank You for a great Job

1. May is aware that James(# 282) is not in Barnstable, but alive in 1755 due to his fathers (#68 Silas) will.
2. May must have some idea he (#282) could be in or near Carmel Ny in 1747-1756 due to refference on Page 99

3. Both James #282 and James #301 were Maternal great-Grandsons of Rev. Thomas Crosby (James #73) (Silas #68) Grandsons

4. James #73 was married to Desire Tobey in 1743 (not Brother in law to Eleazer Hamblin) James (# 282) could have been we have no marriage data (Brother in law to Eleazer Hamblin)I think Perhaps the mother of James #1 may have been a Hamblin James (#301) not born till 1747 James (#1 James Sears Tree) not till 1747 Discrempcy begins at this point

5. Two James Sears Born in same area of NY? in 1747 (Same Family Cousins)

6. James Sears #1 of James Sears Family Tree is born in Catskill NY in 1747 no record of parents about 50 miles from Carmel NY.

7. James Sears (#4 of James Sears Family Tree) and Same Person as (James #781 May's) is born 1779 Catskill NY Mays Feels he(James #781) is of the family of James #301 (1st cousin To James #282) due to "Family Traditions" page #179 (James #301 from James #73)

8. The Birth names, dates and locations of the Children of James(#781 or #4) are consistant with May's narritive.and shows #781 in Canada in 1812, then NY, Ohio and Indiana.

My Hypothesis is that James(#282) son of Silas(#68) is the father of James(#1 of the James Sears Tree)and Granfather of

That James #781 was with or near his relatives the family of James #301 in Canada 1810-1812 and added to May's Confusion.

57. He married **Elizabeth Olmstead**{ XE "Olmstead:Elizabeth (1746-)" \f "Name" \b \i }. They had nine children: Huldah (1767-1843), Nathan (1768-1838), Hezekiah (1770-1819), Thirza (1772-1862), Lyman (1773-1842), James (1773-1843), Jared (1779-1828), Betsy (1783-1843) and Millicent (1786-1868).

Elizabeth was born in Ridgefield, Fairfield, Connecticut, USA,{ XE "USA, Connecticut, Fairfield, Ridgefield:(41.2815° N, 73.4982° W):Olmstead, Elizabeth (1746-)" \f "Place" } on 26th July 1746. She was the daughter of Nathan Olmstead{ XE "Olmstead:Nathan" \f "Name" \i } and Millicent Goodrich{ XE "Goodrich:Millicent" \f "Name" \i }.

DSB- Had brothers Nathan, David and Hezekaih and sister Millicent.

Children of James Sears and Elizabeth Olmstead:

- + 122 f I. **Huldah^f Sears**{ XE "Sears:Huldah (1767-1843)" \f "Name" } was born on 9th October 1767. She died in 1843 at the age of 75.
- + 124 m II. **Nathan Sears**{ XE "Sears:Nathan (1768-1838)" \f "Name" } was born on 22nd August 1768. He died in Shefford, La Haute-Yamaska, Quebec, Canada,{ XE "Canada, Quebec, La Haute-Yamaska, Shefford:(45.4167° N, 72.5833° W):Sears, Nathan (1768-1838)" \f "Place" } on 15th November 1838, at the age of 70.
- + 126 m III. **Hezekiah Sears**{ XE "Sears:Hezekiah (1770-1819)" \f "Name" } was born in Massachusetts{ XE "USA, Massachusetts:(42.1562° N, 71.5662° W):Sears, Hezekiah (1770-1819)" \f "Place" } in 1770. He died in Caldwell Manor, Quebec, Canada,{ XE "Canada, Quebec, Caldwell Manor: :Sears, Hezekiah (1770-1819)" \f "Place" } in 1819 at the age of 49.
- + 128 f IV. **Thirza Sears**{ XE "Sears:Thirza (1772-1862)" \f "Name" } was born in 1772. She died on 12th April 1862, at the age of 90.
- + 130 m V. **Lyman Sears**{ XE "Sears:Lyman (1773-1842)" \f "Name" } was born between 1773 and 1778. He died in 1842.
- + 132 m VI. **James Sears Jr**{ XE "Sears:James Jr (1773-1843)" \f "Name" \b } was born between 1773 and 1778. He died in 1843.
- + 134 f VII. **Jared Sears**{ XE "Sears:Jared (1779-1828)" \f "Name" } was born in Lenox, Berkshire, Massachusetts,{ XE "USA, Massachusetts, Berkshire, Lenox:(42.3565° N, 73.2849° W):Sears, Jared (1779-1828)" \f "Place" } on 12th August 1779. He died in Knowlesville, Orleans, New York,{ XE "USA, New York, Orleans, Knowlesville:(43.2419° N, 78.3108° W):Sears, Jared (1779-1828)" \f "Place" } on 6th February 1828, at the age of 48.
- + 136 f VIII. **Elizabeth Betsy Sears**{ XE "Sears:Elizabeth \"Betsy\" (1783-1843)" \f "Name" } was born in Arlington, Bennington, Vermont,{ XE "USA, Vermont, Bennington, Arlington:(43.0748° N, 73.154° W):Sears, Elizabeth \"Betsy\" (1783-1843)" \f "Place" } in August 1783. She died in Fletcher, Franklin,{ XE "USA, Vermont, Franklin, Fletcher:(44.6833° N, 72.9142° W):Sears, Elizabeth \"Betsy\" (1783-1843)" \f "Place" } on 6th July 1843, at the age of 59.
- + 136 f IX. **Millicent Sears**{ XE "Sears:Millicent (1786-1868)" \f "Name" } was born in Vermont{ XE "USA, Vermont:(43.8726° N, 71.55° W):Sears, Millicent (1786-1868)" \f "Place" } on 15th April 1786. She died in Shefford, La Haute-Yamaska, Quebec, Canada,{ XE "Canada, Quebec, La Haute-Yamaska, Shefford:(45.4167° N, 72.5833° W):Sears, Millicent (1786-1868)" \f "Place" } on 29th April 1868, at the age of 82.

Family of Rebecca Sears and Eli Crosby{ TC "Rebecca Sears and Eli Crosby" \i 3 \f C}

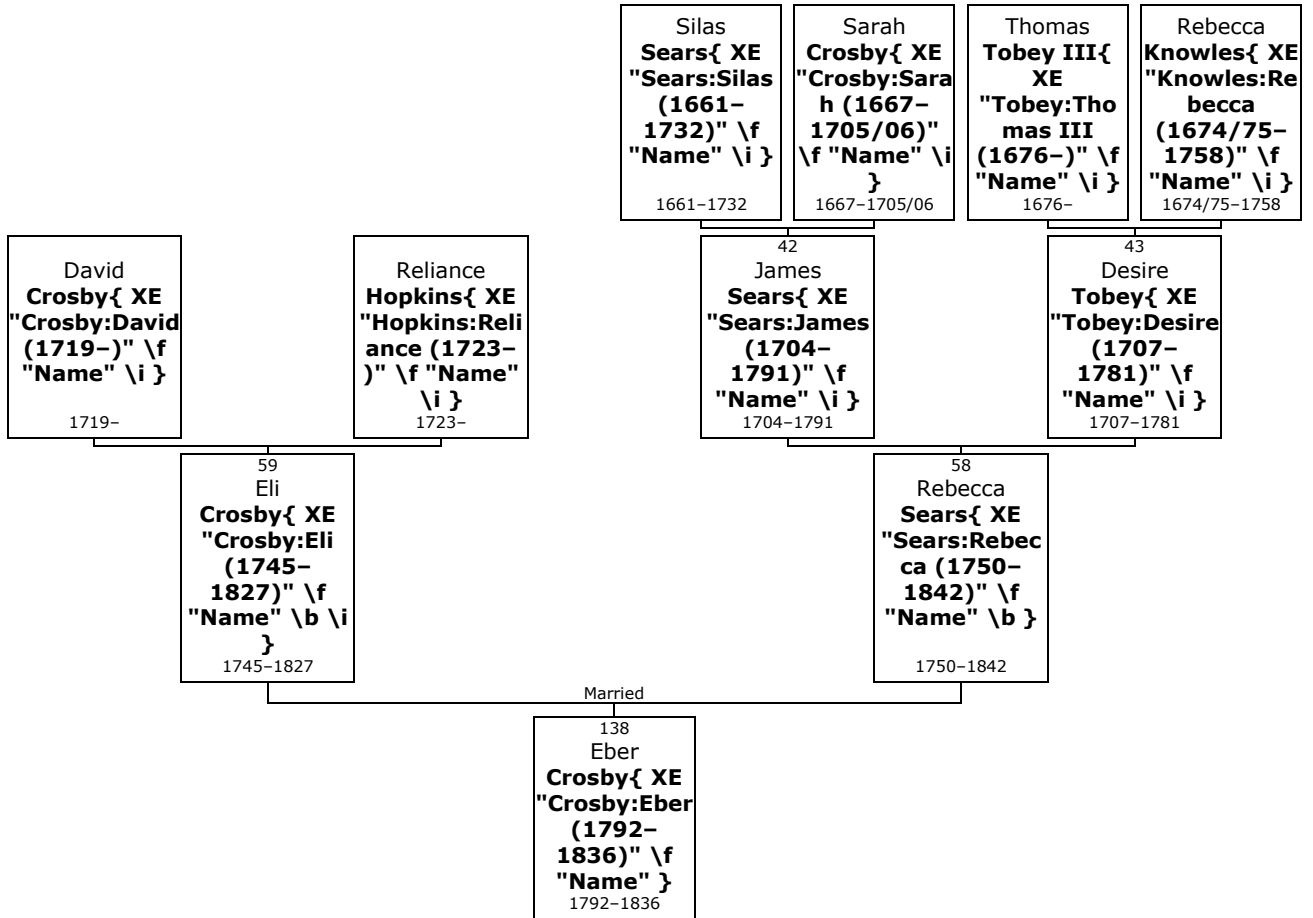

58. **Rebecca³ Sears**{ XE "Sears:Rebecca (1750-1842)" \f "Name" \b } (*James*²) was born in 1750 in perh, Ridgefield, Fairfield, Connecticut, USA{ XE "USA, Connecticut, Fairfield, Ridgefield, perh: :Sears, Rebecca (1750-1842)" \f "Place" }. She was the daughter of James Sears{ XE "Sears:James (1704-1791)" \f "Name" \i } (42) and Desire Tobey{ XE "Tobey:Desire (1707-1781)" \f "Name" \i } (43).

Rebecca died on 20th March 1842, at the age of 92.

!S P May No 302, gr-st RIN[47513]

<https://www.wikitree.com/wiki/Sears-884>

From: Steve Hanson [mailto:shanson@pulmonetic.com] Sent: Friday, February 03, 2006 9:24 AM To: LRSEARS@CAPECOD.NET Subject: Rebecca Sears Hi, I'm searching for Rebecca Sears b. abt. 1758. Don't know place or parents. She married Eli Eastman b. 1749 Fairfield, Fairfield Ct. Have you come across this person? Steve Hanson Email: scheng.1@verizon.net

59. She married **Eli Crosby**{ XE "Crosby:Eli (1745-1827)" \f "Name" \b \i }. They had one son: Eber (1792-1836).

Eli was born in 1745. He was the son of David Crosby{ XE "Crosby:David (1719-)\" \f "Name" \i } and Reliance Hopkins{ XE "Hopkins:Reliance (1723-)\" \f "Name" \i }.

Eli reached 82 years of age and died on 22nd November 1827.

!S P May p.99 gr-st in old Cem'y, one mile north of Milltown, NY. Served in 3d NY Regt in Rev.

Son of Rebecca Sears and Eli Crosby:

+ 138 m I. **Eber⁴ Crosby**{ XE "Crosby:Eber (1792-1836)" \f "Name" } was born in Brewster, Putnam, New York,{ XE "USA, New York, Putnam, Brewster:(41.3973° N, 73.6171° W):Crosby, Eber (1792-1836)" \f "Place" } on 8th September 1792. He died in Southeast{ XE "USA, New York, Putnam, Southeast:(41.4054° N, 73.6001° W):Crosby, Eber (1792-1836)" \f "Place" } on 16th May 1836, at the age of 43.

Family of Comfort Sears and Eunice Crane{ TC "Comfort Sears and Eunice Crane" \I 3 \f C}

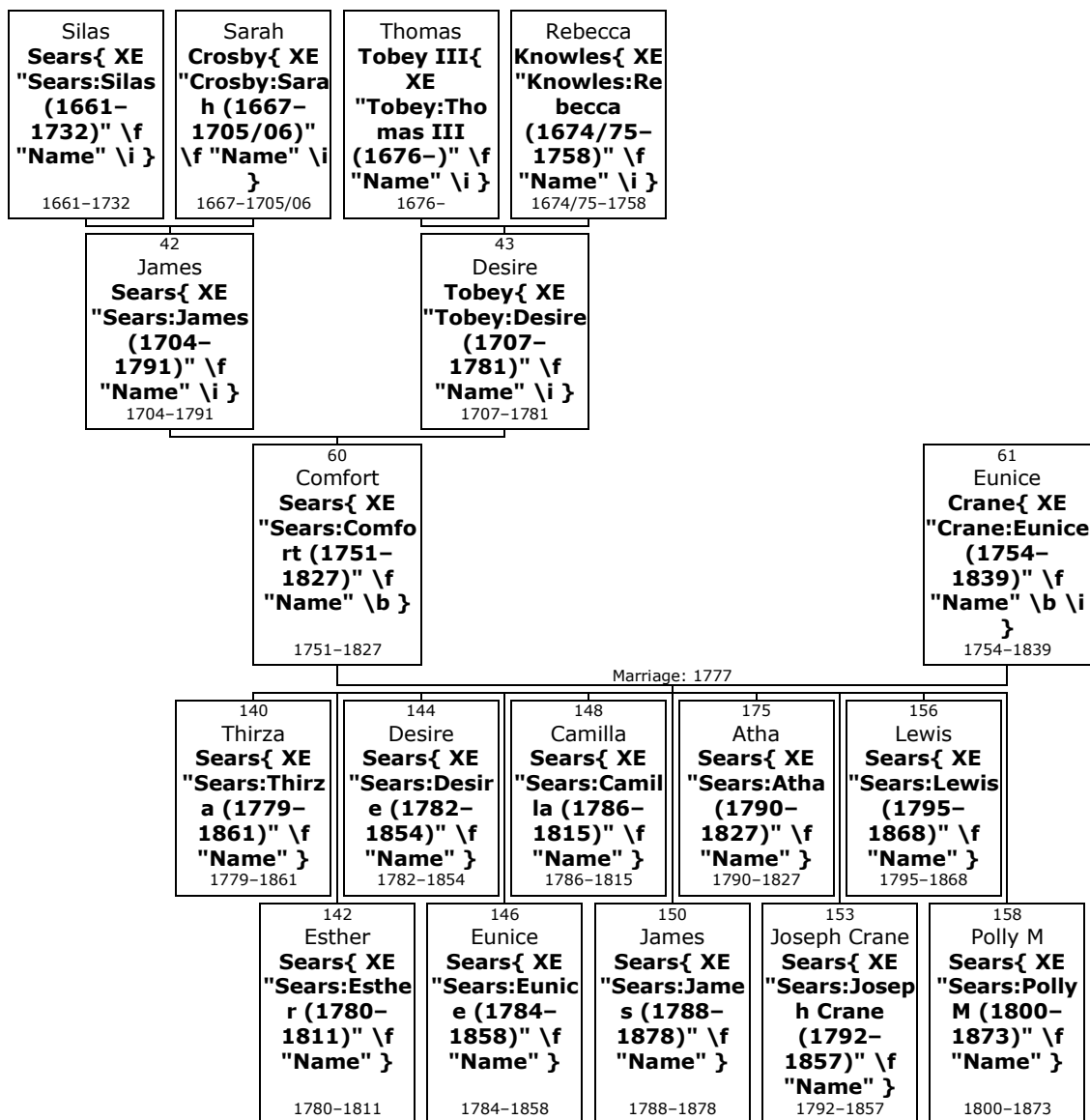

60. **Comfort³ Sears{ XE "Sears:Comfort (1751-1827)" \f "Name" \b }** (*James*²) was born on 20th March 1751, in Ridgefield, Fairfield, Connecticut, USA{ XE "USA, Connecticut, Fairfield, Ridgefield:(41.2815° N, 73.4982° W):Sears, Comfort (1751-1827)" \f "Place" }.^[119, 120, 121, 122, 123-124] He was the son of James

¹¹⁹ Ancestry.com, Connecticut, Deaths and Burials Index, 1650-1934 (Provo, UT, USA, Ancestry.com Operations, Inc., 2011), Ancestry.com.

¹²⁰ Godfrey Memorial Library, comp., American Genealogical-Biographical Index (AGBI) (Provo, UT, USA, Ancestry.com Operations Inc, 1999), Ancestry.com.

¹²¹ Ancestry.com, 1820 United States Federal Census (Provo, UT, USA, Ancestry.com Operations, Inc., 2010), Ancestry.com, 1820 U S Census; Census Place: Ridgefield, Fairfield, Connecticut; Page: 28; NARA Roll: M33_1; Image: 34. [Source citation includes one media item]

¹²² Ancestry.com, 1810 United States Federal Census (Provo, UT, USA, Ancestry.com Operations, Inc., 2010), Ancestry.com, Year: 1810; Census Place: Redding, Fairfield, Connecticut; Roll: 1; Page: 291; Image: 00294; Family History Library Film: 0281229. [Source citation includes one media item]

¹²³ Ancestry.com, Connecticut, Church Record Abstracts, 1630-1920 (Provo, UT, USA, , 2013), Ancestry.com. [Source citation includes one media item]

¹²⁴ Ancestry.com, 1790 United States Federal Census (Provo, UT, USA, Ancestry.com Operations, Inc., 2010), Ancestry.com, Year: 1790; Census Place: Ridgefield, Fairfield, Connecticut; Series: M637; Roll: 1; Page: 296; Image: 302; Family History

Sears{ XE "Sears:James (1704-1791)" \f "Name" \i } (42) and Desire Tobey{ XE "Tobey:Desire (1707-1781)" \f "Name" \i } (43).

Comfort died in Ridgefield{ XE "USA, Connecticut, Fairfield, Ridgefield:(41.2815° N, 73.4982° W):Sears, Comfort (1751-1827)" \f "Place" } on 24th December 1827, at the age of 76.^[119, 123] He was buried in Milltown Cemetery, Southeast, Putnam, New York{ XE "USA, New York, Putnam, Southeast, Milltown Cemetery: :Sears, Comfort (1751-1827)" \f "Place" }.

<https://www.wikitree.com/index.php?title=Sears-876&action=edit>

!S P May No 303, gr-st, Comfort Sears, like his father, was strict in the observance of the Sabbath, and required the same of his children, though he never united with the church.

In February, 1793, his house took fire in the night, and was entirely destroyed. He turned out with only his shirt on, and got out the things; first of all a barrel of pork; in some way he injured his great toe, either by freezing or a bruise, and it was the cause of his death many years after.

He built another house on the same site, which is now occupied by James O.Weed his grandson,and a very good house it still is. It stands on Joe's Hill, now called Federal Hill, Millplain, Fairfield co., CT.

Judge Joseph Crane, his wife's father, was descended from one of the first settlers, and owned a large tract of land in South East, NY, and Joe's Hill was named for him. The line now runs over the range of hills, and that in South East is still called Joe's Hill, while that in Ridgefield is now called Federal Hill.

Eunice Crane was a sister of James Weed's wife Sarah, and of Darius Crane's, (of Hillsdale, MI)grand-father. See ante, No 445.

1790 United States Federal Census

Name: Comfort Sears
Township: Ridgefield
County: Fairfield
State: Connecticut
Number of Free White Males Under 16: 1
Number of Free White Males 16 and Over: 1
Number of Free White Females: 6
Number of Household Members: 8

Church Records:

Name: Comfort Sears
Death Date: 24 Dec 1827
Death Place: Ridgefield, Connecticut, USA

More facts and events for Comfort Sears:

Residence: 1790 Ridgefield, Fairfield, Connecticut{ XE "USA, Connecticut, Fairfield, Ridgefield:(41.2815° N, 73.4982° W):Sears, Comfort (1751-1827)" \f "Place" }^[124]

Residence: 1810 Redding{ XE "USA, Connecticut, Fairfield, Redding:(41.3025° N, 73.3839° W):Sears, Comfort (1751-1827)" \f "Place" }^[122]

Residence: 1820 Ridgefield{ XE "USA, Connecticut, Fairfield, Ridgefield:(41.2815° N, 73.4982° W):Sears, Comfort (1751-1827)" \f "Place" }^[121]

- 61.** At the age of 26, Comfort married **Eunice Crane**{ XE "Crane:Eunice (1754-1839)" \f "Name" \b \i } on Thursday, 18th December 1777, in Ridgefield{ XE "USA, Connecticut, Fairfield, Ridgefield:(41.2815° N, 73.4982° W):Sears, Comfort (1751-1827)" \f "Place" } when she was 23 years old. They had ten children: Thirza (1779-1861), Esther (1780-1811), Desire (1782-1854), Eunice (1784-1858), Camilla (1786-1815), James (1788-1878), Atha (1790-1827), Joseph (1792-1857), Lewis (1795-1868) and Polly (1800-1873).

Eunice was born in perh, Ridgefield,{ XE "USA, Connecticut, Fairfield, Ridgefield, perh: :Crane, Eunice (1754–1839)" \f "Place" } on Wednesday, 20th November 1754. She reached 84 years of age and died on 23rd January 1839. Eunice was buried in Milltown Cemetery, Southeast, Putnam, New York,{ XE "USA, New York, Putnam, Southeast, Milltown Cemetery: :Crane, Eunice (1754–1839)" \f "Place" }.

!another source shows d. 3 Jan 1861

Children of Comfort Sears and Eunice Crane:

- + 140 f I. **Thirza⁴ Sears**{ XE "Sears:Thirza (1779–1861)" \f "Name" } was born in Joe's Hill, Ridgefield,{ XE "USA, Connecticut, Fairfield, Ridgefield, Joe's Hill: :Sears, Thirza (1779–1861)" \f "Place" } on 22nd March 1779.^[125, 126–127] She died in Neversink, Sullivan, New York,{ XE "USA, New York, Sullivan, Neversink:(41.8472° N, 74.6195° W):Sears, Thirza (1779–1861)" \f "Place" } on 3rd January 1861, at the age of 81.^[127]
- + 142 f II. **Esther Sears**{ XE "Sears:Esther (1780–1811)" \f "Name" } was born in Ridgefield{ XE "USA, Connecticut, Fairfield, Ridgefield:(41.2815° N, 73.4982° W):Sears, Esther (1780–1811)" \f "Place" } on 29th July 1780. She died on 10th October 1811, at the age of 31.
- + 144 f III. **Desire Sears**{ XE "Sears:Desire (1782–1854)" \f "Name" } was born in Ridgefield{ XE "USA, Connecticut, Fairfield, Ridgefield:(41.2815° N, 73.4982° W):Sears, Desire (1782–1854)" \f "Place" } on 24th May 1782. She died on 22nd April 1854, at the age of 71.
- + 146 f IV. **Eunice Sears**{ XE "Sears:Eunice (1784–1858)" \f "Name" } was born in Ridgefield{ XE "USA, Connecticut, Fairfield, Ridgefield:(41.2815° N, 73.4982° W):Sears, Eunice (1784–1858)" \f "Place" } on 4th February 1784. She died on 8th July 1858, at the age of 74.
- + 148 f V. **Camilla Sears**{ XE "Sears:Camilla (1786–1815)" \f "Name" } was born in perh, Ridgefield,{ XE "USA, Connecticut, Fairfield, Ridgefield, perh: :Sears, Camilla (1786–1815)" \f "Place" } on 26th April 1786. She died on 9th January 1815, at the age of 28.
- + 150 m VI. **James Sears**{ XE "Sears:James (1788–1878)" \f "Name" } was born in Ridgefield{ XE "USA, Connecticut, Fairfield, Ridgefield:(41.2815° N, 73.4982° W):Sears, James (1788–1878)" \f "Place" } on 10th November 1788.^[128] He died in Seneca Castle, Ontario, New York,{ XE "USA, New York, Ontario, Seneca Castle:(42.8869° N, 77.0964° W):Sears, James (1788–1878)" \f "Place" } on 19th January 1878, at the age of 89.^[128]
- + 175 f VII. **Atha Sears**{ XE "Sears:Atha (1790–1827)" \f "Name" } was born in Ridgefield{ XE "USA, Connecticut, Fairfield, Ridgefield:(41.2815° N, 73.4982° W):Sears, Atha (1790–1827)" \f "Place" } on 18th December 1790. She died on 17th September 1827, at the age of 36.
- + 153 m VIII. **Joseph Crane Sears**{ XE "Sears:Joseph Crane (1792–1857)" \f "Name" } was born in Ridgefield{ XE "USA, Connecticut, Fairfield, Ridgefield:(41.2815° N, 73.4982° W):Sears, Joseph Crane (1792–1857)" \f "Place" } on 18th December 1792.^[129] He died in Millplain{ XE "USA, Connecticut, Millplain: :Sears, Joseph Crane (1792–1857)" \f "Place" } on 29th May 1857, at the age of 64.^[129, 130]
- + 156 m IX. **Lewis Sears**{ XE "Sears:Lewis (1795–1868)" \f "Name" } was born in Ridgefield{ XE "USA, Connecticut, Fairfield, Ridgefield:(41.2815° N, 73.4982° W):Sears, Lewis (1795–1868)" \f "Place" } on 26th June 1795.^[119, 129] He died in Danbury{ XE "USA, Connecticut, Fairfield, Danbury:(41.3948° N, 73.454° W):Sears, Lewis (1795–1868)" \f "Place" } on 10th November 1868, at the age of 73.^[119, 129]

¹²⁵ Samuel P. May, *The Descendants of Richard Sares (Sears) of Yarmouth, Mass. 1638-1888* (Joel Munsell's Sons, Publishers, 1890, Albany, NY), Ray Sears, 2208 Amber RdOklahoma City, OK 73170 / 405/703-0779, Date record was made: 0097/11/06.

¹²⁶ Ancestry.com, New York, State Census, 1855 (Provo, UT, USA, Ancestry.com Operations, Inc., 2013), Ancestry.com.

¹²⁷ "Ancestry Family Tree", Record for Mary (Polly) Matilda Sears. <https://familysearch.org/ark:/61903/1:1:F7WL-GSM>.

¹²⁸ Ancestry.com, U.S., Find A Grave Index, 1600s-Current (Provo, UT, USA, Ancestry.com Operations, Inc., 2012), Ancestry.com, <https://www.findagrave.com/memorial/115562689>.

¹²⁹ Ancestry.com, Connecticut, Hale Cemetery Inscriptions and Newspaper Notices, 1629-1934 (Provo, UT, USA, Ancestry.com Operations, Inc., 2012), Ancestry.com.

¹³⁰ Ancestry.com, Connecticut, Wills and Probate Records, 1609-1999 (Provo, UT, USA, Ancestry.com Operations, Inc., 2015), Ancestry.com, Probate Files Collection, Early to 1880; Author: Connecticut State Library (Hartford, Connecticut); Probate Place: Hartford, Connecticut.

- + 158 f X. **Polly M Sears**{ XE "Sears:Polly M (1800-1873)" \f "Name" } was born in Ridgefield{ XE "USA, Connecticut, Fairfield, Ridgefield:(41.2815° N, 73.4982° W):Sears, Polly M (1800-1873)" \f "Place" } on 26th July 1800.^[131] She died in Patterson, Putnam, New York,{ XE "USA, New York, Putnam, Patterson:(41.5136° N, 73.6067° W):Sears, Polly M (1800-1873)" \f "Place" } on 12th April 1873, at the age of 72.^[131]

¹³¹ "Ancestry Family Tree", Record for Nehemiah Perry. <https://familysearch.org/ark:/61903/4:1:LC88-91Q>.

1st Cousins{ TC "1st Cousins" \ I 2 \ f C }

Family of Bethia Sears and Jacob Goodrich{ TC "Bethia Sears and Jacob Goodrich" \ I 3 \ f C }

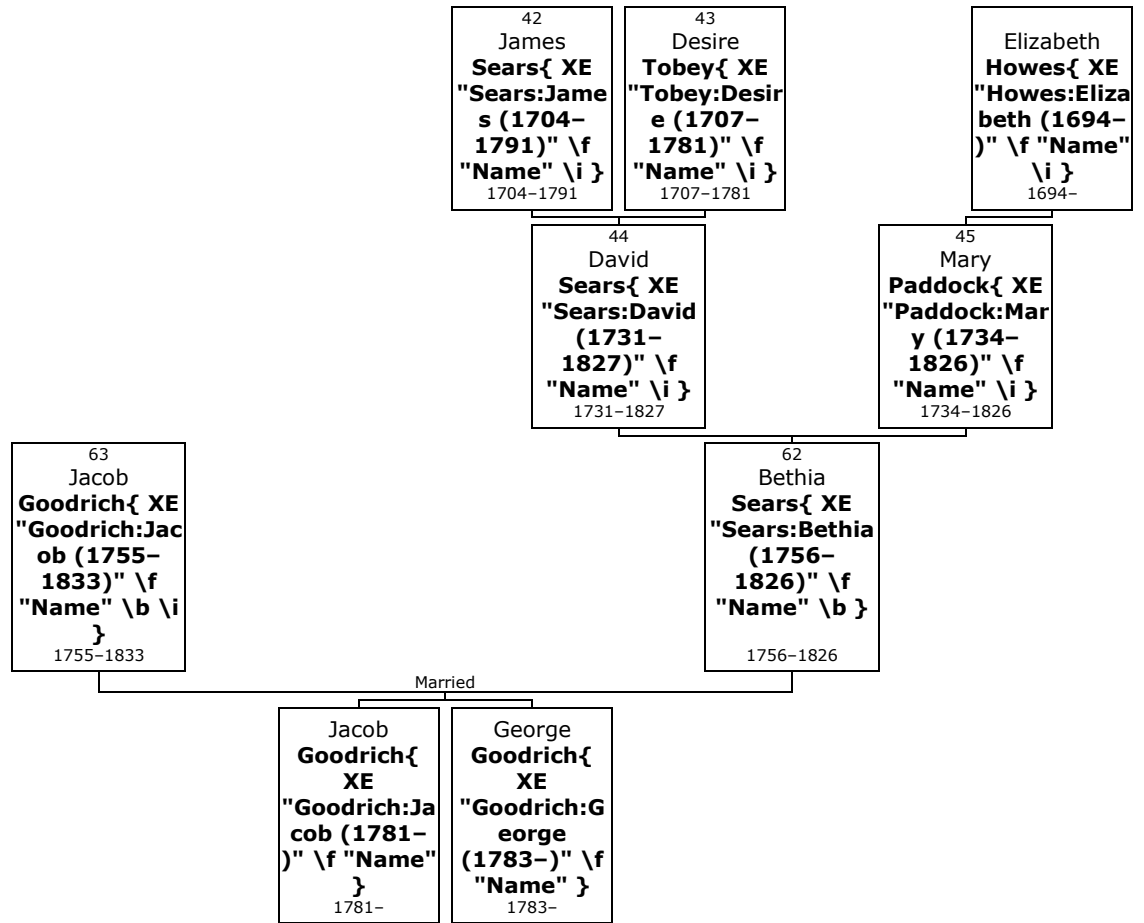

- 62.** **Bethia⁴ Sears**{ XE "Sears: Bethia (1756-1826)" \f "Name" \b } (*David³, James²*) was born in 1756 at perhaps in Lenox, Berkshire, Massachusetts, USA{ XE "USA, Massachusetts, Berkshire, Lenox:(42.3565° N, 73.2849° W):Sears, Bethia (1756-1826)" \f "Place" }. She was the daughter of David Sears{ XE "Sears:David (1731-1827)" \f "Name" \i } (44) and Mary Paddock{ XE "Paddock:Mary (1734-1826)" \f "Name" \i } (45).

Bethia died in 1826 at the age of 70.

had b. 1773 but that is too late, John F Miles shows b. abt 1756

S P May p. 174 No 74

<https://www.wikitree.com/wiki/Sears-4748>

- 63.** She married **Jacob Goodrich**{ XE "Goodrich:Jacob (1755-1833)" \f "Name" \b \i }. They had two sons: Jacob (1781-) and George (1783-).

Jacob was born in Pittsfield{ XE "USA, Massachusetts, Berkshire, Pittsfield:(42.4501° N, 73.2454° W):Goodrich, Jacob (1755-1833)" \f "Place" } on Sunday, 21st September 1755. He reached 77 years of age and died in 1833.

I have been trying for years to further my Goodrich lines. My earliest ancestor is Jacob Goodrich (09\21\1755-after 1833). He served in the Rev. War out of Lenox, MA but lived in Saratoga County, NY by 1810 census and at time of his pension files-1833. His wife was Bethiah. He had two known brothers: Lemuel who died during war and Allen who was buried Ballston Spa in 1835. Thanks. Donna Goodwin, 8299 Village Drive #2, Hayden, Idaho, 83835 208-772-3039

Sons of Bethia Sears and Jacob Goodrich:

- m I. **Jacob⁵ Goodrich**{ XE "Goodrich:Jacob (1781-)" \f "Name" \b } was born in perh, Pittsfield,{ XE "USA, Massachusetts, Berkshire, Pittsfield, perh: :Goodrich, Jacob (1781-

)" \f "Place" } in 1781. He was buried in Monroe, Wisconsin{ XE "USA, Wisconsin, Monroe:(43.9451° N, 90.6196° W):Goodrich, Jacob (1781-)" \f "Place" }.

- m II. **George Goodrich**{ XE "Goodrich:George (1783-)" \f "Name" \b } was born in perh{ XE "USA, Massachusetts, Berkshire, Pittsfield, perh: :Goodrich, George (1783-)" \f "Place" } in 1783.

Family of Philip Sears and Lavina Gunn{ TC "Philip Sears and Lavina Gunn" \I 3 \f C}

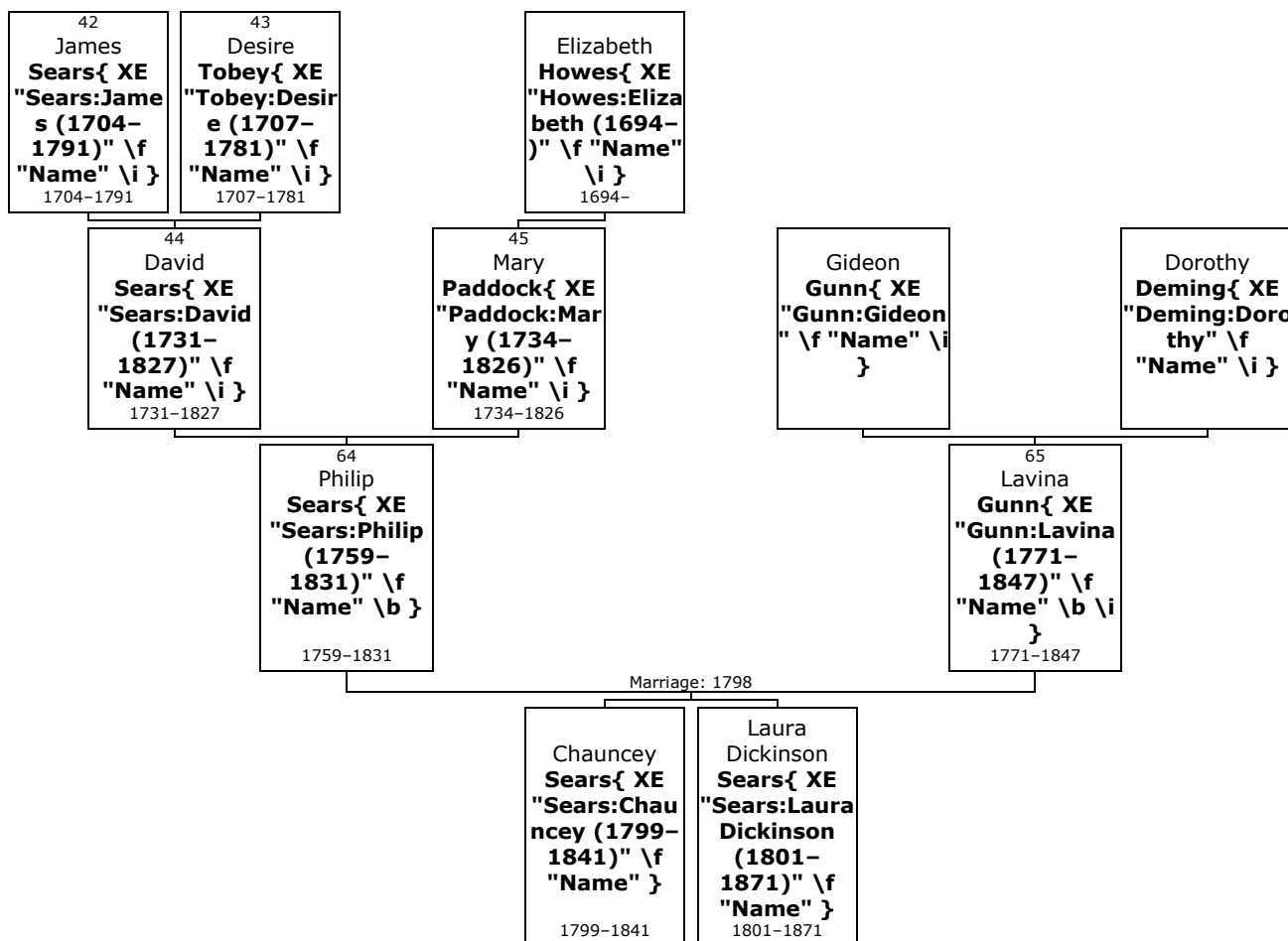

- 64. Corp. Philip⁴ Sears**{ XE "Sears:Philip (1759-1831)" \f "Name" \b } (*David*³, *James*²) was born in 1759 in North East, Dutchess, New York, USA{ XE "USA, New York, Dutchess, North East:(41.9482° N, 73.5462° W):Sears, Philip (1759-1831)" \f "Place" }.^[132, 133] He was the son of David Sears{ XE "Sears:David (1731-1827)" \f "Name" \i } (44) and Mary Paddock{ XE "Paddock:Mary (1734-1826)" \f "Name" \i } (45).

Philip died in Lenox, Berkshire, Massachusetts,{ XE "USA, Massachusetts, Berkshire, Lenox:(42.3565° N, 73.2849° W):Sears, Philip (1759-1831)" \f "Place" } on 17th July 1831, at the age of 72.^[132] He was buried in Lenox{ XE "USA, Massachusetts, Berkshire, Lenox:(42.3565° N, 73.2849° W):Sears, Philip (1759-1831)" \f "Place" }.^[132]

!S.P. May p.271 Philip Sears served in Capt Ezra Whittlesey's Co., 7 to 30 Sep 1777; in Capt Chas. Dibbet's Co. on alarm of 18 Oct 1780, four days' service; and was Corporal in Capt Wm. Well's Co., alarm at Saratoga, 30 Oct to 7 Nov 1781

! 3 Dec 1777. Voted, John Whitlock, Ephraim Smith, David Sears, Philip Sears and Edward Martingale are dangerous to the United States of America, etc. (Town Rec) He was a farmer Birth: 1759, USA Death:

¹³² Ancestry.com, U.S., Find A Grave Index, 1600s-Current (Provo, UT, USA, Ancestry.com Operations, Inc., 2012), Ancestry.com.

¹³³ Ancestry.com, North America, Family Histories, 1500-2000 (Provo, UT, USA, Ancestry.com Operations, Inc., 2016), Ancestry.com, Book Title: The Hamlin Family; a Genealogy of James Hamlin of Barnstable, Massachusetts. [Source citation includes one media item]

Jul. 16, 1831 Lenox Berkshire County Massachusetts, USA Son of David Sears and Mary Paddock; married Lavina Gunn in Lenox in 1798. Philip Sears apparently saw some service in the Revolutionary War, but it is not clear how much time he spent actually fighting. Genealogical research has his rank as corporal, but he is listed in the records of New Lenox Cemetery as captain. He was a farmer. He and Lavina had two children, Chauncy Sears and Laura D. Sears.

!

!Find A Grave Memorial# 47135361

Family links: Parents: David Sears (1731 - 1827) Mary Paddock Sears (1734 - 1826) Spouse: Lavina Sears (____ - 1847) Burial: New Lenox Cemetery Lenox Berkshire County Massachusetts, USA Plot: Row 7, Grave 191 Created by: waldonia Record added: Jan 25, 2010

<https://www.wikitree.com/wiki/Sears-4749>

- 65.** Philip married **Lavina Gunn**{ XE "Gunn:Lavina (1771-1847)" \f "Name" \b \i } on Sunday, 25th November 1798, at pub in Pittsfield{ XE "USA, Massachusetts, Berkshire, Pittsfield:(42.4501° N, 73.2454° W):Sears, Philip (1759-1831)" \f "Place" }.^[132, 133] They had two children: Chauncey (1799-1841) and Laura (1801-1871).

Lavina was born in Pittsfield{ XE "USA, Massachusetts, Berkshire, Pittsfield:(42.4501° N, 73.2454° W):Gunn, Lavina (1771-1847)" \f "Place" } in 1771.^[132] She was the daughter of Gideon Gunn{ XE "Gunn:Gideon" \f "Name" \i } and Dorothy Deming{ XE "Deming:Dorothy" \f "Name" \i }.

Lavina reached 76 years of age and died in New Lenox, Lenox,{ XE "USA, Massachusetts, Berkshire, Lenox, New Lenox: :Gunn, Lavina (1771-1847)" \f "Place" } on 16th March 1847.^[132] She was buried in Lenox{ XE "USA, Massachusetts, Berkshire, Lenox:(42.3565° N, 73.2849° W):Gunn, Lavina (1771-1847)" \f "Place" }.^[132]

John F Miles shows d. New Lenox or Lavinia <http://trees.ancestry.com/owt/person.aspx?pid=83789582>
Birth: unknown Death: Mar. 16, 1847 widow of Capt. Philip Sears, ae 76 years Family links: Spouse: Philip Sears (1759 - 1831)* *Calculated relationship Burial: New Lenox Cemetery Lenox Berkshire County Massachusetts, USA Edit Virtual Cemetery info [?] Created by: Elsie Saar Record added: Aug 10, 2010 Find A Grave Memorial# 56906629

Children of Philip Sears and Lavina Gunn:

- m I. **Chauncey⁵ Sears**{ XE "Sears:Chauncey (1799-1841)" \f "Name" \b } was born in Lenox{ XE "USA, Massachusetts, Berkshire, Lenox:(42.3565° N, 73.2849° W):Sears, Chauncey (1799-1841)" \f "Place" } on 30th June 1799.^[132, 134-135] He was known by the title of Capt.



Chauncey

Chauncey died in Lenox{ XE "USA, Massachusetts, Berkshire, Lenox:(42.3565° N, 73.2849° W):Sears, Chauncey (1799-1841)" \f "Place" } on 10th February 1841, at the age of 41.^[132-134] He was buried in Lenox{ XE "USA, Massachusetts, Berkshire, Lenox:(42.3565° N, 73.2849° W):Sears, Chauncey (1799-1841)" \f "Place" }.^[132]

At the age of 21, Chauncey married **Polly Howland**{ XE "Howland:Polly (1800-1869)" \f "Name" \b \i } on Thursday, 28th December 1820, in Pittsfield{ XE "USA, Massachusetts, Berkshire, Pittsfield:(42.4501° N, 73.2454° W):Sears, Chauncey (1799-1841)" \f "Place" } when she was 20 years old.^[132-135] They had six children: Philip (1823-1862), Horatio (1826-1860), Mary (1828-1883), Henry (1832-), Chauncy (1834-1918) and Lois (1837-1921).

Polly was born in Pittsfield{ XE "USA, Massachusetts, Berkshire, Pittsfield:(42.4501° N, 73.2454° W):Howland, Polly (1800-1869)" \f "Place" } on Sunday, 28th December 1800.^[132-134]

She was the daughter of Joseph Howland{ XE "Howland:Joseph (1774-1798)" \f "Name" \i } and Lois Hamblen{ XE "Hamblen:Lois (1778-)" \f "Name" \i }. Polly reached 68 years of age and died in Lenox{ XE "USA, Massachusetts, Berkshire, Lenox:(42.3565° N, 73.2849° W):Howland, Polly (1800-1869)" \f "Place" } on 8th February 1869.^[132-134] She

¹³⁴ Ancestry.com, U.S., Sons of the American Revolution Membership Applications, 1889-1970 (Provo, UT, USA, Ancestry.com Operations, Inc., 2011), Ancestry.com, Volume: 133.

¹³⁵ Ancestry.com, Massachusetts, Marriage Records, 1840-1915 (Provo, UT, USA, Ancestry.com Operations, Inc., 2013), Ancestry.com, New England Historic Genealogical Society; Boston, Massachusetts; Massachusetts Vital Records, 1911-1915.

was buried in Lenox{ XE "USA, Massachusetts, Berkshire, Lenox:(42.3565° N, 73.2849° W):Howland, Polly (1800–1869)" \f "Place" }.^[132]

John F Miles shows b. Pittsfield Birth: unknown Death: Feb. 8, 1869 wife of Chauncey Sears, ae 68 yrs Burial: New Lenox Cemetery Lenox Berkshire County Massachusetts, USA Edit Virtual Cemetery info [?] Created by: Elsie Saar Record added: Aug 10, 2010 Find A Grave Memorial# 56906927

- f II. **Laura Dickinson Sears**{ XE "Sears:Laura Dickinson (1801–1871)" \f "Name" \b } was born in Lenox{ XE "USA, Massachusetts, Berkshire, Lenox:(42.3565° N, 73.2849° W):Sears, Laura Dickinson (1801–1871)" \f "Place" } on 11th June 1801.^[136, 137] She died in 1871 at the age of 69.^[136] Laura Dickinson was buried at Sugar Grove Cemetery in Sugar Grove{ XE "USA, Illinois, Kane, Sugar Grove:(41.7614° N, 88.4436° W):Sears, Laura Dickinson (1801–1871)" \f "Place" }.^[136]

More facts and events for Laura Dickinson Sears:

Residence: 1870 Illinois{ XE "USA, Illinois:(39.7333° N, 88.5° W):Sears, Laura Dickinson (1801–1871)" \f "Place" }

Residence: 1880 Sugar Grove, Kane, Illinois{ XE "USA, Illinois, Kane, Sugar Grove:(41.7614° N, 88.4436° W):Sears, Laura Dickinson (1801–1871)" \f "Place" }

At the age of 21, Laura Dickinson Sears married **Chauncy Brooks**{ XE "Brooks:Chauncy (1798–1885)" \f "Name" \b \i } on Saturday, 14th September 1822, in Lenox, Berkshire, Massachusetts,{ XE "USA, Massachusetts, Berkshire, Lenox:(42.3565° N, 73.2849° W):Sears, Laura Dickinson (1801–1871)" \f "Place" } when he was 24 years old.^[136–138] They had seven children: Lewis (1823–1893), Laura (1824–1894), Chauncey (1829–1899), Collins (1830–1900), Elisha (1833–1924), Jabez (1835–1905) and Chester (1838–1908).

Chauncy was born in Richmond{ XE "USA, Massachusetts, Berkshire, Richmond:(42.3731° N, 73.3676° W):Brooks, Chauncy (1798–1885)" \f "Place" } on Monday, 29th January 1798.^[136, 138] He was the son of Jabez Brooks{ XE "Brooks:Jabez" \f "Name" \i } and Rhoda --Brooks{ XE "--Brooks:Rhoda" \f "Name" \i }.

He was christened in Richmond{ XE "USA, Massachusetts, Berkshire, Richmond:(42.3731° N, 73.3676° W):Brooks, Chauncy (1798–1885)" \f "Place" }. Chauncy reached 86 years of age and died in Sugar Grove{ XE "USA, Illinois, Kane, Sugar Grove:(41.7614° N, 88.4436° W):Brooks, Chauncy (1798–1885)" \f "Place" } on 14th January 1885.^[136] He was buried at Sugar Grove Cemetery in Sugar Grove{ XE "USA, Illinois, Kane, Sugar Grove:(41.7614° N, 88.4436° W):Brooks, Chauncy (1798–1885)" \f "Place" }.^[136]

1870 census- Sugar Grove Kane, IL w/ wife, Eben W ae 83 (brother?); Collins ae 40; Jane ae 33; Betsey ae 13; Gusta ae 4

¹³⁶ Ancestry.com, U.S., Find A Grave Index, 1600s-Current (Provo, UT, USA, Ancestry.com Operations, Inc., 2012), Ancestry.com, Record for Laura Lavina Paull.
<http://search.ancestry.com/cgi-bin/sse.dll?db=60525&h=34067966&indiv=try>.

¹³⁷ Ancestry.com, Massachusetts, Town and Vital Records, 1620-1988 (Provo, UT, USA, Ancestry.com Operations, Inc., 2011), Ancestry.com.

¹³⁸ Ancestry.com, Massachusetts, Compiled Birth, Marriage, and Death Records, 1700-1850 (Lehi, UT, USA, Ancestry.com Operations, Inc., 2018), Ancestry.com, New England Historic Genealogical Society; Boston, Massachusetts; Vital Records of Richmond, Massachusetts to the Year 1850.
[Source citation includes one media item]

Family of David Sears and Huldah Carr{ TC "David Sears and Huldah Carr" \I 3 \f C}

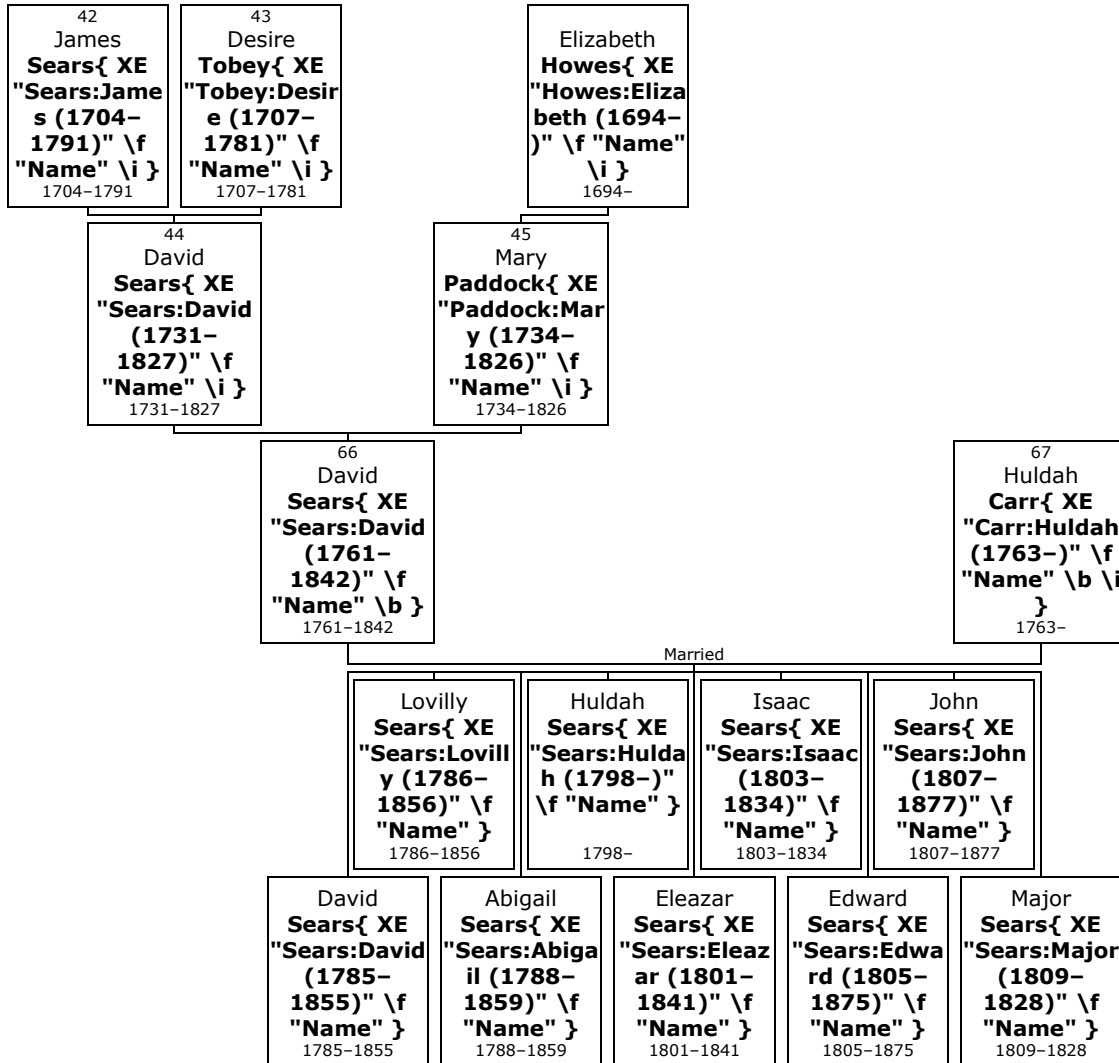

66. **David⁴ Sears**{ XE "Sears:David (1761-1842)" \f "Name" \b } (*David³, James²*) was born in 1761 in perh, New York, USA{ XE "USA, New York, perh: :Sears, David (1761-1842)" \f "Place" }.^[139, 140] He was the son of David Sears{ XE "Sears:David (1731-1827)" \f "Name" \i } (44) and Mary Paddock{ XE "Paddock:Mary (1734-1826)" \f "Name" \i } (45).

David died in Milton, Saratoga,{ XE "USA, New York, Saratoga, Milton:(43.0337° N, 73.8526° W):Sears, David (1761-1842)" \f "Place" } on 19th August 1842, at the age of 81.^[139] He was buried in West Milton, Milton{ XE "USA, New York, Saratoga, Milton, West Milton: :Sears, David (1761-1842)" \f "Place" }.^[139]

!S.P. May p.272 David Sears was in Capt Wm. Ford's Co, Col John Brown's Regt at Stone Arabia, NY, 21 Jul to 27 Oct 1780, and marched to Stillwater in Capt Josiah Yale's Co, 12 Oct 1781, doing 12 days' service.

!https://familysearch.org/pal:/MM9.2.1/3MBP-KXT d.date Not Found on 29 Aug 2019

https://www.wikitree.com/wiki/Sears-4750

Tracy Norstrem Steiner <http://www.facebook.com/profile.php?id=608376646> May 7 at 11:13pm Report Message I saw your post on Facebook with the Sears Family Tree drawn up. Does it contain

¹³⁹ Ancestry.com, U.S., Find A Grave Index, 1600s-Current (Provo, UT, USA, Ancestry.com Operations, Inc., 2012), Ancestry.com.

¹⁴⁰ Hatcher, Patricia Law, Abstract of Graves of Revolutionary Patriots (Provo, UT, USA, Ancestry.com Operations Inc, 1999), Ancestry.com, Abstract of Graves of Revolutionary Patriots; Volume: 4.

67. David married **Huldah Carr**{ XE "Carr:Huldah (1763-)" \f "Name" \b \i } in Lenox, Berkshire, Massachusetts{ XE "USA, Massachusetts, Berkshire, Lenox:(42.3565° N, 73.2849° W):Sears, David (1761-1842)" \f "Place" }. They had nine children: David (1785-1855), Lovilly (1786-1856), Abigail (1788-1859), Huldah (1798-), Eleazar (1801-1841), Isaac (1803-1834), Edward (1805-1875), John (1807-1877) and Major (1809-1828).

Huldah was born at perhaps in Lenox{ XE "USA, Massachusetts, Berkshire, Lenox:(42.3565° N, 73.2849° W):Carr, Huldah (1763-)" \f "Place" } in 1763.

Children of David Sears and Huldah Carr:

- m I. **David⁵ Sears**{ XE "Sears:David (1785-1855)" \f "Name" \b } was born in Lenox{ XE "USA, Massachusetts, Berkshire, Lenox:(42.3565° N, 73.2849° W):Sears, David (1785-1855)" \f "Place" } on 13th June 1785.^[141] He died in 1855 at the age of 69.

More facts and events for David Sears:

Residence: 1790 Washington{ XE "USA, Massachusetts, Berkshire, Washington:(42.3659° N, 73.1162° W):Sears, David (1785-1855)" \f "Place" }^[141]

David married **Clarissa Blinn**{ XE "Blinn:Clarissa (1790-1868)" \f "Name" \b \i } in 1810 in Milton, Saratoga, New York{ XE "USA, New York, Saratoga, Milton:(43.0337° N, 73.8526° W):Sears, David (1785-1855)" \f "Place" }. They had seven children: Orange (1812-1888), Solomon (1815-1872), Huldah (1817-1817), David (1817-1817), Betsy (1818-1839), Major (1822-1855) and David (1826-1883).

Clarissa was born in perh, Milton,{ XE "USA, New York, Saratoga, Milton, perh: :Blinn, Clarissa (1790-1868)" \f "Place" } on Friday, 20th August 1790. She reached 77 years of age and died on 1st February 1868.

- f II. **Lovilly Sears**{ XE "Sears:Lovilly (1786-1856)" \f "Name" \b } was born in Milton, Saratoga, New York,{ XE "USA, New York, Saratoga, Milton:(43.0337° N, 73.8526° W):Sears, Lovilly (1786-1856)" \f "Place" } on 25th October 1786. She died in Nunda, McHenry, Illinois,{ XE "USA, Illinois, McHenry, Nunda:(42.2836° N, 88.2784° W):Sears, Lovilly (1786-1856)" \f "Place" } in 1856 at the age of 69.

Lovilly Sears married **William Hoffman**{ XE "Hoffman:William (1782-)" \f "Name" \b \i } in Auburn, Cayuga, New York{ XE "USA, New York, Cayuga, Auburn:(42.9317° N, 76.5661° W):Sears, Lovilly (1786-1856)" \f "Place" }. They had no known children.

William was born in perh, Milton, Saratoga,{ XE "USA, New York, Saratoga, Milton, perh: :Hoffman, William (1782-)" \f "Place" } in 1782.

- f III. **Abigail Sears**{ XE "Sears:Abigail (1788-1859)" \f "Name" \b } was born in Milton{ XE "USA, New York, Saratoga, Milton:(43.0337° N, 73.8526° W):Sears, Abigail (1788-1859)" \f "Place" } in 1788. She died on 16th March 1859, at the age of 71.

Abigail married **Hezekiah Hoyt**{ XE "Hoyt:Hezekiah" \f "Name" \b \i }.

- f IV. **Huldah Sears**{ XE "Sears:Huldah (1798-)" \f "Name" \b } was born in Milton{ XE "USA, New York, Saratoga, Milton:(43.0337° N, 73.8526° W):Sears, Huldah (1798-)" \f "Place" } on 28th January 1798.

At the age of 17, Huldah married **Alexander Shearer**{ XE "Shearer:Alexander (1786-1845)" \f "Name" \b \i } on Wednesday, 26th April 1815, in Milton{ XE "USA, New York, Saratoga, Milton:(43.0337° N, 73.8526° W):Sears, Huldah (1798-)" \f "Place" } when he was 28 years old. They had seven children: Abigail (1816-), Harriet (1818-), David (1821-1883), Huldah (1822-), Alexander (1825-), Lovilly (1828-) and Mary (1833-).

Alexander was born in Milton{ XE "USA, New York, Saratoga, Milton:(43.0337° N, 73.8526° W):Shearer, Alexander (1786-1845)" \f "Place" } on Friday, 9th June 1786. He reached 59 years of age and died on 29th September 1845.

!S.P. May p.271 He was a farmer and Deacon of Presb Ch.

¹⁴¹ Ancestry.com, 1790 United States Federal Census (Provo, UT, USA, Ancestry.com Operations, Inc., 2010), Ancestry.com, Year: 1790; Census Place: Washington, Berkshire, Massachusetts; Series: M637; Roll: 4; Page: 695; Image: 752; Family History Library Film: 0568144.

- m V. **Eleazar Sears**{ XE "Sears:Eleazar (1801-1841)" \f "Name" \b } was born in Milton, Ulster,{ XE "USA, New York, Ulster, Milton:(41.6597° N, 73.9575° W):Sears, Eleazar (1801-1841)" \f "Place" } on 31st July 1801. He died in Brushy Prairie, Indiana,{ XE "USA, Indiana, Brushy Prairie: :Sears, Eleazar (1801-1841)" \f "Place" } in 1841 at the age of 39. Eleazar was buried in Brushy Chapel Cemetery, Lagrange{ XE "USA, Indiana, Lagrange, Brushy Chapel Cemetery: :Sears, Eleazar (1801-1841)" \f "Place" }.



Eleazar

Eleazar Sears married **Sarah Wheaton**{ XE "Wheaton:Sarah (1806-1846)" \f "Name" \b \i } in Camillus, Onondaga, New York{ XE "USA, New York, Onondaga, Camillus:(43.0392° N, 76.3041° W):Sears, Eleazar (1801-1841)" \f "Place" }.^[139] They had two sons: Ezra (1826-1905) and Isaac (1828-1902).

Sarah was born in perh, Camillus,{ XE "USA, New York, Onondaga, Camillus, perh: :Wheaton, Sarah (1806-1846)" \f "Place" } in 1806.^[139] She reached 40 years of age and died in Lagrange, Indiana,{ XE "USA, Indiana, Lagrange:(41.6421° N, 85.4262° W):Wheaton, Sarah (1806-1846)" \f "Place" } in 1846.^[139] Sarah was buried in Lagrange, Lagrange{ XE "USA, Indiana, Lagrange, Lagrange:(41.6417° N, 85.4167° W):Wheaton, Sarah (1806-1846)" \f "Place" }.^[139]

!Related to Charlotte Wheaton RIN 10749

May, Samuel. [[Space:The Descendants of Richard Sares (Sears) of Yarmouth, Mass., 1638-1888|The Descendants of Richard Sares (Sears) of Yarmouth, Mass., 1638-1888]] [<https://archive.org/stream/descendantsofric00mays#page/414/mode/1up> Page 414] (Joel Munsell's Sons, 1890) No 1589 shows name as Sarah Wheaton.

- m VI. **Isaac Sears**{ XE "Sears:Isaac (1803-1834)" \f "Name" \b } was born in Milton{ XE "USA, New York, Ulster, Milton:(41.6597° N, 73.9575° W):Sears, Isaac (1803-1834)" \f "Place" } in 1803. He died in Ballston Spa, Saratoga,{ XE "USA, New York, Saratoga, Ballston Spa:(43.0009° N, 73.849° W):Sears, Isaac (1803-1834)" \f "Place" } on 17th December 1834, at the age of 31.

Isaac married **Visionia Jones**{ XE "Jones:Visionia" \f "Name" \b \i }.

- m VII. **Edward Sears**{ XE "Sears:Edward (1805-1875)" \f "Name" \b } was born in Milton{ XE "USA, New York, Ulster, Milton:(41.6597° N, 73.9575° W):Sears, Edward (1805-1875)" \f "Place" } in 1805. He died in Kalamazoo, Kalamazoo, Michigan,{ XE "USA, Michigan, Kalamazoo, Kalamazoo:(42.2917° N, 85.5872° W):Sears, Edward (1805-1875)" \f "Place" } in 1875 at the age of 70.

Edward married **Rebecca Hand**{ XE "Hand:Rebecca" \f "Name" \b \i }.

- m VIII. **John Sears**{ XE "Sears:John (1807-1877)" \f "Name" \b } was born in Milton{ XE "USA, New York, Ulster, Milton:(41.6597° N, 73.9575° W):Sears, John (1807-1877)" \f "Place" } in 1807. He died in Kalamazoo, Kalamazoo, Michigan,{ XE "USA, Michigan, Kalamazoo, Kalamazoo:(42.2917° N, 85.5872° W):Sears, John (1807-1877)" \f "Place" } in 1877 at the age of 70.

- m IX. **Major Sears**{ XE "Sears:Major (1809-1828)" \f "Name" \b } was born in Milton{ XE "USA, New York, Ulster, Milton:(41.6597° N, 73.9575° W):Sears, Major (1809-1828)" \f "Place" } in 1809. He died in Saratoga{ XE "USA, New York, Saratoga:(43.1059° N, 73.8677° W):Sears, Major (1809-1828)" \f "Place" } in 1828 at the age of 19.

Isaac Sears{ TC "Isaac Sears" \I 3 \f C}

68. **Isaac⁴ Sears**{ XE "Sears:Isaac (1763-)" \f "Name" \b } (*David³, James²*) was born in 1763 in perh, North East, Dutchess, New York, USA{ XE "USA, New York, Dutchess, North East, perh: :Sears, Isaac (1763-)" \f "Place" }. He was the son of David Sears{ XE "Sears:David (1731-1827)" \f "Name" \i } (44) and Mary Paddock{ XE "Paddock:Mary (1734-1826)" \f "Name" \i } (45).

<http://www.gencircles.com/users/bobandjenny/1/data/7998> Not found on 29 Aug 2019- Isaac Sears 1 SmartMatches Birth: 1763 in Northeast, Dutchess Co, NY Death: Sex: M Father: David Sears Mother: Mary Paddock Spouses & Children Children: Thomas Sears James Sears Charles Andrew Sears Priscilla Stearns (Wife) Marriage: ABT. 1793 Children: Elijah Sears Polly Sears Melissa Sears

S P May p. 173 No 738

<https://www.wikitree.com/wiki/Sears-4751>

Marriages with Priscilla Stearns and an unknown partner are known.

Family of Isaac Sears and Priscilla Stearns{ TC "Isaac Sears and Priscilla Stearns" \I 4 \f C}

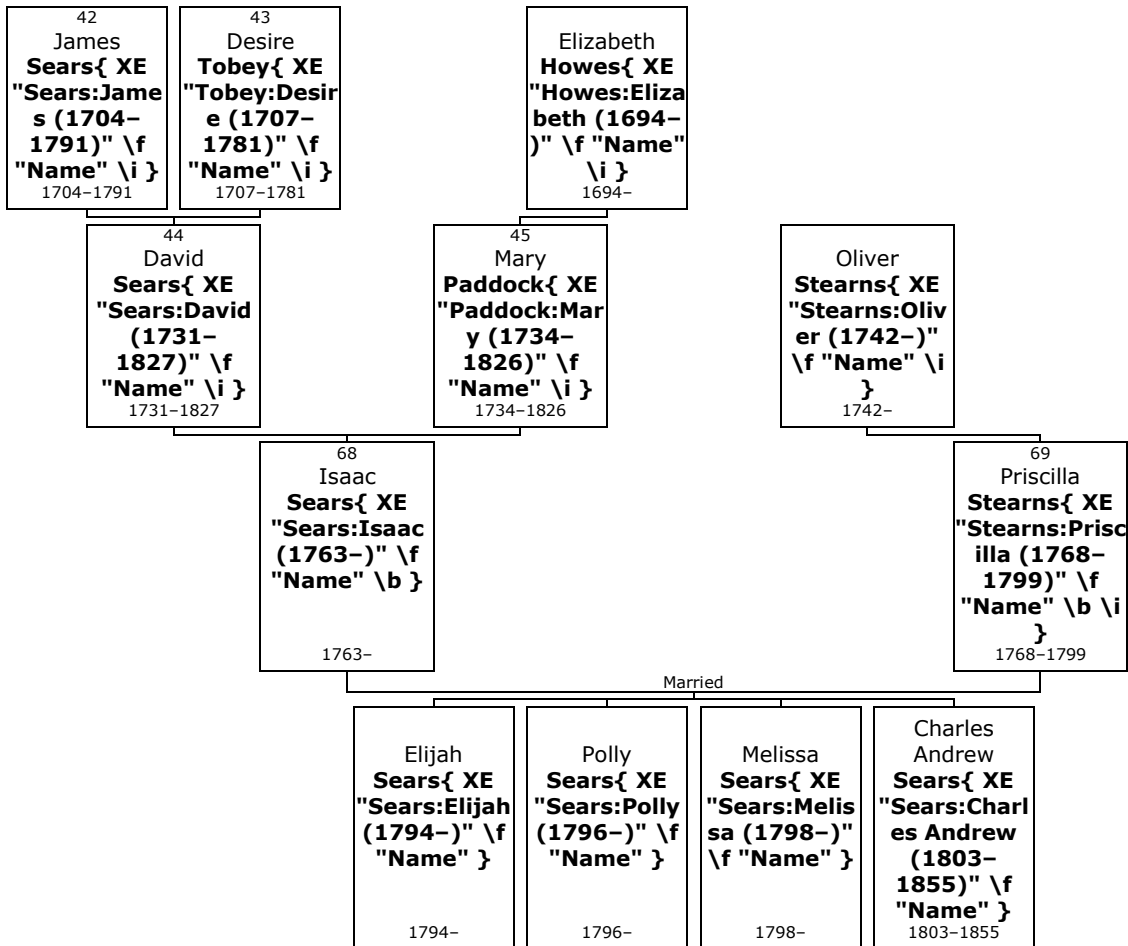

Here are the details about **Isaac Sears**{ XE "Sears:Isaac (1763-)" \f "Name" \b } first marriage, with Priscilla Stearns. You can read more about Isaac on page 89.

- 69.** Isaac Sears married **Priscilla Stearns**{ XE "Stearns:Priscilla (1768-1799)" \f "Name" \b \i }. They had four children: Elijah (1794-), Polly (1796-), Melissa (1798-) and Charles (1803-1855).

Priscilla was born in perh, Mansfield City, Tolland, Connecticut,{ XE "USA, Connecticut, Tolland, Mansfield City, perh: :Stearns, Priscilla (1768-1799)" \f "Place" } in 1768. She was the daughter of Oliver Stearns{ XE "Stearns:Oliver (1742-)" \f "Name" \i }.

Priscilla reached 31 years of age and died in Lenox, Berkshire, Massachusetts,{ XE "USA, Massachusetts, Berkshire, Lenox:(42.3565° N, 73.2849° W):Stearns, Priscilla (1768-1799)" \f "Place" } on 1st May 1799.

Children of Isaac Sears and Priscilla Stearns:

- m I. **Elijah⁵ Sears**{ XE "Sears:Elijah (1794-)" \f "Name" \b } was born in Lenox{ XE "USA, Massachusetts, Berkshire, Lenox:(42.3565° N, 73.2849° W):Sears, Elijah (1794-)" \f "Place" } on 11th May 1794.

Elijah married **Sally Chamberlain**{ XE "Chamberlain:Sally (-1880)" \f "Name" \b \i } on Thursday, 22nd September 1831, in Madrid, St Lawrence, New York{ XE "USA, New York, St Lawrence, Madrid:(44.6287° N, 74.8117° W):Sears, Elijah (1794-)" \f "Place" }. They had three sons: Lyman (1835-1903), Norman and Joel.

Sally was born in Massachusetts{ XE "USA, Massachusetts:(42.1562° N, 71.5662° W):Chamberlain, Sally (-1880)" \f "Place" }. She died in 1880.

- f II. **Polly Sears**{ XE "Sears:Polly (1796-)" \f "Name" \b } was born in Lenox{ XE "USA, Massachusetts, Berkshire, Lenox:(42.3565° N, 73.2849° W):Sears, Polly (1796-)" \f "Place" } on 12th July 1796.
- f III. **Melissa Sears**{ XE "Sears:Melissa (1798-)" \f "Name" \b } was born at perhaps in Lenox{ XE "USA, Massachusetts, Berkshire, Lenox:(42.3565° N, 73.2849° W):Sears, Melissa (1798-)" \f "Place" } in 1798.
- m IV. **Charles Andrew Sears**{ XE "Sears:Charles Andrew (1803-1855)" \f "Name" \b } was born in Lenox{ XE "USA, Massachusetts, Berkshire, Lenox:(42.3565° N, 73.2849° W):Sears, Charles Andrew (1803-1855)" \f "Place" } in 1803. He died in Madrid, St Lawrence, New York,{ XE "USA, New York, St Lawrence, Madrid:(44.6287° N, 74.8117° W):Sears, Charles Andrew (1803-1855)" \f "Place" } on 3rd March 1855, at the age of 52.
- Charles Andrew Sears married **Ursula Abernathy**{ XE "Abernathy:Ursula (1810-1869)" \f "Name" \b \i } in 1829. They had five children: Charlotte (1830-1849), Chauncy (1832-1867), William (1836-1920), Ellen (1838-1921) and Andrew (1844-1907).
- Ursula was born in Madrid{ XE "USA, New York, St Lawrence, Madrid:(44.6287° N, 74.8117° W):Abernathy, Ursula (1810-1869)" \f "Place" } on Monday, 4th June 1810. She reached 59 years of age and died in Madrid{ XE "USA, New York, St Lawrence, Madrid:(44.6287° N, 74.8117° W):Abernathy, Ursula (1810-1869)" \f "Place" } on 10th October 1869.

Isaac Sears{ TC "Isaac Sears" \I 4 \f C}

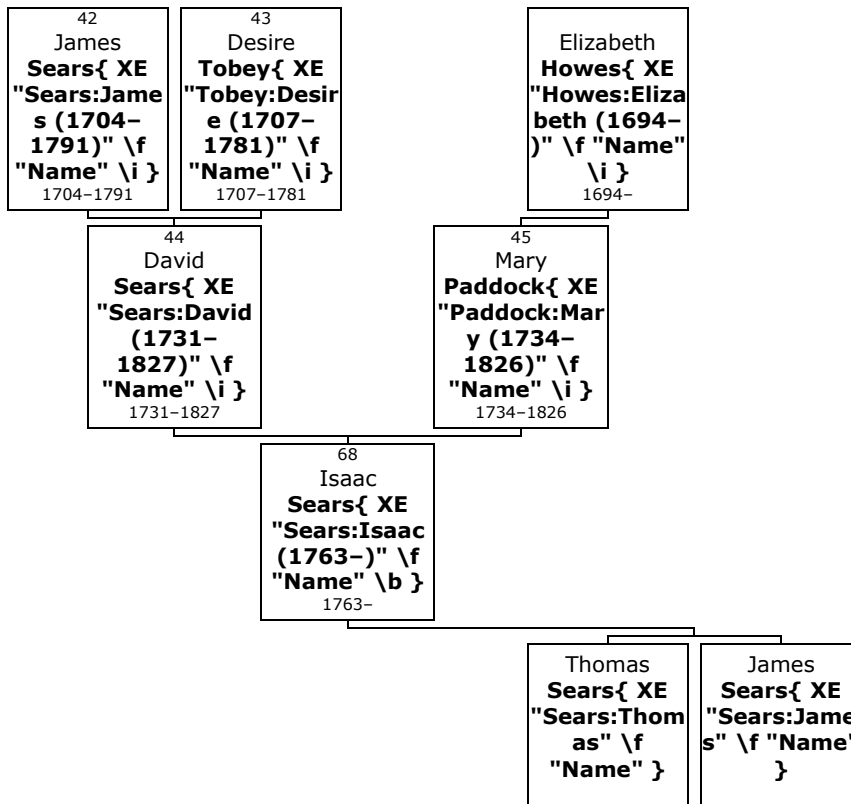

Here are the details about **Isaac Sears**{ XE "Sears:Isaac (1763-)" \f "Name" \b } second marriage, with an unknown partner. You can read more about Isaac on page 89.

Sons of Isaac Sears:

- m I. **Thomas⁵ Sears**{ XE "Sears:Thomas" \f "Name" \b }.
- m II. **James Sears**{ XE "Sears:James" \f "Name" \b }.

Calvin Sears{ TC "Calvin Sears" \I 3 \f C}

70. Calvin⁴ Sears{ XE "Sears:Calvin (1769–1859)" \f "Name" \b } (*David³, James²*) was born in 1769 in Lenox, Berkshire, Massachusetts, USA{ XE "USA, Massachusetts, Berkshire, Lenox:(42.3565° N, 73.2849° W):Sears, Calvin (1769–1859)" \f "Place" }.^[142] He was the son of David Sears{ XE "Sears:David (1731–1827)" \f "Name" \i } (44) and Mary Paddock{ XE "Paddock:Mary (1734–1826)" \f "Name" \i } (45).

Calvin died in Lenox{ XE "USA, Massachusetts, Berkshire, Lenox:(42.3565° N, 73.2849° W):Sears, Calvin (1769–1859)" \f "Place" } on 6th March 1859, at the age of 90.^[142]

!BIRTH-FATHER-SPOUSE-CHILDREN-DEATH-BIOGRAPHY: Samuel Pearce May, THE DESCENDANTS OF RICHARD SARES(SEARS) OF YARMOUTH,MASS; 1638-1888; Albany, Joel Munsell's Sons, 1890; pp 274; NEHGS Library, Boston, MA. Calvin Sears kept tavern in Worthington, MA

!

!BIRTH-MARRIAGE-DEATH-BIOGRAPHY: Letter from RAdm Scott L Sears, Newport, RI, to Ray Sears in Duncan, OK; 1769-1994; Letter dtd 31 Mar 1994; ; copy in poss of Ray Sears, Duncan, OK. Mary Hubby's will lists four children by her and Calvin.

<https://www.wikitree.com/wiki/Sears-1472>

Marriages with Mary Hubby and Isabell --Sears (Page 94) are known.

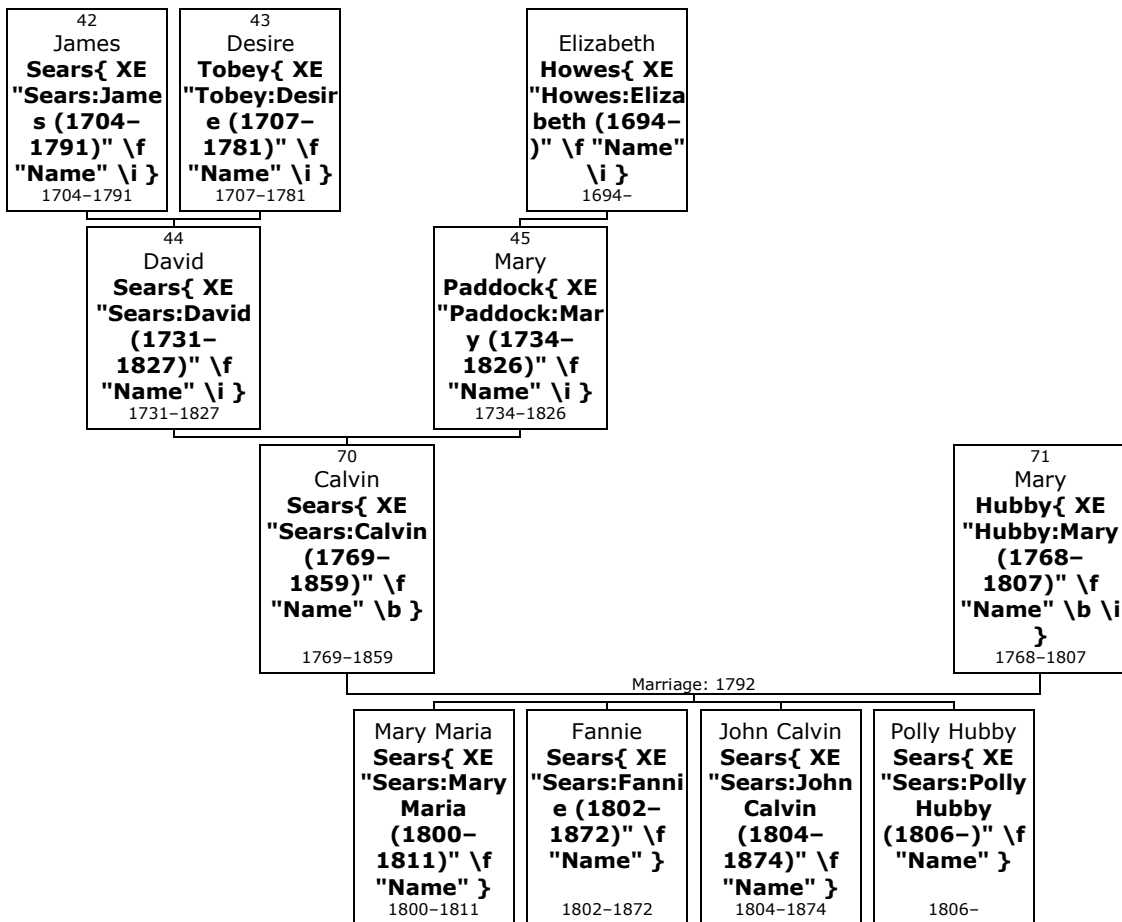
Family of Calvin Sears and Mary Hubby{ TC "Calvin Sears and Mary Hubby" \I 4 \f C}

Here are the details about **Calvin Sears{ XE "Sears:Calvin (1769–1859)" \f "Name" \b }** first marriage, with Mary Hubby. You can read more about Calvin on page 92.

71. Calvin Sears married **Mary Hubby{ XE "Hubby:Mary (1768–1807)" \f "Name" \b \i }** on Tuesday, 25th December 1792, in pub, Lenox{ XE "USA, Massachusetts, Berkshire, Lenox, pub: :Sears, Calvin (1769–

¹⁴² Ancestry.com, Massachusetts, Death Records, 1841-1915 (Provo, UT, USA, Ancestry.com Operations, Inc., 2013), Ancestry.com.

[Source citation includes one media item]

1859)" \f "Place" }. They had four children: Mary (1800–1811), Fannie (1802–1872), John (1804–1874) and Polly (1806–).

Mary was born in Pittsfield{ XE "USA, Massachusetts, Berkshire, Pittsfield:(42.4501° N, 73.2454° W):Hubby, Mary (1768–1807)" \f "Place" } in 1768. She reached 39 years of age and died in Pittsfield{ XE "USA, Massachusetts, Berkshire, Pittsfield:(42.4501° N, 73.2454° W):Hubby, Mary (1768–1807)" \f "Place" } on 16th October 1807.

!BIRTH-MARRIAGE-DEATH-BIOGRAPHY: Letter from RAdm Scott L Sears, Newport, RI, to Ray Sears in Duncan, OK; 1769-1994; Letter dtd 31 Mar 1994; ; copy in poss of Ray Sears, Duncan, OK. Mary Hubby's will was probated 3 Nov 1807, at which time Calvin was appointed guardian of Mary Maria, Fanny, John Calvin and Polly Hubby.

Children of Calvin Sears and Mary Hubby:

- f I. **Mary Maria⁵ Sears**{ XE "Sears:Mary Maria (1800–1811)" \f "Name" \b } was born in Lenox{ XE "USA, Massachusetts, Berkshire, Lenox:(42.3565° N, 73.2849° W):Sears, Mary Maria (1800–1811)" \f "Place" } on 14th May 1800. She died in Pittsfield{ XE "USA, Massachusetts, Berkshire, Pittsfield:(42.4501° N, 73.2454° W):Sears, Mary Maria (1800–1811)" \f "Place" } on 25th December 1811, at the age of 11.
- f II. **Fannie Sears**{ XE "Sears:Fannie (1802–1872)" \f "Name" \b } was born in Lenox{ XE "USA, Massachusetts, Berkshire, Lenox:(42.3565° N, 73.2849° W):Sears, Fannie (1802–1872)" \f "Place" } on 30th March 1802. She died in 1872 at the age of 69.
- At the age of 21, Fannie married **John Henry Phelps**{ XE "Phelps:John Henry (1792–1874)" \f "Name" \b \i } on Tuesday, 15th July 1823, in Lenox{ XE "USA, Massachusetts, Berkshire, Lenox:(42.3565° N, 73.2849° W):Sears, Fannie (1802–1872)" \f "Place" } when he was 31 years old. They had no known children.
- John Henry was born in Lenox{ XE "USA, Massachusetts, Berkshire, Lenox:(42.3565° N, 73.2849° W):Phelps, John Henry (1792–1874)" \f "Place" } on Thursday, 19th April 1792. He reached 82 years of age and died in Wadsworth, Medina, Ohio,{ XE "USA, Ohio, Medina, Wadsworth:(41.0256° N, 81.7299° W):Phelps, John Henry (1792–1874)" \f "Place" } on 6th June 1874.
- !MARRIAGE: Letter from RAdm Scott L Sears, Newport, RI, to Ray Sears in Duncan, OK; 1769-1994; Letter dtd 31 Mar 1994; ; copy in poss of Ray Sears, Duncan, OK.
!BIRTH-DEATH: Letter from Dallas Phelps, Camden, SC, to Ray Sears; 1792-1899; Letter dtd 10 Jun 1993; ; copy in poss of Ray Sears; The Phelps Family of America & Their English Ancestors, 1899, Pittsfield, MA, by O S Phelps & A T Servin.
!SPOUSE-MARRIAGE:S P May p 274 Showed his name as John A Phelps.
- m III. **John Calvin Sears**{ XE "Sears:John Calvin (1804–1874)" \f "Name" \b } was born in Lenox{ XE "USA, Massachusetts, Berkshire, Lenox:(42.3565° N, 73.2849° W):Sears, John Calvin (1804–1874)" \f "Place" } on 6th August 1804. He died in 1874 at the age of 69.
- John Calvin Sears married **Eunice P --Sears**{ XE "--Sears:Eunice P (1804–)" \f "Name" \b \i }. They had three children: Earl (1830–1906), Schuyler (1832–) and Martha (1833–).
- Eunice P was born in Connecticut{ XE "USA, Connecticut:(41.5735° N, 72.7383° W):--Sears, Eunice P (1804–)" \f "Place" } in 1804.
- 1850 census with husband and two children
- f IV. **Polly Hubby Sears**{ XE "Sears:Polly Hubby (1806–)" \f "Name" \b } was born at perhaps in Lenox{ XE "USA, Massachusetts, Berkshire, Lenox:(42.3565° N, 73.2849° W):Sears, Polly Hubby (1806–)" \f "Place" } in 1806.

Family of Calvin Sears and Isabell --Sears{ TC "Calvin Sears and Isabell --Sears" \l 4 \f C}

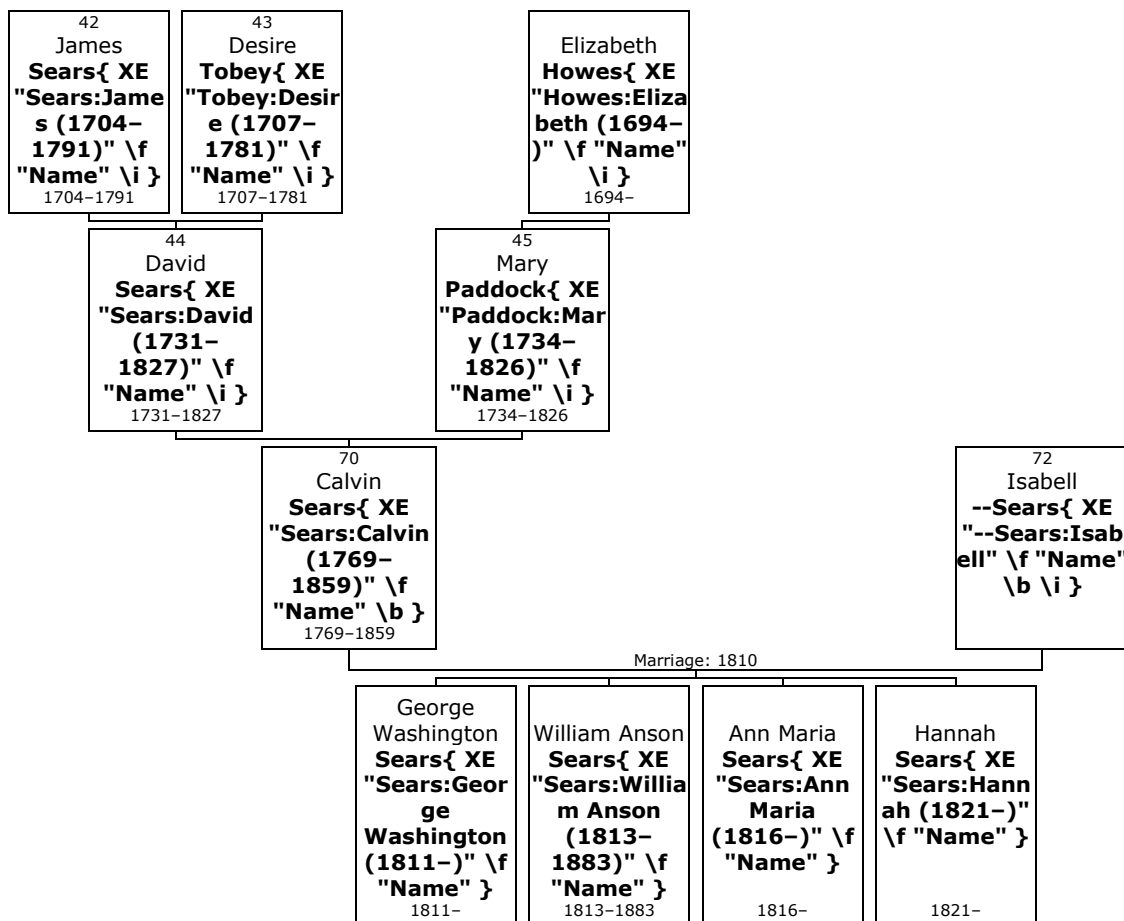

Here are the details about **Calvin Sears**{ XE "Sears:Calvin (1769-1859)" \f "Name" \b } second marriage, with **Isabell --Sears**. You can read more about Calvin on page 92.

- 72.** Calvin Sears married **Isabell --Sears**{ XE "--Sears:Isabell" \f "Name" \b \i } in 1810. Prob Pittsfield. They had four children: George (1811-), William (1813-1883), Ann (1816-) and Hannah (1821-).

!BIRTH-MARRIAGE-DEATH-BIOGRAPHY: Letter from RAdmScott L Sears, Newport, RI, to Ray Sears in Duncan, OK; 1769-1994; Letter dtd 31 Mar 1994; ; copy in poss of Ray Sears, Duncan, OK.

Children of Calvin Sears and Isabell --Sears:

- m I. **George Washington⁵ Sears**{ XE "Sears:George Washington (1811-)" \f "Name" \b } was born in Pittsfield{ XE "USA, Massachusetts, Berkshire, Pittsfield:(42.4501° N, 73.2454° W):Sears, George Washington (1811-)" \f "Place" } on 7th July 1811.^[143, 144]

George Washington married **Sarah Brown**{ XE "Brown:Sarah (1815-)" \f "Name" \b \i } on Saturday, 22nd October 1836, in Pittsfield{ XE "USA, Massachusetts, Berkshire, Pittsfield:(42.4501° N, 73.2454° W):Sears, George Washington (1811-)" \f "Place" }.^[143, 144] They had three children: (unknown given name) (1839-1839), Henry (1840-) and George (1842-1875).

Sarah was born in Pittsfield{ XE "USA, Massachusetts, Berkshire, Pittsfield:(42.4501° N, 73.2454° W):Brown, Sarah (1815-)" \f "Place" } in 1815.^[143]

¹⁴³ Ancestry.com, Massachusetts, Death Records, 1841-1915 (Provo, UT, USA, Ancestry.com Operations, Inc., 2013), Ancestry.com, New England Historic Genealogical Society; Boston, Massachusetts; Massachusetts Vital Records, 1840-1911. Record for George W Sears. <http://search.ancestry.com/cgi-bin/sse.dll?db=2101&h=6969566&indiv=try>.

¹⁴⁴ Ancestry.com, Massachusetts, Town and Vital Records, 1620-1988 (Provo, UT, USA, Ancestry.com Operations, Inc., 2011), Ancestry.com, Record for George Washington Sears. <http://search.ancestry.com/cgi-bin/sse.dll?db=2495&h=8039459&indiv=try>.

!BIRTH-MARRIAGE-DEATH-BIOGRAPHY: Letter from RAdm Scott L Sears, Newport, RI, to Ray Sears in Duncan, OK; 1769-1994; Letter dtd 31 Mar 1994; ; copy in poss of Ray Sears, Duncan, OK; In 1868, listed as a nurse in Beaver, MA. In 1887 was a widow and lived on Middle Lenox Rd (by railroad) in Lenox, MA.

- m II. **William Anson Sears**{ XE "Sears:William Anson (1813-1883)" \f "Name" \b } was born in Worthington, Hampshire,{ XE "USA, Massachusetts, Hampshire, Worthington:(42.41° N, 72.9356° W):Sears, William Anson (1813-1883)" \f "Place" } on 12th June 1813. He died in 1883 at the age of 69.

William Anson Sears married **(unknown given name) Clark**{ XE "Clark: (1817-)" \f "Name" \b \i }. They had no known children.

(unknown given name) was born in Washington{ XE "USA, Washington:(47.2667° N, 119.125° W):Clark, (1817-)" \f "Place" } in 1817.
- f III. **Ann Maria Sears**{ XE "Sears:Ann Maria (1816-)" \f "Name" \b } was born in Worthington{ XE "USA, Massachusetts, Hampshire, Worthington:(42.41° N, 72.9356° W):Sears, Ann Maria (1816-)" \f "Place" } on 19th September 1816.
- f IV. **Hannah Sears**{ XE "Sears:Hannah (1821-)" \f "Name" \b } was born in Lenox, Berkshire,{ XE "USA, Massachusetts, Berkshire, Lenox:(42.3565° N, 73.2849° W):Sears, Hannah (1821-)" \f "Place" } on 1st June 1821.

Family of Luther Sears and Anna Foster{ TC "Luther Sears and Anna Foster" \I 3 \f C}

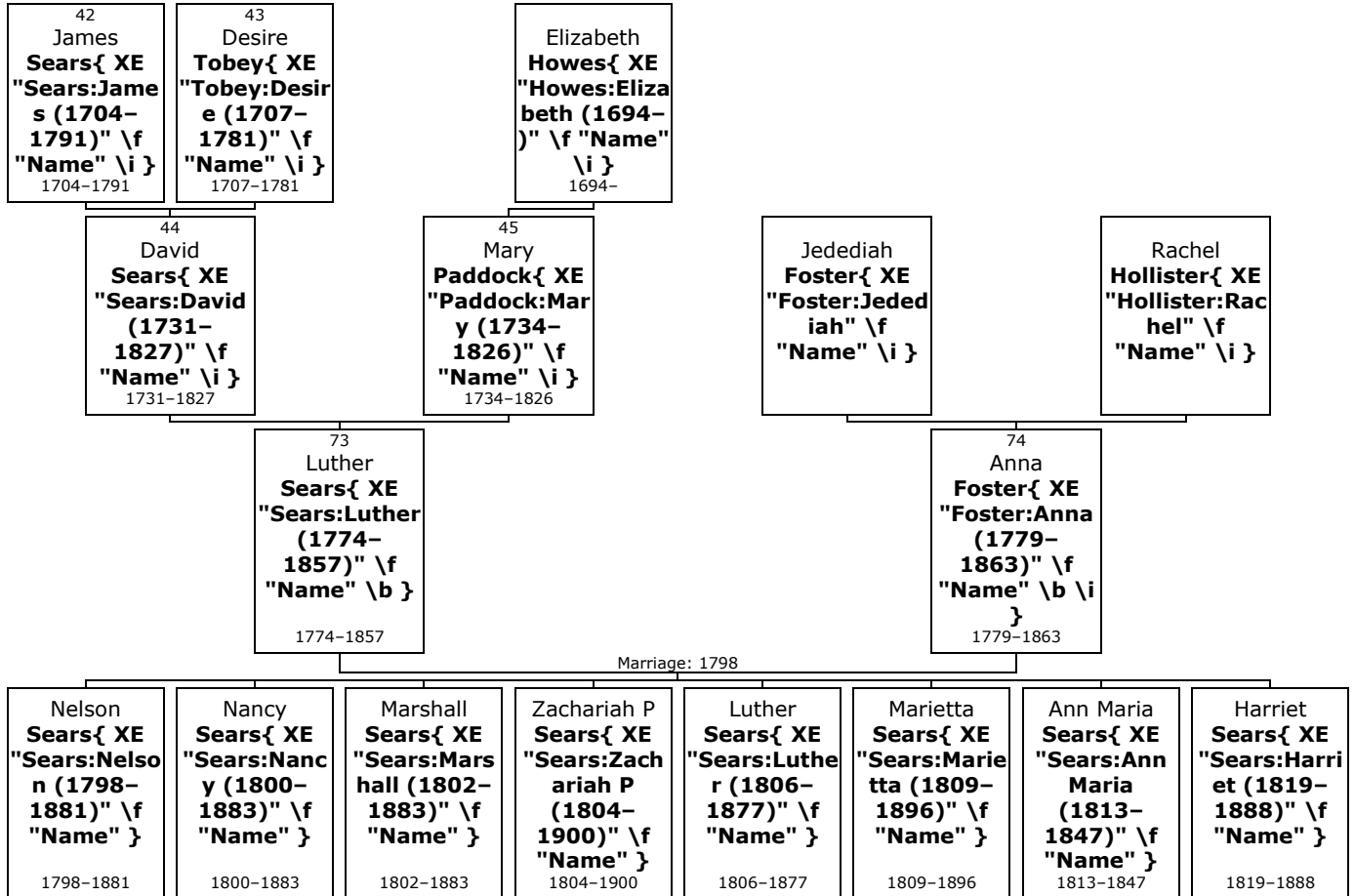

73. Luther⁴ Sears{ XE "Sears:Luther (1774-1857)" \f "Name" \b } (*David³, James²*) was born on Wednesday, 28th September 1774, in Lenox, Berkshire, Massachusetts, USA{ XE "USA, Massachusetts, Berkshire, Lenox:(42.3565° N, 73.2849° W):Sears, Luther (1774-1857)" \f "Place" }.^[145, 146] He was the

¹⁴⁵ Ancestry.com, U.S., Find A Grave Index, 1600s-Current (Provo, UT, USA, Ancestry.com Operations, Inc., 2012), <https://www.findagrave.com/memorial/95327602>.

son of David Sears{ XE "Sears:David (1731-1827)" \f "Name" \i } (44) and Mary Paddock{ XE "Paddock:Mary (1734-1826)" \f "Name" \i } (45).

Luther died in Volney, Oswego, New York,{ XE "USA, New York, Oswego, Volney:(43.3428° N, 76.3581° W):Sears, Luther (1774-1857)" \f "Place" } in July 1857 at the age of 82.^[145] He was buried in Fulton{ XE "USA, New York, Oswego, Fulton:(43.3229° N, 76.4172° W):Sears, Luther (1774-1857)" \f "Place" }.^[145]

Judith Allen family group sheet - info from First Part Gazetteer - Berkshire co, Mass. by Hamilton Child, p. 216

S P May p 173

<https://www.wikitree.com/wiki/Sears-4753>

- 74.** At the age of 23, Luther married **Anna Foster**{ XE "Foster:Anna (1779-1863)" \f "Name" \b \i } on Monday, 5th February 1798, at By Eldad Lewis in Lenox, Berkshire, Massachusetts,{ XE "USA, Massachusetts, Berkshire, Lenox:(42.3565° N, 73.2849° W):Sears, Luther (1774-1857)" \f "Place" } when she was 18 years old.^[146, 147-148] They had eight children: Nelson (1798-1881), Nancy (1800-1883), Marshall (1802-1883), Zachariah (1804-1900), Luther (1806-1877), Marietta (1809-1896), Ann (1813-1847) and Harriet (1819-1888).

Anna was born in Lenox{ XE "USA, Massachusetts, Berkshire, Lenox:(42.3565° N, 73.2849° W):Foster, Anna (1779-1863)" \f "Place" } on Thursday, 25th March 1779.^[148] She was the daughter of Jedediah Foster{ XE "Foster:Jedediah" \f "Name" \i } and Rachel Hollister{ XE "Hollister:Rachel" \f "Name" \i }.

Anna reached 84 years of age and died in Volney, Oswego, New York,{ XE "USA, New York, Oswego, Volney:(43.3428° N, 76.3581° W):Foster, Anna (1779-1863)" \f "Place" } on 30th May 1863.^[148] She was buried in Fulton{ XE "USA, New York, Oswego, Fulton:(43.3229° N, 76.4172° W):Foster, Anna (1779-1863)" \f "Place" }.^[148]

Children of Luther Sears and Anna Foster:

- m I. **Nelson⁵ Sears**{ XE "Sears:Nelson (1798-1881)" \f "Name" \b } was born in Lenox{ XE "USA, Massachusetts, Berkshire, Lenox:(42.3565° N, 73.2849° W):Sears, Nelson (1798-1881)" \f "Place" } on 12th August 1798.^[147, 149, 150-151] He died in Oswego{ XE "USA, New York, Oswego:(43.2462° N, 76.139° W):Sears, Nelson (1798-1881)" \f "Place" } on 8th June 1881, at the age of 82.^[149] Nelson was buried in Volney, Oswego County{ XE "USA, New York, Oswego County, Volney:(43.3428° N, 76.3581° W):Sears, Nelson (1798-1881)" \f "Place" }.^[149]

More facts and events for Nelson Sears:

Residence: 1840 Volney, Oswego{ XE "USA, New York, Oswego, Volney:(43.3428° N, 76.3581° W):Sears, Nelson (1798-1881)" \f "Place" }.^[151]

Residence: 1855 Volney{ XE "USA, New York, Oswego, Volney:(43.3428° N, 76.3581° W):Sears, Nelson (1798-1881)" \f "Place" }.^[150]
Relation to Head of House: Head

Nelson married **Amanda Cole**{ XE "Cole:Amanda (1799-1871)" \f "Name" \b \i } on Tuesday, 18th January 1820, at By Rev Shepard in Lenox, Berkshire, Massachusetts{ XE

¹⁴⁶ Ancestry.com, Massachusetts, Town and Vital Records, 1620-1988 (Provo, UT, USA, Ancestry.com Operations, Inc., 2011), Ancestry.com, <https://search.ancestry.com/cgi-bin/sse.dll?db=2495&h=6635835&indiv=try>. [Source citation includes one media item]

¹⁴⁷ Ancestry.com, Massachusetts, Town and Vital Records, 1620-1988 (Provo, UT, USA, Ancestry.com Operations, Inc., 2011), Ancestry.com. [Source citation includes one media item]

¹⁴⁸ Ancestry.com, U.S., Find A Grave Index, 1600s-Current (Provo, UT, USA, Ancestry.com Operations, Inc., 2012), <https://www.findagrave.com/memorial/95327613>.

¹⁴⁹ Ancestry.com, U.S., Find A Grave Index, 1600s-Current (Provo, UT, USA, Ancestry.com Operations, Inc., 2012), Ancestry.com.

¹⁵⁰ Ancestry.com, New York, State Census, 1855 (Provo, UT, USA, Ancestry.com Operations, Inc., 2013), Ancestry.com.

¹⁵¹ Ancestry.com, 1840 United States Federal Census (Provo, UT, USA, Ancestry.com Operations, Inc., 2010), Ancestry.com, Year: 1840; Census Place: Volney, Oswego, New York; Roll: 325; Page: 36; Family History Library Film: 0017202.

"USA, Massachusetts, Berkshire, Lenox:(42.3565° N, 73.2849° W):Sears, Nelson (1798–1881)" \f "Place" }.^[147, 149, 150] They had five children: Ann (ca.1821–1893), Melissa (1823–), Nancy (1825–1905), Harriet (1827–1922) and James (ca.1829–1903). Amanda was born in 1799.^[149, 150] Of Lenox. She reached 72 years of age and died in Oswego{ XE "USA, New York, Oswego:(43.2462° N, 76.139° W):Cole, Amanda (1799–1871)" \f "Place" } on 3rd June 1871.^[149] Amanda was buried in Volney, Oswego County{ XE "USA, New York, Oswego County, Volney:(43.3428° N, 76.3581° W):Cole, Amanda (1799–1871)" \f "Place" }.^[149]

- f II. **Nancy Sears**{ XE "Sears:Nancy (1800–1883)" \f "Name" \b } was born in Lenox{ XE "USA, Massachusetts, Berkshire, Lenox:(42.3565° N, 73.2849° W):Sears, Nancy (1800–1883)" \f "Place" } in 1800. She died in Lenox{ XE "USA, Massachusetts, Berkshire, Lenox:(42.3565° N, 73.2849° W):Sears, Nancy (1800–1883)" \f "Place" } in 1883 at the age of 83.

Nancy Sears married **Levi Butler**{ XE "Butler:Levi (1796–)" \f "Name" \b \i } on Thursday, 1st November 1821, in Lenox{ XE "USA, Massachusetts, Berkshire, Lenox:(42.3565° N, 73.2849° W):Sears, Nancy (1800–1883)" \f "Place" }. They had five children: Luther (1822–), A (1824–), John (1826–), Marshall (1828–) and Maria (1830–).

Levi was born at perhaps in Lenox{ XE "USA, Massachusetts, Berkshire, Lenox:(42.3565° N, 73.2849° W):Butler, Levi (1796–)" \f "Place" } in 1796.

- m III. **Marshall Sears**{ XE "Sears:Marshall (1802–1883)" \f "Name" \b } was born in Lenox{ XE "USA, Massachusetts, Berkshire, Lenox:(42.3565° N, 73.2849° W):Sears, Marshall (1802–1883)" \f "Place" } on 24th February 1802.^[147, 149] He died in Lenox{ XE "USA, Massachusetts, Berkshire, Lenox:(42.3565° N, 73.2849° W):Sears, Marshall (1802–1883)" \f "Place" } on 9th July 1883, at the age of 81.^[147, 149] Marshall was buried in Lenox{ XE "USA, Massachusetts, Berkshire, Lenox:(42.3565° N, 73.2849° W):Sears, Marshall (1802–1883)" \f "Place" }.^[149]



Marshall

At the age of 27, Marshall Sears married **Mary Polly Sabin**{ XE "Sabin:Mary \"Polly\" (1803–1879)" \f "Name" \b \i } on Sunday, 30th August 1829, in Lenox{ XE "USA, Massachusetts, Berkshire, Lenox:(42.3565° N, 73.2849° W):Sears, Marshall (1802–1883)" \f "Place" } when she was 26 years old. They had five children: Mary (1830–1844), Susan (1832–1897), unnamed (1834–1834), Charles (1837–1883) and Nancy (1842–1919).

Polly was born in Lenox{ XE "USA, Massachusetts, Berkshire, Lenox:(42.3565° N, 73.2849° W):Sabin, Mary \"Polly\" (1803–1879)" \f "Place" } on Thursday, 3rd February 1803. She was the daughter of Origen Sabin{ XE "Sabin:Origen" \f "Name" \i } and Hannah Osborn{ XE "Osborn:Hannah" \f "Name" \i }.

Polly reached 76 years of age and died in Lenox{ XE "USA, Massachusetts, Berkshire, Lenox:(42.3565° N, 73.2849° W):Sabin, Mary \"Polly\" (1803–1879)" \f "Place" } on 2nd October 1879.

- m IV. **Zachariah P Sears**{ XE "Sears:Zachariah P (1804–1900)" \f "Name" \b } was born in Lenox{ XE "USA, Massachusetts, Berkshire, Lenox:(42.3565° N, 73.2849° W):Sears, Zachariah P (1804–1900)" \f "Place" } on 14th March 1804.^[152] He died in prob, Lenox,{ XE "USA, Massachusetts, Berkshire, Lenox, prob: :Sears, Zachariah P (1804–1900)" \f "Place" } on 19th March 1900, at the age of 96.^[152] Zachariah P was buried in Lenox{ XE "USA, Massachusetts, Berkshire, Lenox:(42.3565° N, 73.2849° W):Sears, Zachariah P (1804–1900)" \f "Place" }.^[152]



Zachariah

¹⁵² Ancestry.com, U.S., Find A Grave Index, 1600s–Current (Provo, UT, USA, Ancestry.com Operations, Inc., 2012), <https://www.findagrave.com/memorial/18328377>.

At the age of 27, Zachariah P Sears married **Mariette Judd**{ XE "Judd:Mariette (1811-1881)" \f "Name" \b \i } on Sunday, 11th March 1832, when she was 20 years old.^[149, 153] pub. They had one daughter: Anna (1833-).

Mariette was born in Lenox{ XE "USA, Massachusetts, Berkshire, Lenox:(42.3565° N, 73.2849° W):Judd, Mariette (1811-1881)" \f "Place" } on Thursday, 21st March 1811.^[149, 153] She was the daughter of Lyman Judd{ XE "Judd:Lyman" \f "Name" \i } and Amanda --Judd{ XE "--Judd:Amanda" \f "Name" \i }.

Mariette reached 70 years of age and died in Lenox{ XE "USA, Massachusetts, Berkshire, Lenox:(42.3565° N, 73.2849° W):Judd, Mariette (1811-1881)" \f "Place" } on 1st May 1881.^[149, 153] She was buried in Lenox{ XE "USA, Massachusetts, Berkshire, Lenox:(42.3565° N, 73.2849° W):Judd, Mariette (1811-1881)" \f "Place" }.^[149]

m

V. **Luther Sears**{ XE "Sears:Luther (1806-1877)" \f "Name" \b } was born in Lenox{ XE "USA, Massachusetts, Berkshire, Lenox:(42.3565° N, 73.2849° W):Sears, Luther (1806-1877)" \f "Place" } on 26th November 1806.^[147, 149, 154, 155] He died in Lenox{ XE "USA, Massachusetts, Berkshire, Lenox:(42.3565° N, 73.2849° W):Sears, Luther (1806-1877)" \f "Place" } on 16th February 1877, at the age of 70.^[147, 149] Luther was buried in New Lenox Cemetery, Lenox{ XE "USA, Massachusetts, Berkshire, Lenox, New Lenox Cemetery: :Sears, Luther (1806-1877)" \f "Place" }.^[149]



Luther

Luther Sears married **Chloe Clark**{ XE "Clark:Chloe (1807-1847)" \f "Name" \b \i } in September 1832.^[149, 154] They had two children: Elizabeth (1837-1838) and Martin (1842-1908).

Chloe was born at perhaps in Lenox{ XE "USA, Massachusetts, Berkshire, Lenox:(42.3565° N, 73.2849° W):Clark, Chloe (1807-1847)" \f "Place" } on Saturday, 21st March 1807.^[154] She reached 39 years of age and died on 18th March 1847.^[149] Chloe was buried in Lenox{ XE "USA, Massachusetts, Berkshire, Lenox:(42.3565° N, 73.2849° W):Clark, Chloe (1807-1847)" \f "Place" }.^[149]

Birth: unknown Death: Mar. 18, 1847 wife of Luther Sears, Jr., ae 39 Burial: New Lenox Cemetery Lenox Berkshire County Massachusetts, USA Edit Virtual Cemetery info [?] Created by: Elsie Saar Record added: Aug 10, 2010 Find A Grave Memorial# 56906158

Luther Sears married **Emily Jerusha Jerush Howland**{ XE "Howland:Emily Jerusha \"Jerush\" (1812-1898)" \f "Name" \b \i } on Wednesday, 10th November 1847. They had two sons: Edwin (1849-1888) and David (1854-1861).

Jerush was born in 1812. She was the daughter of Joseph Howland{ XE "Howland:Joseph" \f "Name" \i } and Jerusha Dewey{ XE "Dewey:Jerusha" \f "Name" \i }.

Jerush reached 86 years of age and died in Lenox{ XE "USA, Massachusetts, Berkshire, Lenox:(42.3565° N, 73.2849° W):Howland, Emily Jerusha \"Jerush\" (1812-1898)" \f "Place" } on 11th February 1898. She was buried in Sears Cemetery, New Lenox Rd, Lenox{ XE "USA, Massachusetts, Berkshire, Lenox, New Lenox Rd, Sears Cemetery: :Howland, Emily Jerusha \"Jerush\" (1812-1898)" \f "Place" }.

Birth: unknown Death: Feb. 11, 1898 ae 81 years Burial: New Lenox Cemetery Lenox Berkshire County Massachusetts, USA Edit Virtual Cemetery info [?] Created by: Elsie Saar Record added: Aug 10, 2010 Find A Grave Memorial# 56906730

¹⁵³ Ancestry.com, Massachusetts, Death Records, 1841-1915 (Provo, UT, USA, Ancestry.com Operations, Inc., 2013), Ancestry.com.
[Source citation includes one media item]

¹⁵⁴ Ancestry.com, Massachusetts, Death Records, 1841-1915 (Provo, UT, USA, Ancestry.com Operations, Inc., 2013), Ancestry.com, New England Historic Genealogical Society; Boston, Massachusetts; Massachusetts Vital Records, 1840-1911.

¹⁵⁵ Ancestry.com, Massachusetts, Marriage Records, 1840-1915 (Provo, UT, USA, Ancestry.com Operations, Inc., 2013), Ancestry.com, New England Historic Genealogical Society; Boston, Massachusetts; Massachusetts Vital Records, 1911-1915.

- f VI. **Marietta Sears**{ XE "Sears:Marietta (1809–1896)" \f "Name" \b } was born in Lenox{ XE "USA, Massachusetts, Berkshire, Lenox:(42.3565° N, 73.2849° W):Sears, Marietta (1809–1896)" \f "Place" } on 31st August 1809.^[149] She died in Volney, Oswego County, New York,{ XE "USA, New York, Oswego County, Volney:(43.3428° N, 76.3581° W):Sears, Marietta (1809–1896)" \f "Place" } on 18th April 1896, at the age of 86.^[149] Marietta was buried in Fulton, Oswego{ XE "USA, New York, Oswego, Fulton:(43.3229° N, 76.4172° W):Sears, Marietta (1809–1896)" \f "Place" }.^[149]



Marietta

Marietta Sears married **Ira Carrier**{ XE "Carrier:Ira (1805–)" \f "Name" \b \i } on Thursday, 14th May 1829. They had one son: Ira (1830–).

Ira was born at perhaps in Lenox, Berkshire, Massachusetts,{ XE "USA, Massachusetts, Berkshire, Lenox:(42.3565° N, 73.2849° W):Carrier, Ira (1805–)" \f "Place" } in 1805.

- f VII. **Ann Maria Sears**{ XE "Sears:Ann Maria (1813–1847)" \f "Name" \b } was born in Lenox{ XE "USA, Massachusetts, Berkshire, Lenox:(42.3565° N, 73.2849° W):Sears, Ann Maria (1813–1847)" \f "Place" } on 30th August 1813. She died in Volney, Oswego, New York,{ XE "USA, New York, Oswego, Volney:(43.3428° N, 76.3581° W):Sears, Ann Maria (1813–1847)" \f "Place" } on 22nd August 1847, at the age of 33.

Ann Maria Sears married **Lyman C Judd**{ XE "Judd:Lyman C" \f "Name" \b \i }. They had two children: Alphonse and Sarah.

- f VIII. **Harriet Sears**{ XE "Sears:Harriet (1819–1888)" \f "Name" \b } was born in Lenox{ XE "USA, Massachusetts, Berkshire, Lenox:(42.3565° N, 73.2849° W):Sears, Harriet (1819–1888)" \f "Place" } on 7th August 1819.^[149] She died in Lenox{ XE "USA, Massachusetts, Berkshire, Lenox:(42.3565° N, 73.2849° W):Sears, Harriet (1819–1888)" \f "Place" } on 1st August 1888, at the age of 68.^[149] Harriet was buried in Lenox{ XE "USA, Massachusetts, Berkshire, Lenox:(42.3565° N, 73.2849° W):Sears, Harriet (1819–1888)" \f "Place" }.^[149]



Harriet

Harriet married **Frederick Washburn**{ XE "Washburn:Frederick (1815–)" \f "Name" \b \i }. They had one son: George (1841–).

Frederick was born in Lenox{ XE "USA, Massachusetts, Berkshire, Lenox:(42.3565° N, 73.2849° W):Washburn, Frederick (1815–)" \f "Place" } in 1815.

Family of Elizabeth Sears and Robert McKnight{ TC "Elizabeth Sears and Robert McKnight" \I 3 \f C}

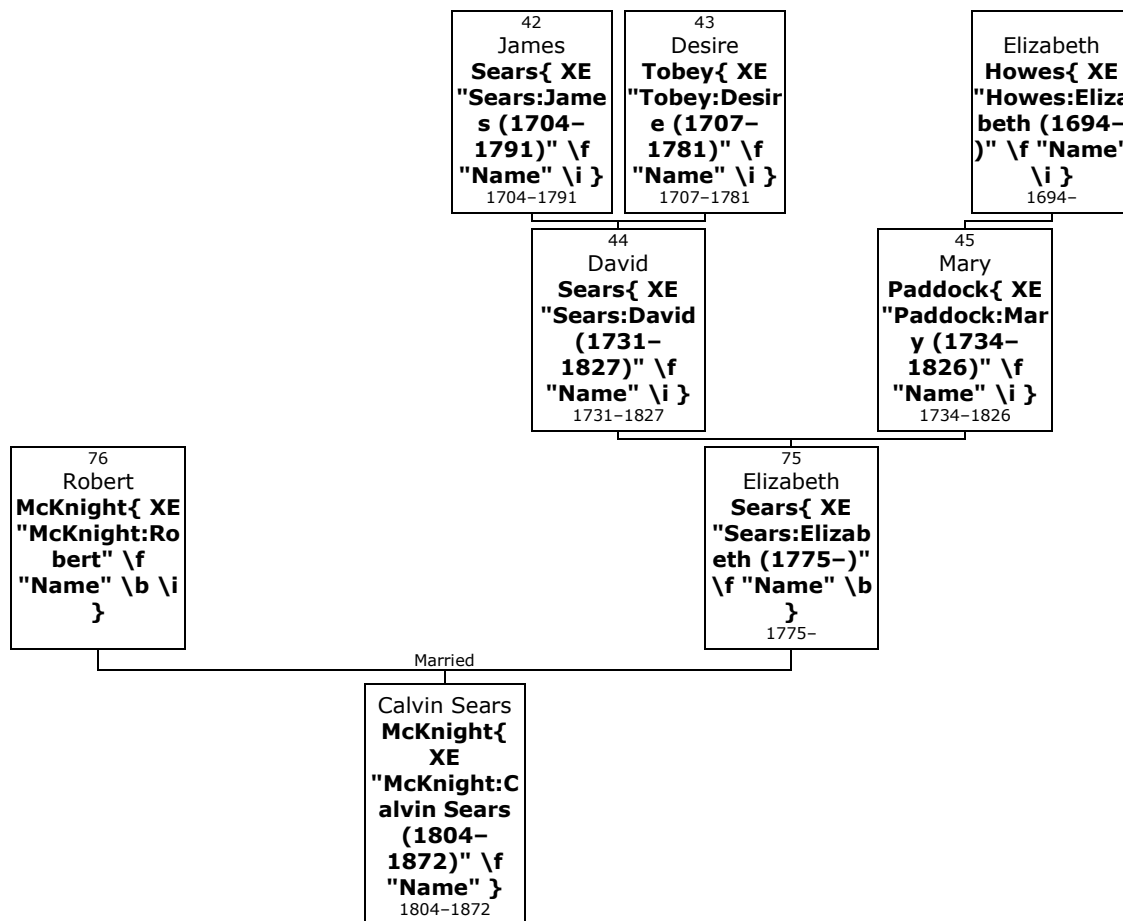

- 75. Elizabeth⁴ Sears**{ XE "Sears:Elizabeth (1775-)" \f "Name" \b } (*David³, James²*) was born in 1775 at perhaps in Lenox, Berkshire, Massachusetts, USA{ XE "USA, Massachusetts, Berkshire, Lenox:(42.3565° N, 73.2849° W):Sears, Elizabeth (1775-)" \f "Place" }.^[156] She was the daughter of David Sears{ XE "Sears:David (1731-1827)" \f "Name" \i } (44) and Mary Paddock{ XE "Paddock:Mary (1734-1826)" \f "Name" \i } (45).

S P May, No 745, said she married Jonathan Root of Pittsfield but records from Sara Murphy prove differently.

From: JMKBMor@aol.com [mailto:JMKBMor@aol.com] Sent: Thursday, June 22, 2006 9:58 AM To: LRSEARS@CAPECOD.NET Subject: Descendant I saw your web site with a history of the Sears name and I wondered if you have any information on one of my relatives. Elisabeth Sears was born 8/17/1773 in location unknown. She married Robert McKnight 12/1/1791 in New Lebanon, Columbia Couty, New York Thanks John Moore

judithsearsallen

Jun 21, 2017 While walking thru a cemetery in Missouri three or four years ago, I found a stone with the name Calvin Sears McKnight. Curious as to who it was, I started looking for his records. I traced him to my Sears family of David Sears/Mary Paddock. I've looked several years for his mother and father. Finally while in the library in Pittsfield a man there found a record of Robert McKnight and Elisabeth Sears in the Genealogical Abstracts of Rev. War Pension Files (Vol III N-Z, page 2293) Lots of additional info. But it proves that it was Elisabeth who married Robert. Now looking for Polly to see if she married a Jonathan Root. Thought you might like to look at the record.

¹⁵⁶ Ancestry.com, U.S. Pensioners, 1818-1872 (Provo, UT, USA, Ancestry.com Operations Inc, 2007), Ancestry.com, The National Archives; Washington, D.C.; Ledgers of Payments, 1818-1872, to U.S. Pensioners Under Acts of 1818 Through 1858 From Records of the Office of the Third Auditor of the Treasury; Record Group Title: Records of the Accounting Officers of the Depa. [Source citation includes one media item]

Judith Sears Allen

<https://www.wikitree.com/wiki/Sears-4754>

More facts and events for Elizabeth Sears:

Residence: 1836 - 1848^[156]

Residence: 1843 - 1862^[156]

76. She married **Robert McKnight**^[156, 157-158] { XE "McKnight:Robert" \f "Name" \b \i }. They had one son: Calvin (1804-1872).

Robert served in the military in USA^[158] { XE "USA: :McKnight, Robert" \f "Place" }.

More facts and events for Robert McKnight:

Residence: 1836 - 1848 Albany, New York^[156] { XE "USA, New York, Albany:(42.6029° N, 73.9717° W):McKnight, Robert" \f "Place" }.

Residence: 1843 - 1862 Albany^[156] { XE "USA, New York, Albany:(42.6029° N, 73.9717° W):McKnight, Robert" \f "Place" }.

Residence: Manhattan, New York^[157] { XE "USA, New York, New York, Manhattan:(40.7834° N, 73.9663° W):McKnight, Robert" \f "Place" }.

Residence: New York^[157] { XE "USA, New York:(42.7531° N, 74.2224° W):McKnight, Robert" \f "Place" }.

Son of Elizabeth Sears and Robert McKnight:

m I. **Calvin Sears⁵ McKnight**^[159, 160-161] { XE "McKnight:Calvin Sears (1804-1872)" \f "Name" \b } was born in New York^[156] { XE "USA, New York:(42.7531° N, 74.2224° W):McKnight, Calvin Sears (1804-1872)" \f "Place" } in 1804. He died in 1872 at the age of 68.



Calvin

More facts and events for Calvin Sears McKnight:

Residence: 1850 Oakfield, Fond du Lac, Wisconsin^[160] { XE "USA, Wisconsin, Fond du Lac, Oakfield:(43.6861° N, 88.5465° W):McKnight, Calvin Sears (1804-1872)" \f "Place" }.

Residence: 1870 Green City, Nodaway, Missouri^[159] { XE "USA, Missouri, Nodaway, Green City:(40.2682° N, 92.9532° W):McKnight, Calvin Sears (1804-1872)" \f "Place" }.
Post Office: Maryville

Calvin Sears married **Huldah Russell**^[160-162] { XE "Russell:Huldah (ca.1816-)" \f "Name" \b \i }.

¹⁵⁷ Ancestry.com, U.S., Revolutionary War Pension and Bounty-Land Warrant Application Files, 1800-1900 (Provo, UT, USA, Ancestry.com Operations, Inc., 2010), Ancestry.com. [Source citation includes one media item]

¹⁵⁸ Ancestry.com, U.S., Revolutionary War Rolls, 1775-1783 (Provo, UT, USA, Ancestry.com Operations, Inc., 2007), Ancestry.com.

¹⁵⁹ Ancestry.com, 1870 United States Federal Census (Provo, UT, USA, Ancestry.com Operations, Inc., 2009), Ancestry.com, Year: 1870; Census Place: Green, Nodaway, Missouri; Roll: M593_795; Page: 543B; Image: 390961; Family History Library Film: 552294.

¹⁶⁰ Ancestry.com, 1850 United States Federal Census (Provo, UT, USA, Ancestry.com Operations, Inc., 2009), Ancestry.com, Year: 1850; Census Place: Oakfield, Fond du Lac, Wisconsin; Roll: M432_997; Page: 299B; Image: 117.

¹⁶¹ Ancestry.com, Washington, Select Death Certificates, 1907-1960 (Provo, UT, USA, Ancestry.com Operations, Inc., 2014), Ancestry.com.

¹⁶² Ancestry.com and The Church of Jesus Christ of Latter-day Saints, 1880 United States Federal Census (Provo, UT, USA, Ancestry.com Operations Inc, 2010), Ancestry.com, Year: 1880; Census Place: Greene, Nodaway, Missouri; Roll: 706; Family

They had twelve children: Jane (1834–), Mary (1837–1881), Ellen (1845–), John (1846–1913), Alice (ca.1848–1908), Mary (1849–), Agnes (1850–1934), Elizabeth (1852–), Louisa (1855–1927), Cordelia (1857–), Lula (1859–) and Francisca (1861–). Huldah was born in New York{ XE "USA, New York:(42.7531° N, 74.2224° W):Russell, Huldah (ca.1816–)" \f "Place" } about 1816.^[160, 162]

Family of James Sears and Lucy Judd{ TC "James Sears and Lucy Judd" \I 3 \f C}

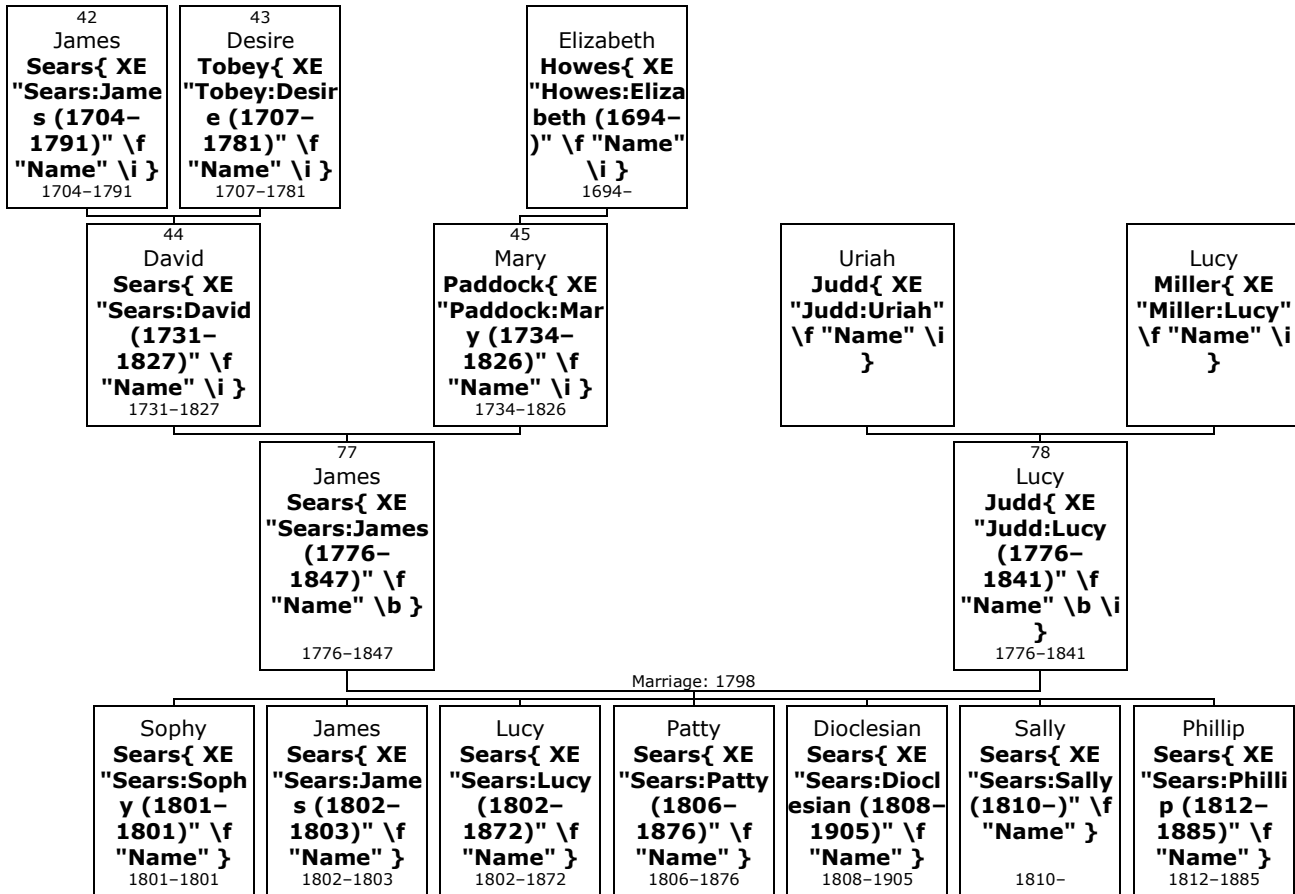

- 77. James⁴ Sears**{ XE "Sears:James (1776–1847)" \f "Name" \b } (*David³, James²*) was born on Wednesday, 15th May 1776, in Lenox, Berkshire, Massachusetts, USA{ XE "USA, Massachusetts, Berkshire, Lenox:(42.3565° N, 73.2849° W):Sears, James (1776–1847)" \f "Place" }.^[163, 164–165] He was the son of David Sears{ XE "Sears:David (1731–1827)" \f "Name" \i } (44) and Mary Paddock{ XE "Paddock:Mary (1734–1826)" \f "Name" \i } (45).

James died in Richford, Tioga, New York,{ XE "USA, New York, Tioga, Richford:(42.3556° N, 76.2011° W):Sears, James (1776–1847)" \f "Place" } on 22nd February 1847, at the age of 70.^[163, 164] He was buried in Richford, Tioga County{ XE "USA, New York, Tioga County, Richford:(42.3556° N, 76.2011° W):Sears, James (1776–1847)" \f "Place" }.^[163]

!The James Sears in my family who was born 15 May 1776 in Lenox, died in Richford, NY 22 Feb 1847. He married Lucy Judd b. Pittsfield 28 Nov 1776 and d. Richford, NY (no date). They were married in Lenox on

History Film: 1254706; Page: 164A; Enumeration District: 259; Image: 0559.
[Source citation includes one media item]

¹⁶³ Ancestry.com, U.S., Find A Grave Index, 1600s-Current (Provo, UT, USA, Ancestry.com Operations, Inc., 2012), Ancestry.com.

¹⁶⁴ Ancestry.com, U.S., Sons of the American Revolution Membership Applications, 1889-1970 (Provo, UT, USA, Ancestry.com Operations, Inc., 2011), Ancestry.com.
[Source citation includes one media item]

¹⁶⁵ Ancestry.com, Massachusetts, Town and Vital Records, 1620-1988 (Provo, UT, USA, Ancestry.com Operations, Inc., 2011), Ancestry.com.
[Source citation includes one media item]

23 Dec 1798. They had two children buried in Sears cemetery in Lenox, MA. They were James (b. abt Jun 1802 d. Apr 1803) and Sophy (b. May 1801 d. 28 Nov 1801). James father was David Sears (b.1731 in Yarmouth d. 1827 in Lenox) and mother Mary Paddock (b. 1734 in Marshfield, MA, I think. d. 1826 in Lenox). Both David and Mary are buried in Sears Cemetery in Lenox. There were no Richards in David & Mary's family. There appeared to be quite a bit of movement of the family between the Albany area and the Lenox/Pittsfield area. And my ggg grandfather Luther Sears(brother to James) moved to Volney, NY where he died Jul 1857. I have been trying to find information on his wife, Anna Foster. She may have returned to Lenox after Luther's death, as her death is recorded in the church records. Or it may be that someone notified the church that she had died, as the church record does not say where she died, but when. She does not appear to be buried in the Sears cemetery. Judith Allen?

<http://trees.ancestry.com/owt/person.aspx?pid=8777481&st=1>

<https://www.wikitree.com/wiki/Sears-3180>

S P May p 273 #740



#1605 Lucy, 1606 Patty, 1607 Diolesian 1608 Sally 1609 Philip

- 78.** At the age of 22, James married **Lucy Judd**{ XE "Judd:Lucy (1776-1841)" \f "Name" \b \i } on Sunday, 23rd December 1798, in Lenox, Berkshire, Massachusetts,{ XE "USA, Massachusetts, Berkshire, Lenox:(42.3565° N, 73.2849° W):Sears, James (1776-1847)" \f "Place" } when she was 22 years old.^[163-165] They had seven children: Sophy (1801-1801), James (1802-1803), Lucy (1802-1872), Patty (1806-1876), Dioclesian (1808-1905), Sally (1810-) and Phillip (1812-1885).

Lucy was born in Pittsfield{ XE "USA, Massachusetts, Berkshire, Pittsfield:(42.4501° N, 73.2454° W):Judd, Lucy (1776-1841)" \f "Place" } on Thursday, 28th November 1776.^[163, 164] She was the daughter of Uriah Judd{ XE "Judd:Uriah" \f "Name" \i } and Lucy Miller{ XE "Miller:Lucy" \f "Name" \i }.

Lucy reached 64 years of age and died in Richford, Tioga, New York,{ XE "USA, New York, Tioga, Richford:(42.3556° N, 76.2011° W):Judd, Lucy (1776-1841)" \f "Place" } in 1841.^[163, 164] She was buried in Richford, Tioga County{ XE "USA, New York, Tioga County, Richford:(42.3556° N, 76.2011° W):Judd, Lucy (1776-1841)" \f "Place" }.^[163]

Children of James Sears and Lucy Judd:

- f I. **Sophy⁵ Sears**{ XE "Sears:Sophy (1801-1801)" \f "Name" \b } was born in May 1801. She died on 28th November 1801. Sophy was buried in Sears Cemetery, Lenox{ XE "USA, Massachusetts, Berkshire, Lenox, Sears Cemetery: :Sears, Sophy (1801-1801)" \f "Place" }. 
- m II. **James Sears**{ XE "Sears:James (1802-1803)" \f "Name" \b } was born in June 1802. He died on 21st April 1803. James was buried in Sears Cemetery, Lenox{ XE "USA, Massachusetts, Berkshire, Lenox, Sears Cemetery: :Sears, James (1802-1803)" \f "Place" }. 
- f III. **Lucy Sears**{ XE "Sears:Lucy (1802-1872)" \f "Name" \b } was born in Lenox{ XE "USA, Massachusetts, Berkshire, Lenox:(42.3565° N, 73.2849° W):Sears, Lucy (1802-1872)" \f "Place" } on 18th November 1802. She died in June 1872 at the age of 69. At the age of 25, Lucy married **George Cargill**{ XE "Cargill:George (1802-1872)" \f "Name" \b \i } on Thursday, 11th September 1828, in Lenox{ XE "USA, Massachusetts, Berkshire, Lenox:(42.3565° N, 73.2849° W):Sears, Lucy (1802-1872)" \f "Place" } when he was 26 years old. They had no known children. George was born in Goshen, Hampshire,{ XE "USA, Massachusetts, Hampshire, Goshen:(42.4404° N, 72.7996° W):Cargill, George (1802-1872)" \f "Place" } on Sunday, 31st January 1802. He was the son of John Cargill{ XE "Cargill:John (1776-)" \f "Name" \i } and Mary Crow{ XE "Crow:Mary (1780-)" \f "Name" \i }. George reached 70 years of age and died in Newark Valley, Tioga, New York,{ XE "USA, New York, Tioga, Newark Valley:(42.2237° N, 76.1833° W):Cargill, George (1802-1872)" \f "Place" } on 22nd September 1872.
- f IV. **Patty Sears**{ XE "Sears:Patty (1806-1876)" \f "Name" \b } was born in Lenox{ XE "USA, Massachusetts, Berkshire, Lenox:(42.3565° N, 73.2849° W):Sears, Patty (1806-1876)" \f "Place" } on 18th May 1806. She died in 1876 at the age of 69.

Patty Sears married **James Bristol**{ XE "Bristol:James (1802-)" \f "Name" \b \i }. They had no known children.

James was born at perhaps in Lenox{ XE "USA, Massachusetts, Berkshire, Lenox:(42.3565° N, 73.2849° W):Bristol, James (1802-)" \f "Place" } in 1802.

- m V. **Dioclesian Sears**{ XE "Sears:Dioclesian (1808-1905)" \f "Name" \b } was born in Lenox{ XE "USA, Massachusetts, Berkshire, Lenox:(42.3565° N, 73.2849° W):Sears, Dioclesian (1808-1905)" \f "Place" } on 15th November 1808.^[163, 166] He died in 1905 at the age of 96.^[163] Dioclesian was buried in Richford, Tioga County{ XE "USA, New York, Tioga County, Richford:(42.3556° N, 76.2011° W):Sears, Dioclesian (1808-1905)" \f "Place" }.^[163]



Dioclesian

More facts and events for Dioclesian Sears:

Residence: 1855 Richford, Tioga{ XE "USA, New York, Tioga, Richford:(42.3556° N, 76.2011° W):Sears, Dioclesian (1808-1905)" \f "Place" }.^[166]
Relation to Head of House: Head

Dioclesian Sears married **Laura L Holcomb**{ XE "Holcomb:Laura L (1817-1903)" \f "Name" \b \i } on Saturday, 11th December 1830, in Richford{ XE "USA, New York, Tioga, Richford:(42.3556° N, 76.2011° W):Sears, Dioclesian (1808-1905)" \f "Place" }.^[163, 166] They had nine children: James (1837-), Lucy (1839-1908), Laura (1841-1912), Genura (1844-1847), Mary (1847-), Emily (1848-1941), Sarah (1853-1901), Flora (1856-1871) and Agnes (1858-).

Laura L was born in Hamilton, Madison,{ XE "USA, New York, Madison, Hamilton:(42.827° N, 75.5446° W):Holcomb, Laura L (1817-1903)" \f "Place" } in 1817.^[163, 166] She reached 86 years of age and died in 1903.^[163] Laura L was buried in Richford, Tioga County{ XE "USA, New York, Tioga County, Richford:(42.3556° N, 76.2011° W):Holcomb, Laura L (1817-1903)" \f "Place" }.^[163]

- f VI. **Sally Sears**{ XE "Sears:Sally (1810-)" \f "Name" \b } was born in Lenox{ XE "USA, Massachusetts, Berkshire, Lenox:(42.3565° N, 73.2849° W):Sears, Sally (1810-)" \f "Place" } on 9th April 1810.

Sally Sears married **Lucius D Rogers**{ XE "Rogers:Lucius D (1806-)" \f "Name" \b \i } on Sunday, 25th December 1831, in pub, Lenox{ XE "USA, Massachusetts, Berkshire, Lenox, pub: :Sears, Sally (1810-)" \f "Place" }. They had one daughter: Sarah (1832-).

Lucius D was born in Lenox{ XE "USA, Massachusetts, Berkshire, Lenox:(42.3565° N, 73.2849° W):Rogers, Lucius D (1806-)" \f "Place" } in 1806. He died in Richford, Tioga, New York{ XE "USA, New York, Tioga, Richford:(42.3556° N, 76.2011° W):Rogers, Lucius D (1806-)" \f "Place" }.

- m VII. **Phillip Sears**{ XE "Sears:Phillip (1812-1885)" \f "Name" \b } was born in Lenox{ XE "USA, Massachusetts, Berkshire, Lenox:(42.3565° N, 73.2849° W):Sears, Phillip (1812-1885)" \f "Place" } on 21st May 1812.^[163, 164, 167] He died in Richford{ XE "USA, New York, Tioga, Richford:(42.3556° N, 76.2011° W):Sears, Phillip (1812-1885)" \f "Place" } in 1885 at the age of 72.^[163, 164] Phillip was buried in Richford, Tioga County{ XE "USA, New York, Tioga County, Richford:(42.3556° N, 76.2011° W):Sears, Phillip (1812-1885)" \f "Place" }.^[163]



Phillip

More facts and events for Phillip Sears:

Residence: 1865 Richford, Tioga{ XE "USA, New York, Tioga, Richford:(42.3556° N, 76.2011° W):Sears, Phillip (1812-1885)" \f "Place" }.^[167]
Relation to Head of House: Head

¹⁶⁶ Ancestry.com, New York, State Census, 1855 (Provo, UT, USA, Ancestry.com Operations, Inc., 2013), Ancestry.com.

¹⁶⁷ Ancestry.com, New York, State Census, 1865 (Provo, UT, USA, Ancestry.com Operations, Inc., 2014), Ancestry.com.

At the age of 29, Phillip Sears married **Sally Maria Tyler**{ XE "Tyler:Sally Maria (1823-1890)" \f "Name" \b \i } on Thursday, 19th August 1841, in Richford{ XE "USA, New York, Tioga, Richford:(42.3556° N, 76.2011° W):Sears, Phillip (1812-1885)" \f "Place" } when she was 17 years old.^[163, 167] They had seven children: George (1842-1849), Maryette (1844-1877), Uriah (1845-1849), Quincy (1851-1913), Harriet (1853-1927), Anna (1856-1878) and Nellie (1864-1947).

Sally Maria was born in Locke, Cayuga,{ XE "USA, New York, Cayuga, Locke:(42.6606° N, 76.4311° W):Tyler, Sally Maria (1823-1890)" \f "Place" } on Friday, 31st October 1823.^[163, 167] She reached 66 years of age and died in 1890.^[163] Sally Maria was buried in Richford, Tioga County{ XE "USA, New York, Tioga County, Richford:(42.3556° N, 76.2011° W):Tyler, Sally Maria (1823-1890)" \f "Place" }.^[163]

Family of Polly Sears and Robert McKnight{ TC "Polly Sears and Robert McKnight" \I 3 \f C}

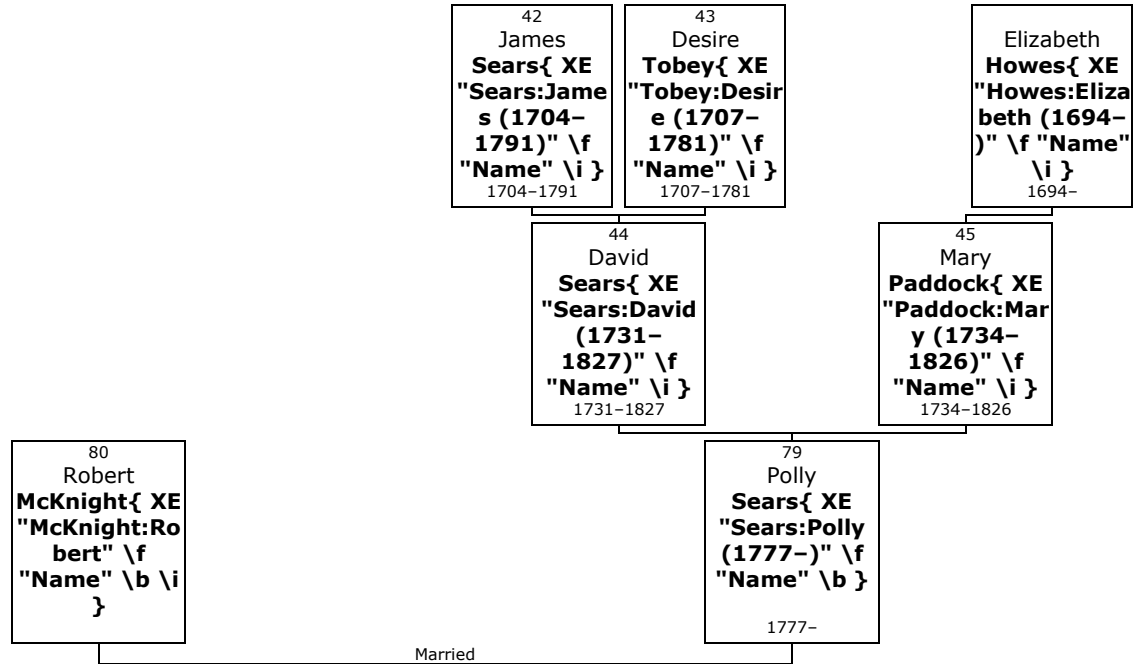

79. Polly⁴ Sears{ XE "Sears:Polly (1777-)" \f "Name" \b } (*David³, James²*) was born in 1777 at perhaps in Lenox, Berkshire, Massachusetts, USA{ XE "USA, Massachusetts, Berkshire, Lenox:(42.3565° N, 73.2849° W):Sears, Polly (1777-)" \f "Place" }. She was the daughter of David Sears{ XE "Sears:David (1731-1827)" \f "Name" \i } (44) and Mary Paddock{ XE "Paddock:Mary (1734-1826)" \f "Name" \i } (45).

S P May No 746

<https://www.wikitree.com/wiki/Sears-4755>

80. She married **Robert McKnight**{ XE "McKnight:Robert" \f "Name" \b \i }.

Zachariah Sears{ TC "Zachariah Sears" \I 3 \f C}

81. Zachariah⁴ Sears{ XE "Sears:Zachariah (1778-1865)" \f "Name" \b } (*David³, James²*) was born in April 1778 in Lenox, Berkshire, Massachusetts, USA{ XE "USA, Massachusetts, Berkshire, Lenox:(42.3565° N, 73.2849° W):Sears, Zachariah (1778-1865)" \f "Place" }.^[168, 169-170] He was the son of David Sears{ XE

¹⁶⁸ Ancestry.com, Massachusetts, Death Records, 1841-1915 (Provo, UT, USA, Ancestry.com Operations, Inc., 2013), Ancestry.com. [Source citation includes one media item]

¹⁶⁹ Ancestry.com, North America, Family Histories, 1500-2000 (Provo, UT, USA, Ancestry.com Operations, Inc., 2016), Ancestry.com, Book Title: Thacher - Thatcher Genealogy : Part 1 : Coat-of-Arms.

¹⁷⁰ Ancestry.com, Massachusetts, Town and Vital Records, 1620-1988 (Provo, UT, USA, Ancestry.com Operations, Inc., 2011), Ancestry.com. [Source citation includes one media item]

"Sears:David (1731–1827)" \f "Name" \i } (44) and Mary Paddock{ XE "Paddock:Mary (1734–1826)" \f "Name" \i } (45).

Zachariah died in Lenox{ XE "USA, Massachusetts, Berkshire, Lenox:(42.3565° N, 73.2849° W):Sears, Zachariah (1778–1865)" \f "Place" } on 17th November 1865, at the age of 87.^[168, 169]

!1820 Census - 4,2 !www.newenglandancestors.org !Ashfield VR SEARS Zechariah [int. Zachariah] of Lenox and Sarah [int. Miss Sally] Hall of A., -, 1806 [int. July 11, 1805]. Marriage

<https://www.wikitree.com/wiki/Sears-4756>

Marriages with Sally Hall and Almira Butler (Page 108) are known.

Family of Zachariah Sears and Sally Hall{ TC "Zachariah Sears and Sally Hall" \I 4 \f C}

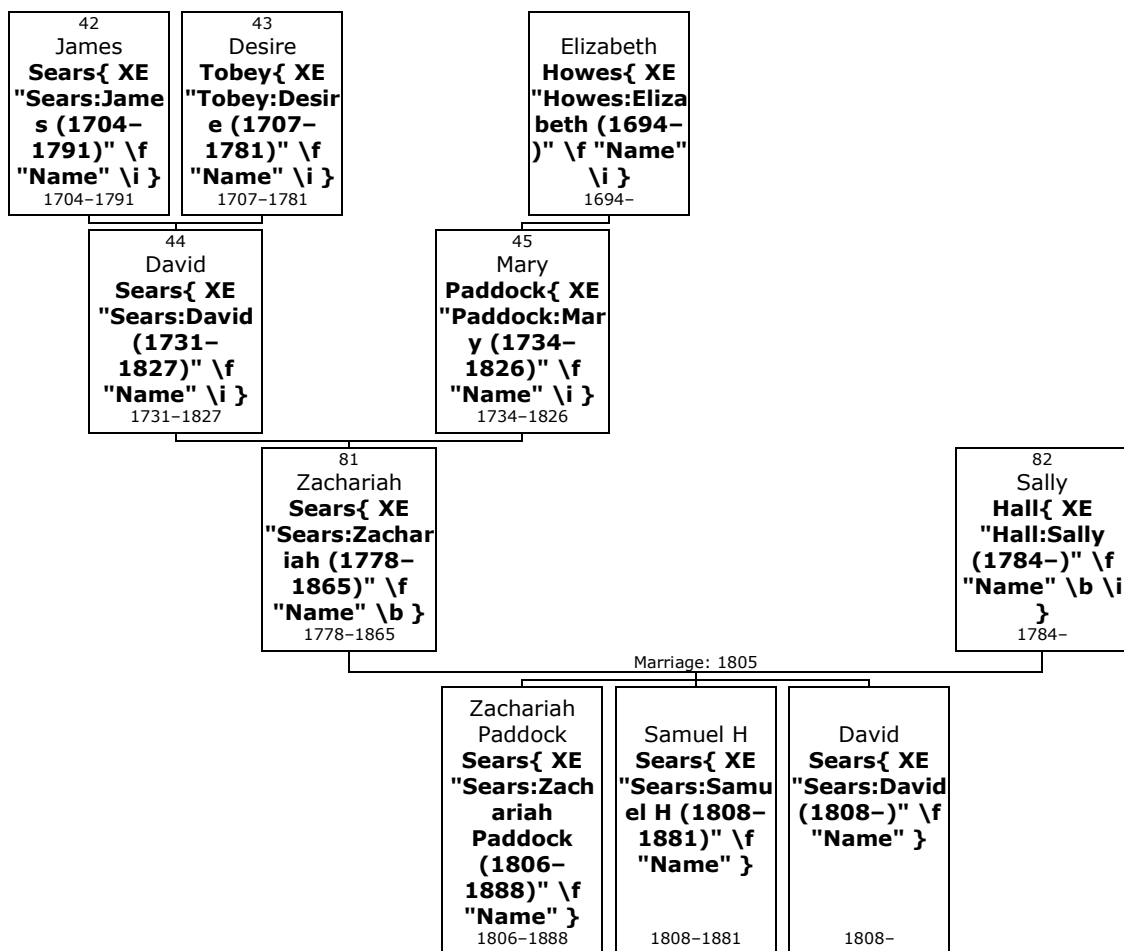

Here are the details about **Zachariah Sears**{ XE "Sears:Zachariah (1778–1865)" \f "Name" \b } first marriage, with Sally Hall. You can read more about Zachariah on page 105.

- 82.** Zachariah Sears married **Sally Hall**{ XE "Hall:Sally (1784–)" \f "Name" \b \i } on Monday, 29th July 1805, in pub, Lenox{ XE "USA, Massachusetts, Berkshire, Lenox, pub: :Sears, Zachariah (1778–1865)" \f "Place" }.^[170] They had three sons: Zachariah (1806–1888), Samuel (1808–1881) and David (1808–).

Sally was born in Ashfield, Franklin,{ XE "USA, Massachusetts, Franklin, Ashfield:(42.5265° N, 72.7884° W):Hall, Sally (1784–)" \f "Place" } in 1784.

Sons of Zachariah Sears and Sally Hall:

m I. **Zachariah Paddock⁵ Sears**{ XE "Sears:Zachariah Paddock (1806–1888)" \f "Name" \b } was born in Lenox{ XE "USA, Massachusetts, Berkshire, Lenox:(42.3565° N, 73.2849° W):Sears, Zachariah Paddock (1806–1888)" \f "Place" } in 1806.^[170, 171, 172, 173, 174–175] He died in Pennellville{ XE "USA, New York, Oswego, Pennellville:(43.2825° N, 76.2708° W):Sears, Zachariah Paddock (1806–1888)" \f "Place" } on 6th April 1888, at the age of 82.^[175] Zachariah Paddock was buried in Pennellville, Oswego County{ XE "USA, New York, Oswego County, Pennellville:(43.2825° N, 76.2708° W):Sears, Zachariah Paddock (1806–1888)" \f "Place" }.^[175]



Zachariah

More facts and events for Zachariah Paddock Sears:

Residence: 1850 Schroepfel, Oswego{ XE "USA, New York, Oswego, Schroepfel:(43.2626° N, 76.2794° W):Sears, Zachariah Paddock (1806–1888)" \f "Place" }.^[174]

Residence: 1860 Schroepfel{ XE "USA, New York, Oswego, Schroepfel:(43.2626° N, 76.2794° W):Sears, Zachariah Paddock (1806–1888)" \f "Place" }.^[172]

Residence: 1865 Schroepfel{ XE "USA, New York, Oswego, Schroepfel:(43.2626° N, 76.2794° W):Sears, Zachariah Paddock (1806–1888)" \f "Place" }.^[171]

Relation to Head of House: Head

Residence: 1st June 1875 Volney{ XE "USA, New York, Oswego, Volney:(43.3428° N, 76.3581° W):Sears, Zachariah Paddock (1806–1888)" \f "Place" }.^[173]

Relation to Head of House: Father

At the age of 23, Zachariah Paddock married **Mary Ann Millard**{ XE "Millard:Mary Ann (1807–1876)" \f "Name" \b \i } on Thursday, 19th March 1829, in Pittsfield, Berkshire, Massachusetts,{ XE "USA, Massachusetts, Berkshire, Pittsfield:(42.4501° N, 73.2454° W):Sears, Zachariah Paddock (1806–1888)" \f "Place" } when she was 21 years old.^[170, 171, 173, 175] They had five children: (unknown given name) (ca.1825–), (unknown given name) (ca.1825–), Kate (1833–1925), David (1836–1895) and Mary (1840–1866).

Mary Ann was born in Ashfield, Franklin,{ XE "USA, Massachusetts, Franklin, Ashfield:(42.5265° N, 72.7884° W):Millard, Mary Ann (1807–1876)" \f "Place" } on Monday, 17th August 1807.^[171, 173, 175] She was the daughter of Samuel Millard{ XE "Millard:Samuel" \f "Name" \i } and Chloe --Millard{ XE "--Millard:Chloe" \f "Name" \i }.

Mary Ann reached 68 years of age and died in 1876.^[175] She was buried in Pennellville, Oswego County{ XE "USA, New York, Oswego County, Pennellville:(43.2825° N, 76.2708° W):Millard, Mary Ann (1807–1876)" \f "Place" }.^[175]

Carla Miller [carlaj@banet.net] shows Mary Ann Miller - b: 17 AUG 1807 in Pittsfield, Massachusetts

¹⁷¹ Ancestry.com, New York, State Census, 1865 (Provo, UT, USA, Ancestry.com Operations, Inc., 2014), Ancestry.com.

¹⁷² Ancestry.com, 1860 United States Federal Census (Provo, UT, USA, Ancestry.com Operations, Inc., 2009), Ancestry.com, Year: 1860; Census Place: Schroepfel, Oswego, New York; Roll: M653_837; Page: 482; Family History Library Film: 803837.

¹⁷³ Ancestry.com, New York, State Census, 1875 (Provo, UT, USA, Ancestry.com Operations, Inc., 2013), Ancestry.com.

¹⁷⁴ Ancestry.com, 1850 United States Federal Census (Provo, UT, USA, Ancestry.com Operations, Inc., 2009), Ancestry.com, Year: 1850; Census Place: Schroepfel, Oswego, New York; Roll: M432_577; Page: 266B; Image: 31.

¹⁷⁵ Ancestry.com, U.S., Find A Grave Index, 1600s-Current (Provo, UT, USA, Ancestry.com Operations, Inc., 2012), Ancestry.com.

m II. **Samuel H Sears**{ XE "Sears:Samuel H (1808-1881)" \f "Name" \b } was born in Lenox{ XE "USA, Massachusetts, Berkshire, Lenox:(42.3565° N, 73.2849° W):Sears, Samuel H (1808-1881)" \f "Place" } in 1808.^[170, 175] He died on 16th May 1881, at the age of 73.^[175] Samuel H was buried in Lenox{ XE "USA, Massachusetts, Berkshire, Lenox:(42.3565° N, 73.2849° W):Sears, Samuel H (1808-1881)" \f "Place" }.^[175]



Samuel

Samuel H Sears married **Elizabeth M Bradley**{ XE "Bradley:Elizabeth M (1821-)" \f "Name" \b \i } on Wednesday, 24th October 1838, in Lenox{ XE "USA, Massachusetts, Berkshire, Lenox:(42.3565° N, 73.2849° W):Sears, Samuel H (1808-1881)" \f "Place" }.^[170] They had one son: David (1843-1847).

Elizabeth M was born at perhaps in Lenox{ XE "USA, Massachusetts, Berkshire, Lenox:(42.3565° N, 73.2849° W):Bradley, Elizabeth M (1821-)" \f "Place" } in 1821.

m III. **David Sears**{ XE "Sears:David (1808-)" \f "Name" \b } was born in Lenox{ XE "USA, Massachusetts, Berkshire, Lenox:(42.3565° N, 73.2849° W):Sears, David (1808-)" \f "Place" } in 1808.

Family of Zachariah Sears and Almira Butler{ TC "Zachariah Sears and Almira Butler" \I 4 \f C}

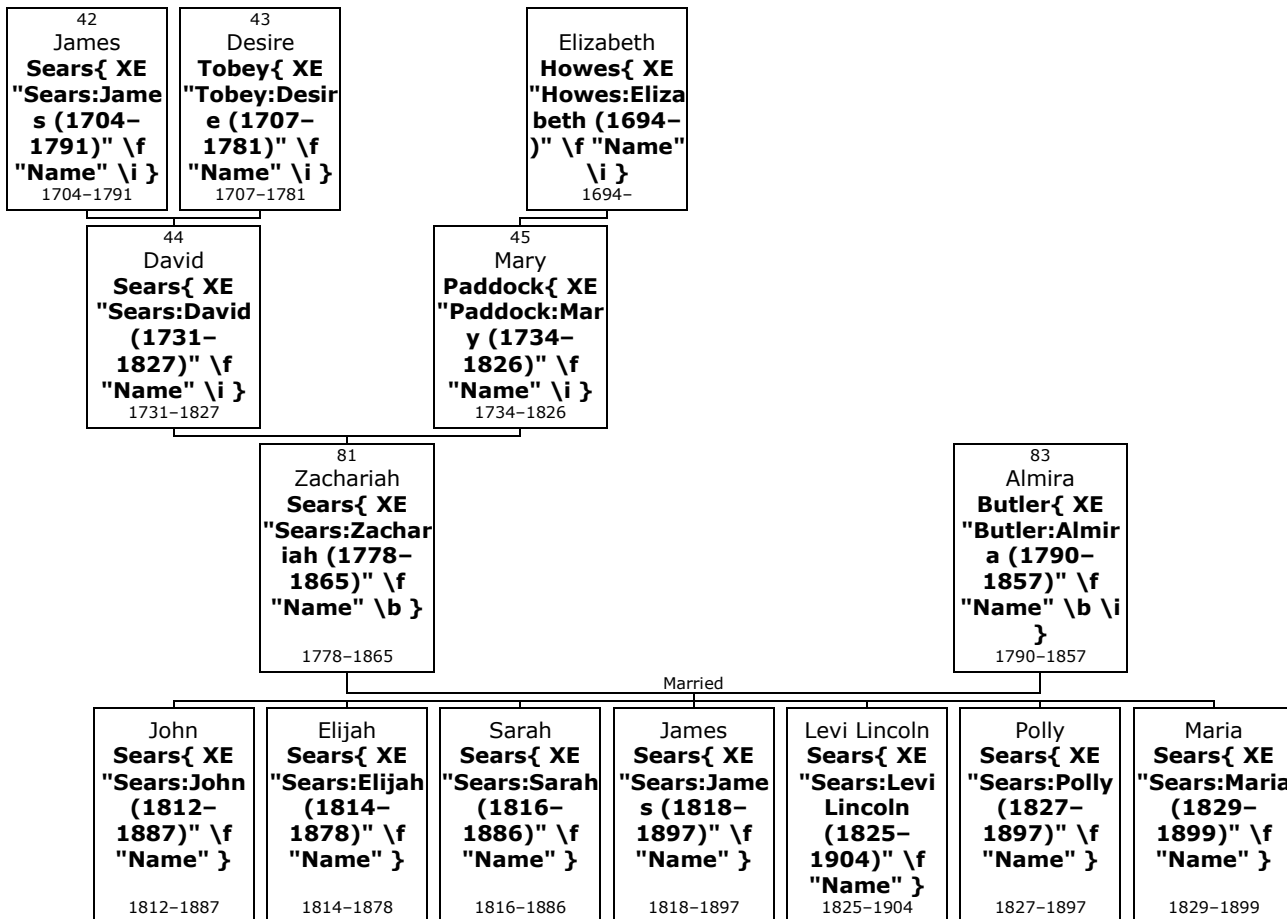

Here are the details about **Zachariah Sears**{ XE "Sears:Zachariah (1778-1865)" \f "Name" \b } second marriage, with Almira Butler. You can read more about Zachariah on page 105.

83. Zachariah Sears married **Almira Butler**{ XE "Butler:Almira (1790-1857)" \f "Name" \b \i }.^[169, 175] They had seven children: John (1812-1887), Elijah (1814-1878), Sarah (1816-1886), James (1818-1897), Levi (1825-1904), Polly (1827-1897) and Maria (1829-1899).

Almira was born at perhaps in Lenox{ XE "USA, Massachusetts, Berkshire, Lenox:(42.3565° N, 73.2849° W):Butler, Almira (1790-1857)" \f "Place" } in 1790.^[169, 175] She reached 67 years of age and died in Lenox{ XE "USA, Massachusetts, Berkshire, Lenox:(42.3565° N, 73.2849° W):Butler, Almira (1790-

1857)" \f "Place" } on 13th March 1857.^[169, 175] Almira was buried in Lenox{ XE "USA, Massachusetts, Berkshire, Lenox:(42.3565° N, 73.2849° W):Butler, Almira (1790-1857)" \f "Place" }.^[175]

!S.P. May p.273 d. of consumption
!Find A Grave Memorial# 47303365

Birth: 1786 Death: Mar. 12, 1852 Lenox Berkshire County Massachusetts, USA Second wife of Lenox farmer Zachariah Sears; they had two children, Levi Lincoln Sears, who migrated to Lorain County, Ohio, and Polly Mary (Sears) Whitaker. Family links: Children: Levi Lincoln Sears (1825 - 1904)*
*Calculated relationship Burial: New Lenox Cemetery Lenox Berkshire County Massachusetts, USA
Plot: Row 10, Grave 167 Created by: waldonia Record added: Jan 29, 2010

Children of Zachariah Sears and Almira Butler:

m I. **John⁵ Sears**{ XE "Sears:John (1812-1887)" \f "Name" \b } was born in Lenox{ XE "USA, Massachusetts, Berkshire, Lenox:(42.3565° N, 73.2849° W):Sears, John (1812-1887)" \f "Place" } on 3rd December 1812.^[169, 170, 176, 177, 178, 179-180] He died in Litchfield{ XE "USA, Ohio, Medina, Litchfield:(41.1678° N, 82.0231° W):Sears, John (1812-1887)" \f "Place" } on 16th August 1887, at the age of 74.^[169, 176]

More facts and events for John Sears:

Residence: 1850 Litchfield{ XE "USA, Ohio, Medina, Litchfield:(41.1678° N, 82.0231° W):Sears, John (1812-1887)" \f "Place" }^[177]

Residence: 1870 Litchfield{ XE "USA, Ohio, Medina, Litchfield:(41.1678° N, 82.0231° W):Sears, John (1812-1887)" \f "Place" }^[178]
Residence Post Office: Litchfield

At the age of 24, John married **Martha Thacher**{ XE "Thacher:Martha (1815-1887)" \f "Name" \b \i } on Thursday, 16th February 1837, in Lee, Berkshire, Massachusetts,{ XE "USA, Massachusetts, Berkshire, Lee:(42.3043° N, 73.2482° W):Sears, John (1812-1887)" \f "Place" } when she was 22 years old.^[169, 170, 176, 178-180] They had six children: Samuel (1838-1908), Betsy (1840-1841), Ada (1843-1914), Fannie (1846-1882), John (1848-1921) and Edward (1851-).

Martha was born at perh in Lee{ XE "USA, Massachusetts, Berkshire, Lee:(42.3043° N, 73.2482° W):Thacher, Martha (1815-1887)" \f "Place" } on Sunday, 5th February 1815.^[169, 176, 178] She was the daughter of Timothy Thacher{ XE "Thacher:Timothy" \f "Name" \i } and Doratha Phelps{ XE "Phelps:Doratha" \f "Name" \i }.

Martha reached 72 years of age and died in Litchfield{ XE "USA, Ohio, Medina, Litchfield:(41.1678° N, 82.0231° W):Thacher, Martha (1815-1887)" \f "Place" } on 12th June 1887.

m II. **Elijah Sears**{ XE "Sears:Elijah (1814-1878)" \f "Name" \b } was born in Lenox{ XE "USA, Massachusetts, Berkshire, Lenox:(42.3565° N, 73.2849° W):Sears, Elijah (1814-1878)" \f "Place" } in 1814.^[181] He died in East Detroit, Macomb, Michigan,{ XE "USA, Michigan, Macomb, East Detroit:(42.4657° N, 82.946° W):Sears, Elijah (1814-1878)" \f "Place" } on 7th February 1878, at the age of 64.

More facts and events for Elijah Sears:

Residence: 1865 Lenox, Berkshire, Massachusetts{ XE "USA, Massachusetts,

¹⁷⁶ Ancestry.com, North America, Family Histories, 1500-2000 (Provo, UT, USA, Ancestry.com Operations, Inc., 2016), Ancestry.com, Book Title: Peabody Genealogy. Record for Julia Frances Sears.
<http://search.ancestry.com/cgi-bin/sse.dll?db=61157&h=2954884&indiv=try>.

¹⁷⁷ Ancestry.com, 1850 United States Federal Census (Provo, UT, USA, Ancestry.com Operations, Inc., 2009), Ancestry.com, Year: 1850; Census Place: Litchfield, Medina, Ohio; Roll: M432_709; Page: 440B; Image: 583.

¹⁷⁸ Ancestry.com, 1870 United States Federal Census (Provo, UT, USA, Ancestry.com Operations, Inc., 2009), Ancestry.com, Year: 1870; Census Place: Litchfield, Medina, Ohio; Roll: M593_1241; Page: 331A; Family History Library Film: 552740.

¹⁷⁹ Ancestry.com, Ohio, County Marriages, 1774-1993 (Lehi, UT, USA, Ancestry.com Operations, Inc., 2016), Ancestry.com.

¹⁸⁰ Dodd, Jordan, Liahona Research, comp, Massachusetts, Marriages, 1633-1850 (Provo, UT, USA, Ancestry.com Operations Inc, 2005), Ancestry.com.

¹⁸¹ Ancestry.com, Massachusetts, State Census, 1865 (Provo, UT, USA, Ancestry.com Operations, Inc., 2014), Ancestry.com.

Berkshire, Lenox:(42.3565° N, 73.2849° W):Sears, Elijah (1814–1878)" \f "Place" }^[181]
 Marital Status: Married

Elijah Sears married **Matilda French**{ XE "French:Matilda (1823–1890)" \f "Name" \b \i } on Wednesday, 23rd December 1840, in Lenox{ XE "USA, Massachusetts, Berkshire, Lenox:(42.3565° N, 73.2849° W):Sears, Elijah (1814–1878)" \f "Place" }. They had three children: Zilpha (ca.1842–1896), Allen (1845–1900) and Chauncey (1850–1920).

Matilda was born in Norfolk, Litchfield, Connecticut,{ XE "USA, Connecticut, Litchfield, Norfolk:(41.9939° N, 73.2025° W):French, Matilda (1823–1890)" \f "Place" } in 1823. She reached 67 years of age and died on 8th December 1890.

- f III. **Sarah Sears**{ XE "Sears:Sarah (1816–1886)" \f "Name" \b } was born in Lenox{ XE "USA, Massachusetts, Berkshire, Lenox:(42.3565° N, 73.2849° W):Sears, Sarah (1816–1886)" \f "Place" } in 1816. She died in 1886 at the age of 70.

Sarah married **John Parker**{ XE "Parker:John" \f "Name" \b \i }.

- m IV. **James Sears**{ XE "Sears:James (1818–1897)" \f "Name" \b } was born in Lenox{ XE "USA, Massachusetts, Berkshire, Lenox:(42.3565° N, 73.2849° W):Sears, James (1818–1897)" \f "Place" } in 1818.^[168, 170, 180] He died in Pittsfield{ XE "USA, Massachusetts, Berkshire, Pittsfield:(42.4501° N, 73.2454° W):Sears, James (1818–1897)" \f "Place" } on 2nd December 1897, at the age of 79.^[168, 170]

James married **Lydia C Merrell**{ XE "Merrell:Lydia C (1809–)" \f "Name" \b \i } on Tuesday, 11th October 1842, in Lee{ XE "USA, Massachusetts, Berkshire, Lee:(42.3043° N, 73.2482° W):Sears, James (1818–1897)" \f "Place" }.^[180, 182] They had one son: James (1846–1918).

She was baptised in New Hartford, Litchfield, Connecticut,{ XE "USA, Connecticut, Litchfield, New Hartford:(41.8822° N, 72.9775° W):Merrell, Lydia C (1809–)" \f "Place" } in 1808.^[182] Lydia C was born at perhaps in Lenox{ XE "USA, Massachusetts, Berkshire, Lenox:(42.3565° N, 73.2849° W):Merrell, Lydia C (1809–)" \f "Place" } in 1809. She was the daughter of Jerad Merrell{ XE "Merrell:Jerad" \f "Name" \i }.

- m V. **Levi Lincoln Sears**{ XE "Sears:Levi Lincoln (1825–1904)" \f "Name" \b } was born in Lenox{ XE "USA, Massachusetts, Berkshire, Lenox:(42.3565° N, 73.2849° W):Sears, Levi Lincoln (1825–1904)" \f "Place" } on 8th April 1825.^[170, 175, 183] He died in Elyria, Lorain County,{ XE "USA, Ohio, Lorain County, Elyria:(41.3684° N, 82.1077° W):Sears, Levi Lincoln (1825–1904)" \f "Place" } in 1904 at the age of 78.^[175] Levi Lincoln was buried in Elyria{ XE "USA, Ohio, Lorain County, Elyria:(41.3684° N, 82.1077° W):Sears, Levi Lincoln (1825–1904)" \f "Place" }.^[175]

More facts and events for Levi Lincoln Sears:

Residence: 1900 Ward 2, Elyria, Lorain{ XE "USA, Ohio, Lorain, Elyria, Ward 2: :Sears, Levi Lincoln (1825–1904)" \f "Place" }^[183]
 Marital Status: Married; Relation to Head: Head

Levi Lincoln Sears married **Sarah W Schofield**{ XE "Schofield:Sarah W (1827–1856)" \f "Name" \b \i } on Wednesday, 8th November 1848, in Lee, Berkshire, Massachusetts{ XE "USA, Massachusetts, Berkshire, Lee:(42.3043° N, 73.2482° W):Sears, Levi Lincoln (1825–1904)" \f "Place" }.^[170, 175] They had two sons: John (1850–) and George (1854–1918).

Sarah W was born in perh, Lee,{ XE "USA, Massachusetts, Berkshire, Lee, perh: :Schofield, Sarah W (1827–1856)" \f "Place" } in 1827. She reached 29 years of age and died in Lenox{ XE "USA, Massachusetts, Berkshire, Lenox:(42.3565° N, 73.2849° W):Schofield, Sarah W (1827–1856)" \f "Place" } on 18th November 1856. Sarah W was

¹⁸² Ancestry.com, Connecticut, Church Record Abstracts, 1630-1920 (Provo, UT, USA, , 2013), Ancestry.com. [Source citation includes one media item]

¹⁸³ Ancestry.com, 1900 United States Federal Census (Provo, UT, USA, Ancestry.com Operations Inc, 2004), Ancestry.com, Year: 1900; Census Place: Elyria Ward 2, Lorain, Ohio; Roll: 1294; Page: 11B; Enumeration District: 0079; FHL microfilm: 1241295.

buried in Lenox{ XE "USA, Massachusetts, Berkshire, Lenox:(42.3565° N, 73.2849° W):Schofield, Sarah W (1827-1856)" \f "Place" }.^[175]

Levi Lincoln Sears married **Charlotte M Schofield**{ XE "Schofield:Charlotte M (1836-)" \f "Name" \b \i } on Friday, 29th January 1858, in Lenox{ XE "USA, Massachusetts, Berkshire, Lenox:(42.3565° N, 73.2849° W):Sears, Levi Lincoln (1825-1904)" \f "Place" }.^[183] They had one daughter: Lillian (1867-1950).

Charlotte M was born in Andover, Essex,{ XE "USA, Massachusetts, Essex, Andover:(42.6584° N, 71.137° W):Schofield, Charlotte M (1836-)" \f "Place" } in September 1836.^[183]

- f VI. **Polly Sears**{ XE "Sears:Polly (1827-1897)" \f "Name" \b } was born in Lenox{ XE "USA, Massachusetts, Berkshire, Lenox:(42.3565° N, 73.2849° W):Sears, Polly (1827-1897)" \f "Place" } in 1827. She died in 1897 at the age of 70.

Polly married **(unknown given name) Whitaker**{ XE "Whitaker:(unknown given name)" \f "Name" \b \i }.

- f VII. **Maria Sears**{ XE "Sears:Maria (1829-1899)" \f "Name" \b } was born in Lenox{ XE "USA, Massachusetts, Berkshire, Lenox:(42.3565° N, 73.2849° W):Sears, Maria (1829-1899)" \f "Place" } in 1829. She died in 1899 at the age of 70.

Family of James Crosby and Deborah Paddock{ TC "James Crosby and Deborah Paddock" \I 3 \f C}

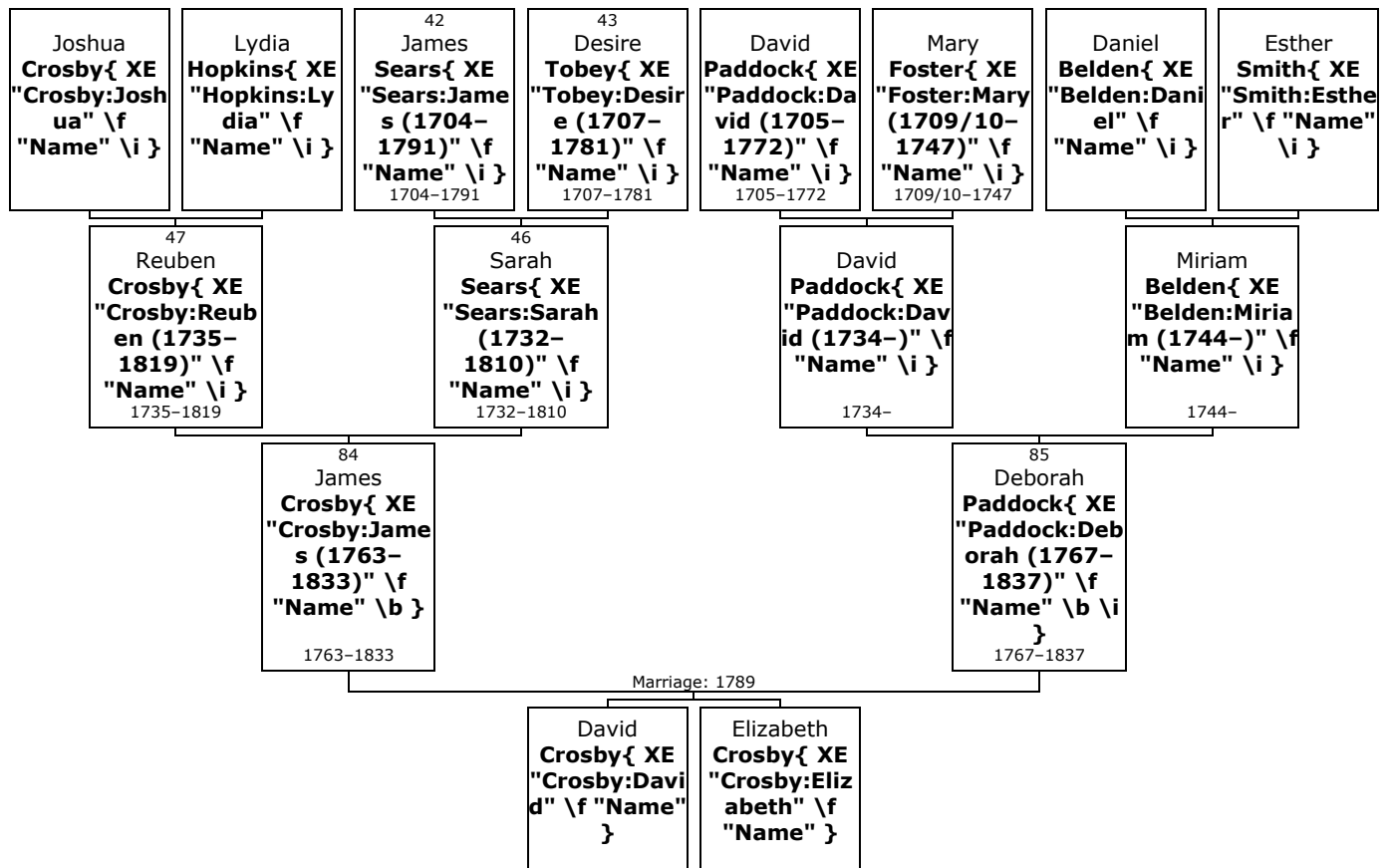

- 84. **James⁴ Crosby**{ XE "Crosby:James (1763-1833)" \f "Name" \b } (*Sarah³ Sears, James²*) was born in 1763 in Putnam, New York, USA{ XE "USA, New York, Putnam:(41.4314° N, 73.7464° W):Crosby, James (1763-1833)" \f "Place" }. He was the son of Reuben Crosby{ XE "Crosby:Reuben (1735-1819)" \f "Name" \i } (47) and Sarah Sears{ XE "Sears:Sarah (1732-1810)" \f "Name" \i } (46).

James died in 1833 at the age of 70.

- 85. James married **Deborah Paddock**{ XE "Paddock:Deborah (1767-1837)" \f "Name" \b \i } in 1789. They had two children: David and Elizabeth.

Deborah was born on Tuesday, 27th October 1767. She was the daughter of David Paddock{ XE "Paddock:David (1734-)\" \f "Name" \i } and Miriam Belden{ XE "Belden:Miriam (1744-)\" \f "Name" \i }.

Deborah reached 70 years of age and died on 21st November 1837.

Children of James Crosby and Deborah Paddock:

- m I. **David⁵ Crosby**{ XE "Crosby:David" \f "Name" \b }.
 David married **Miriam Belden**{ XE "Belden:Miriam" \f "Name" \b \i }.
- f II. **Elizabeth Crosby**{ XE "Crosby:Elizabeth" \f "Name" \b }.
 Elizabeth married **Stephen Perry**{ XE "Perry:Stephen" \f "Name" \b \i }.

Family of Tertullus Crosby and Elizabeth Jones{ TC "Tertullus Crosby and Elizabeth Jones" \I 3 \f C}

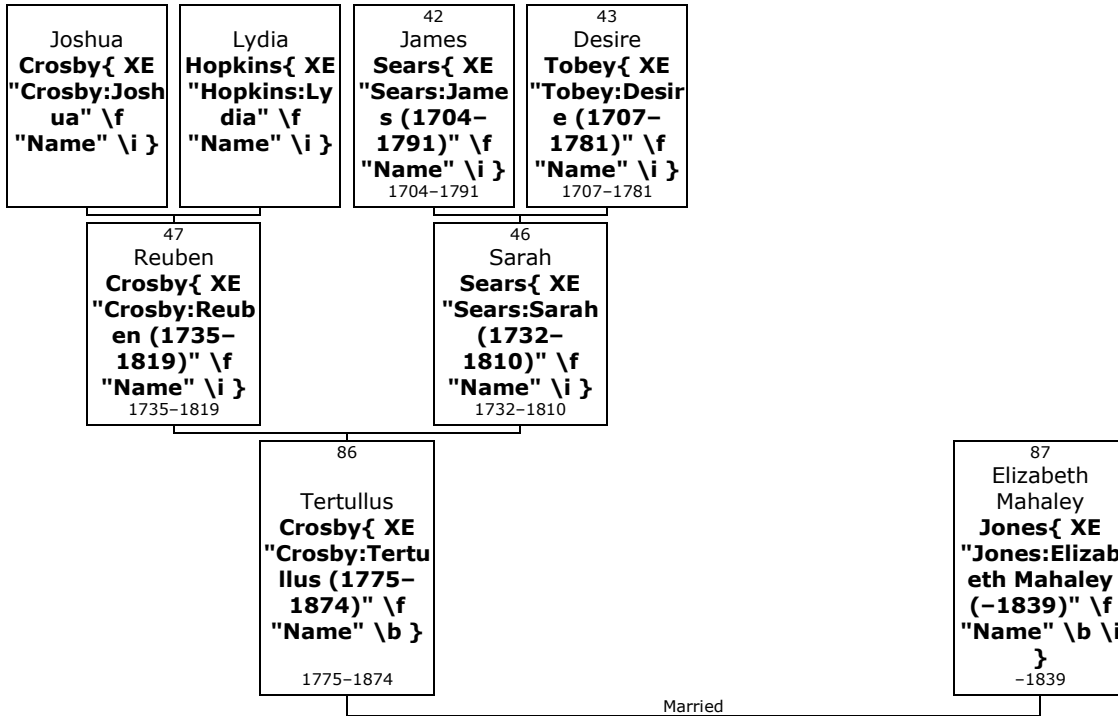

- 86. Tertullus⁴ Crosby**{ XE "Crosby:Tertullus (1775-1874)" \f "Name" \b } (*Sarah³ Sears, James²*) was born on Thursday, 2nd February 1775, in Patterson, Putnam, New York, USA{ XE "USA, New York, Putnam, Patterson:(41.5136° N, 73.6067° W):Crosby, Tertullus (1775-1874)" \f "Place" }. He was the son of Reuben Crosby{ XE "Crosby:Reuben (1735-1819)" \f "Name" \i } (47) and Sarah Sears{ XE "Sears:Sarah (1732-1810)" \f "Name" \i } (46).

Tertullus died in Troy, Newaygo, Michigan,{ XE "USA, Michigan, Newaygo, Troy:(43.7431° N, 86.0192° W):Crosby, Tertullus (1775-1874)" \f "Place" } on 14th September 1874, at the age of 99.

!http://trees.ancestry.com/owt/person.aspx?pid=11591814

- 87.** Tertullus married **Elizabeth Mahaley Jones**{ XE "Jones:Elizabeth Mahaley (-1839)" \f "Name" \b \i } in Patterson, Putnam, New York{ XE "USA, New York, Putnam, Patterson:(41.5136° N, 73.6067° W):Crosby, Tertullus (1775-1874)" \f "Place" }. They had no known children.

Elizabeth Mahaley died on 29th June 1839.

Family of Mary Foster and Obadiah Crosby{ TC "Mary Foster and Obadiah Crosby" \I 3 \f C}

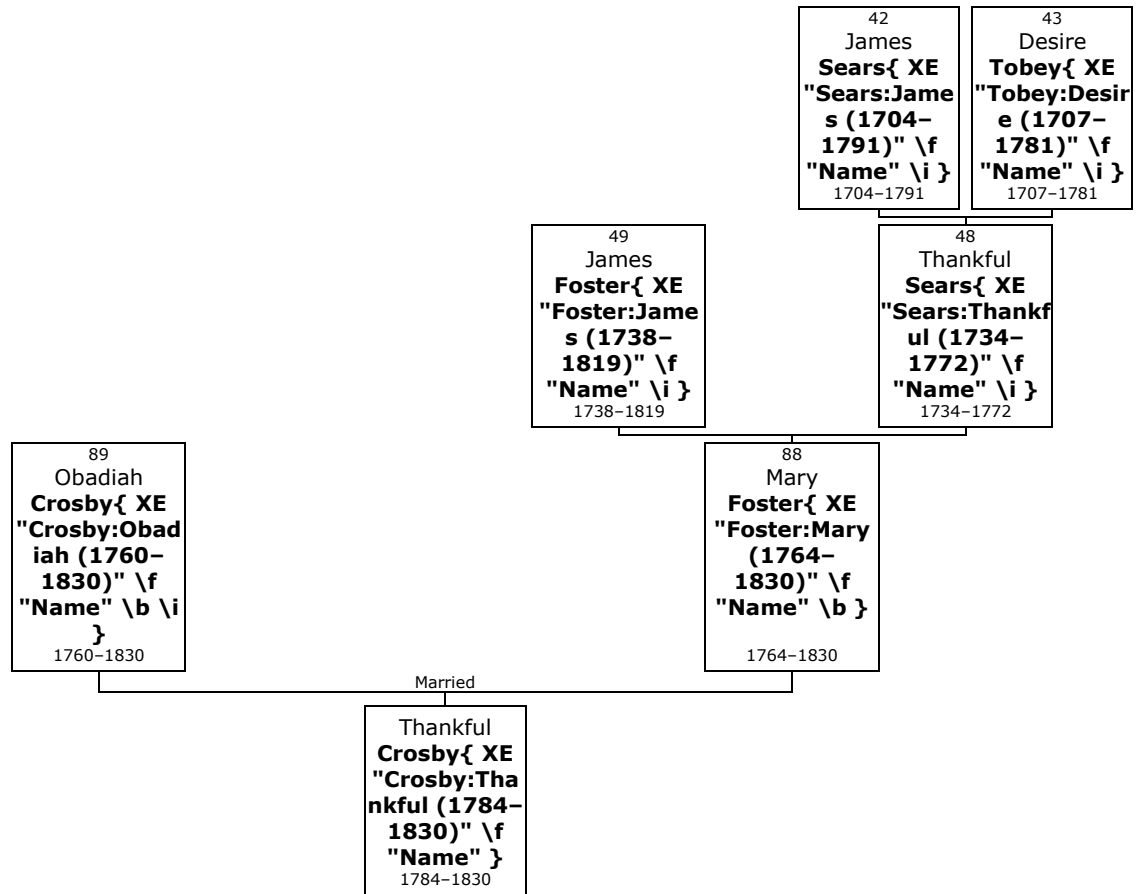

88. **Mary⁴ Foster**{ XE "Foster:Mary (1764-1830)" \f "Name" \b } (*Thankful³ Sears, James²*) was born in 1764 in perh, Yarmouth, Barnstable, Massachusetts, USA{ XE "USA, Massachusetts, Barnstable, Yarmouth, perh: :Foster, Mary (1764-1830)" \f "Place" }. She was the daughter of James Foster{ XE "Foster:James (1738-1819)" \f "Name" \i } (49) and Thankful Sears{ XE "Sears:Thankful (1734-1772)" \f "Name" \i } (48).

Mary died in 1830 at the age of 66.

!PA001 - J Kelsey Jones

89. She married **Obadiah Crosby**{ XE "Crosby:Obadiah (1760-1830)" \f "Name" \b \i }. They had one daughter: Thankful (1784-1830).

Obadiah was born in 1760. He reached 70 years of age and died in 1830.

!PA001 - J Kelsey Jones

Daughter of Mary Foster and Obadiah Crosby:

f I. **Thankful⁵ Crosby**{ XE "Crosby:Thankful (1784-1830)" \f "Name" \b } was born in 1784. She died in 1830 at the age of 46.

Thankful married **Oliver Noble**{ XE "Noble:Oliver (1780-1839)" \f "Name" \b \i }. They had one son: Alonzo (1808-1900).

Oliver was born in 1780. He reached 59 years of age and died in 1839.

!PA001 J Kelsey Jones born in 178x

Family of Enoch Sears and Smith{ TC "Enoch Sears and Smith" \l 3 \f C}

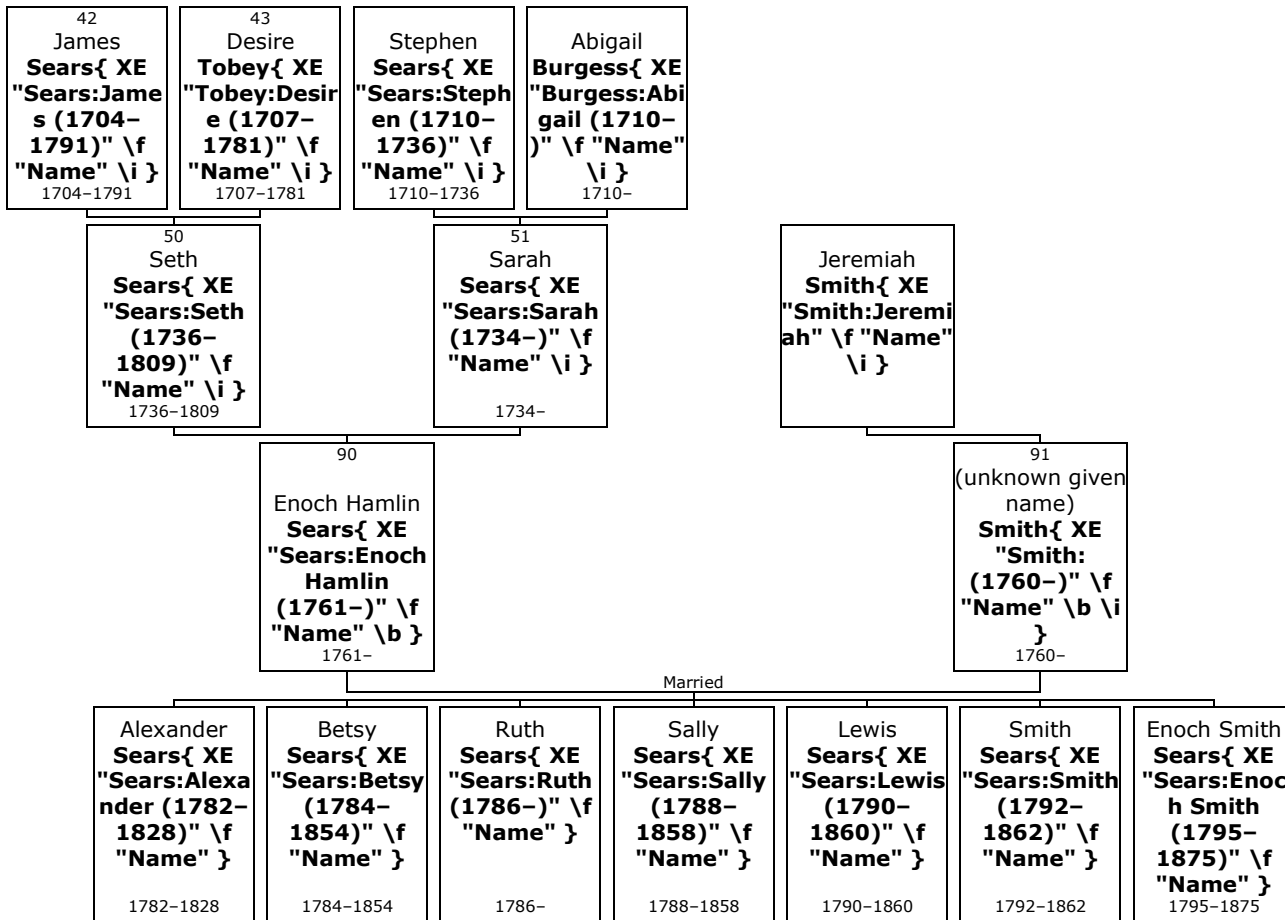

90. **Enoch Hamlin⁴ Sears**{ XE "Sears:Enoch Hamlin (1761-)" \f "Name" \b } (*Seth³, James²*) was born in 1761 in Southeast, Putnam, New York, USA{ XE "USA, New York, Putnam, Southeast:(41.4054° N, 73.6001° W):Sears, Enoch Hamlin (1761-)" \f "Place" }. He was the son of Seth Sears{ XE "Sears:Seth (1736-1809)" \f "Name" \i } (50) and Sarah Sears{ XE "Sears:Sarah (1734-)" \f "Name" \i } (51).

May, Samuel. The Descendants of Richard Sares (Sears) of Yarmouth, Mass., 1638-1888 Page 274 (Joel Munsell's Sons, 1890) No 747

<https://www.wikitree.com/wiki/Sears-4779>

!Ruth G Pickard - The records of the Presbyterian Church at Ballston abound in the names of the progeny of Enoch Hamlin Sears

!

!Heidi Brewer Detty Enoch Smith Sears was my great(4th power) grandfather who came to Morrow county, Ohio in 1834 from Duches County New York. From the online research that I have done I believe that he is the son of Enoch Hamlin Sears who was also of Duches County New York. Enoch Hamlin Sears had a son Smith Sears who I have found listed with the same date of birth as my great relative. Online they state that Smith Sears went west with some family members and was never heard of again. I feel pretty confident that Enoch Smith Sears is his son. In an 1830 census an Enoch Sears is listed in Albion, New York which is west of Duches County. I could not find him listed in a later census in New York. Enoch Hamlin Sears? wife was identified as Lewis Sears. Enoch Hamlin Sears and Lewis Sears named a son Lewis Sears but he died in childhood. When my great (4) grandfather had children he named one of his sons Lewis Sears. I think this is further evidence that Lewis Sears was his mother. The name Smith Sears is also used in the family again by Enoch Smith Sears? grandson. I believe that either the online sites do not list his full name or he adopted his father's first name.

I am fairly new at this family research. Does anyone have ideas as to how I might go about proving that Enoch Smith Sears is the son of Enoch Hamlin Sears? Enoch Smith Sears and Laura Marvin Sears are also listed as being married in Duches county New York. Any ideas for locating the marriage entry. I suppose

that would be a good way to prove. I appreciate any help. July 27 at 1:51pm Heidi Brewer Detty Richard-Silas-Silas-James-Seth-Enoch Hamlin-Enoch Smith-Aaron Burr-George Forest-Oral Blaine-Hubert Blaine-Jeannette Arlene Sears. <http://www.facebook.com/profile.php?id=1417112756>

91. He married **(unknown given name) Smith**{ XE "Smith: (1760-)" \f "Name" \b \i }. They had seven children: Alexander (1782-1828), Betsy (1784-1854), Ruth (1786-), Sally (1788-1858), Lewis (1790-1860), Smith (1792-1862) and Enoch (1795-1875).
- (unknown given name) was born in perh, Southeast,{ XE "USA, New York, Putnam, Southeast, perh: :Smith, (1760-)" \f "Place" } in 1760. She was the daughter of Jeremiah Smith{ XE "Smith:Jeremiah" \f "Name" \i }.

Children of Enoch Hamlin Sears and (unknown given name) Smith:

- m I. **Alexander⁵ Sears**{ XE "Sears:Alexander (1782-1828)" \f "Name" \b } was born in Ballston, Saratoga,{ XE "USA, New York, Saratoga, Ballston:(42.9548° N, 73.879° W):Sears, Alexander (1782-1828)" \f "Place" } on 9th August 1782.^[184, 185] He died in Saratoga{ XE "USA, New York, Saratoga:(43.1059° N, 73.8677° W):Sears, Alexander (1782-1828)" \f "Place" } on 6th October 1828, at the age of 46.^[184, 185] Alexander was buried in Crapo Cemetery, Saratoga{ XE "USA, New York, Saratoga, Crapo Cemetery: :Sears, Alexander (1782-1828)" \f "Place" }.^[184]
- 
- Alexander
- Alexander married **Mary Howes**{ XE "Howes:Mary (1785-1874)" \f "Name" \b \i } in 1802.^[184, 185] They had eight children: David (1803-1806), Ruth (1805-1808), Lewis (1808-1887), Henry (1810-1861), Epenetus (1815-1881), Alexander (1818-1905), Isaac (1821-1915) and Mary (1825-).
- Mary was born in Saratoga{ XE "USA, New York, Saratoga:(43.1059° N, 73.8677° W):Howes, Mary (1785-1874)" \f "Place" } on Monday, 24th October 1785.^[184, 185]
- She was the daughter of David Howes{ XE "Howes:David (1759-)" \f "Name" \i }. Mary reached 88 years of age and died in Saratoga{ XE "USA, New York, Saratoga:(43.1059° N, 73.8677° W):Howes, Mary (1785-1874)" \f "Place" } on 13th April 1874.^[184, 185] She was buried in Crapo Cemetery, Saratoga{ XE "USA, New York, Saratoga, Crapo Cemetery: :Howes, Mary (1785-1874)" \f "Place" }.^[184]
- Sears Mary Wife of Alexander Sears 1874/04/13 87y Crapo Cemetry Recorded by C.Durkee - 1878. Burnt Hills Calvary Episcopal Church Cemetery
- f II. **Betsy Sears**{ XE "Sears:Betsy (1784-1854)" \f "Name" \b } was born in perh, Southeast, Putnam,{ XE "USA, New York, Putnam, Southeast, perh: :Sears, Betsy (1784-1854)" \f "Place" } in 1784. She died in 1854 at the age of 70.
- Betsy Sears married **Jonathan Hedges**{ XE "Hedges:Jonathan" \f "Name" \b \i }. They had three sons: Elias, Henry and William.
- f III. **Ruth Sears**{ XE "Sears:Ruth (1786-)" \f "Name" \b } was born in perh{ XE "USA, New York, Putnam, Southeast, perh: :Sears, Ruth (1786-)" \f "Place" } in 1786.
- Ruth married **Jonathan Curtis**{ XE "Curtis:Jonathan" \f "Name" \b \i }.
- f IV. **Sally Sears**{ XE "Sears:Sally (1788-1858)" \f "Name" \b } was born in perh{ XE "USA, New York, Putnam, Southeast, perh: :Sears, Sally (1788-1858)" \f "Place" } in 1788. She died in 1858 at the age of 70.
- Sally married **(unknown given name) Pierson**{ XE "Pierson:(unknown given name)" \f "Name" \b \i }.
- m V. **Lewis Sears**{ XE "Sears:Lewis (1790-1860)" \f "Name" \b } was born in perh{ XE "USA, New York, Putnam, Southeast, perh: :Sears, Lewis (1790-1860)" \f "Place" } in 1790. He died in 1860 at the age of 70.

¹⁸⁴ Ancestry.com, U.S., Find A Grave Index, 1600s-Current (Provo, UT, USA, Ancestry.com Operations, Inc., 2012), Ancestry.com.

¹⁸⁵ Ancestry.com, North America, Family Histories, 1500-2000 (Provo, UT, USA, Ancestry.com Operations, Inc., 2016), Ancestry.com, Book Title: Lineage Book : NSDAR : Volume 113 : 1914.

m VI. **Smith Sears**{ XE "Sears:Smith (1792-1862)" \f "Name" \b } was born in perh{ XE "USA, New York, Putnam, Southeast, perh: :Sears, Smith (1792-1862)" \f "Place" } in 1792. He died in 1862 at the age of 70.

m VII. **Enoch Smith Sears**{ XE "Sears:Enoch Smith (1795-1875)" \f "Name" \b } was born in New York{ XE "USA, New York:(42.7531° N, 74.2224° W):Sears, Enoch Smith (1795-1875)" \f "Place" } on 9th August 1795.^[184] He died in Morrow, Ohio,{ XE "USA, Ohio, Morrow:(40.5259° N, 82.798° W):Sears, Enoch Smith (1795-1875)" \f "Place" } on 12th August 1875, at the age of 80.^[184] Enoch Smith was buried in Bloomfield, Morrow{ XE "USA, Ohio, Morrow, Bloomfield: :Sears, Enoch Smith (1795-1875)" \f "Place" }.^[184]



Enoch

Enoch Smith married **Laura Marvin**{ XE "Marvin:Laura (1796-1871)" \f "Name" \b \i } in 1816.^[184] They had six children: Floyd (1817-1893), Aaron (1828-1910), Rufus (1831-1915), Lewis, George and Harriet.

Laura was born in Dutchess, New York,{ XE "USA, New York, Dutchess:(41.7645° N, 73.7472° W):Marvin, Laura (1796-1871)" \f "Place" } on Sunday, 15th May 1796.^[184] She reached 75 years of age and died in Morrow, Ohio,{ XE "USA, Ohio, Morrow:(40.5259° N, 82.798° W):Marvin, Laura (1796-1871)" \f "Place" } on 29th December 1871.^[184] Laura was buried in Bloomfield, Morrow{ XE "USA, Ohio, Morrow, Bloomfield: :Marvin, Laura (1796-1871)" \f "Place" }.^[184]

Family of Naomi Sears and Zadoc(k) Rider{ TC "Naomi Sears and Zadoc(k) Rider" \I 3 \f C}

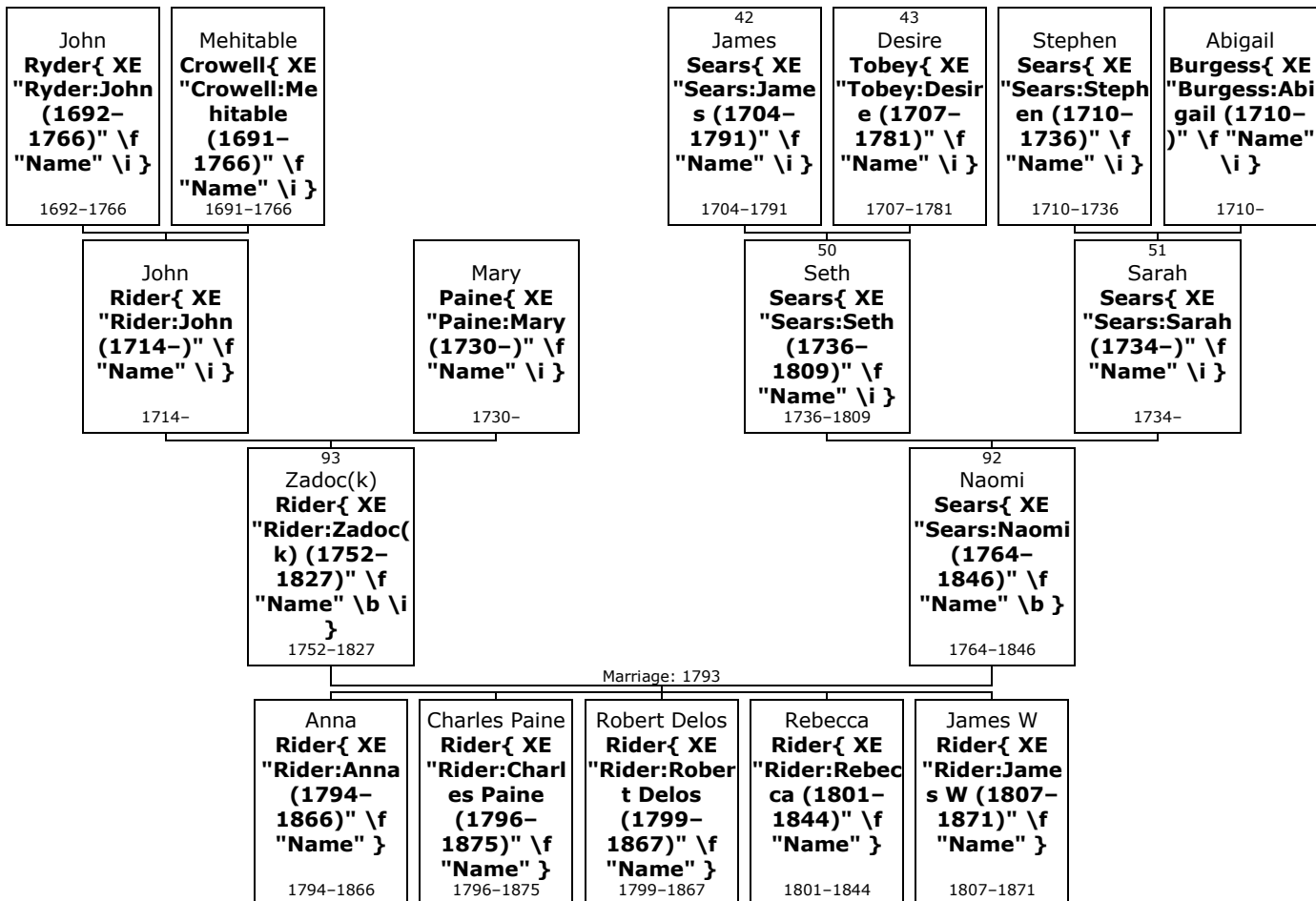

92. Naomi⁴ Sears{ XE "Sears:Naomi (1764-1846)" \f "Name" \b } (*Seth³, James²*) was born on Sunday, 23rd September 1764, in prob, Southeast, Putnam, New York, USA{ XE "USA, New York, Putnam, Southeast, prob: :Sears, Naomi (1764-1846)" \f "Place" }. She was the daughter of Seth Sears{ XE "Sears:Seth (1736-1809)" \f "Name" \i } (50) and Sarah Sears{ XE "Sears:Sarah (1734-)" \f "Name" \i } (51).

Naomi died in Winfield, Herkimer, { XE "USA, New York, Herkimer, Winfield:(42.8973° N, 75.1663° W):Sears, Naomi (1764–1846)" \f "Place" } on 30th March 1846, at the age of 81. She was buried in North Winfield, Winfield { XE "USA, New York, Herkimer, Winfield, North Winfield: :Sears, Naomi (1764–1846)" \f "Place" }.

<https://www.wikitree.com/wiki/Sears-4780>

!Ruth G Pickard The search for Naomi Sears' parents has been long and frustrating. She is clearly referred to in two separate Bible records as the wife of Zadock Rider. Her birth is recorded as 23 Sep 1764. Her father is most certainly Seth Sears. In regard to the family of Seth and Sarah (Sears) Sears in the May Genealogy, there are several discrepancies. First of all, there is a tremendous gap between the birth of their first child Enoch Hamlin ca. 1760 and the birth of their next listed child, Seth, to whom Samuel May assigns a ca. 1771 birthdate. A record of the family of Seth Sears, Jr., formerly in possession of Porter Barrows of Sherburne, NY, and published by the James Madison Chapter, DAR (NY DAR Church Cemetery and Town Records v. 123, p.88), says Seth Sears 3rd was born in South East Town, Dutchess County, State of New York, August 11th 176__ (page torn). Ruamy Andress was born in Greenfield, Fairfield co, CT, 24 Jan 17__ (Page torn). Although the date of Seth's birth is incomplete, it obviously did not take place in 1771, as May surmises. The Foster-Livingston Collection of Putnam co Records quotes the tombstone inscription in Milltown Cemetery as follows: "The graves of Seth and Rheuhamah, he died May 1, 1819, 48 y, and she died Dec 9, 1813, 31y." This is the apparent source of May's 1771 birthdate. However, the Bible fragment referred to above is at odds with the date on the tombstone and gives Seth's death date as May 1, 1817. This accords with the date on which his will was entered into probate-- 16 May 1817. If Seth was indeed 48 years old when he died, he would have to have been born in 1769 and not 1771. This leaves Seth and Sarah's "third" child Eleazar H. with a birthdate of 1771, which seems entirely reasonable. Sarah Sears, their "fourth" child, has no birthdate assigned, and their last child, Thankful, about whom a considerable amount of accurate information is given, was born on 30 Jun 1775. In regard to the birthdate of Sarah, the International Genealogical Index, published by the LDS Church, gives a birthdate of 24 Mar 1767, for Sarah Sears but does not assign her any parents. A marriage to Thomas Randall in November, 1787, is also listed for Sarah Sears, but again no parents are listed. However, it seems likely that this is Seth's daughter. If the family births are arranged according to the information given above, we arrive at a much more reasonable birth order and spacing than the one given by May.

!

!BURIED: Cemetery (abandoned)

- 93.** Naomi married **Zadoc(k) Rider** { XE "Rider:Zadoc(k) (1752–1827)" \f "Name" \b \i } in 1793. They had five children: Anna (1794–1866), Charles (1796–1875), Robert (1799–1867), Rebecca (1801–1844) and James (1807–1871).

Zadoc(k) was born in was Dutchess, Southeast, Putnam, { XE "USA, New York, Putnam, Southeast, was Dutchess: :Rider, Zadoc(k) (1752–1827)" \f "Place" } on 10th June 1752. He was the son of John Rider { XE "Rider:John (1714–)" \f "Name" \i } and Mary Paine { XE "Paine:Mary (1730–)" \f "Name" \i }.

Zadoc(k) reached 75 years of age and died in Winfield, Herkimer, { XE "USA, New York, Herkimer, Winfield:(42.8973° N, 75.1663° W):Rider, Zadoc(k) (1752–1827)" \f "Place" } on 23rd June 1827.

Children of Naomi Sears and Zadoc(k) Rider:

- f I. **Anna⁵ Rider** { XE "Rider:Anna (1794–1866)" \f "Name" \b } was born in was Dutchess, Southeast, Putnam, { XE "USA, New York, Putnam, Southeast, was Dutchess: :Rider, Anna (1794–1866)" \f "Place" } on 11th June 1794. She died in prob, Litchfield, Herkimer Co, { XE "USA, New York, Herkimer Co, Litchfield, prob: :Rider, Anna (1794–1866)" \f "Place" } on 25th October 1866, at the age of 72.
- m II. **Charles Paine Rider** { XE "Rider:Charles Paine (1796–1875)" \f "Name" \b } was born in Litchfield, Herkimer, { XE "USA, New York, Herkimer, Litchfield:(42.9776° N, 75.1507° W):Rider, Charles Paine (1796–1875)" \f "Place" } on 3rd August 1796. He died in Cassville, Oneida, { XE "USA, New York, Oneida, Cassville:(42.9458° N, 75.2547° W):Rider, Charles Paine (1796–1875)" \f "Place" } on 9th October 1875, at the age of 79.
- Charles Paine married **Rebecca Penny** { XE "Penny:Rebecca (1800–)" \f "Name" \b \i } in 1821 in Henderson, Jefferson { XE "USA, New York, Jefferson, Henderson:(43.8469° N, 76.1822° W):Rider, Charles Paine (1796–1875)" \f "Place" }. They had six children: Ebenezer (1822–), Thankful (1824–), Eliza (1826–), Drusilla (1827–), Pruslia (1831–) and Charles (1837–).

Rebecca was born in perh, Henderson, { XE "USA, New York, Jefferson, Henderson, perh: :Penny, Rebecca (1800–)" \f "Place" } in 1800.

- m III. **Robert Delos Rider**{ XE "Rider:Robert Delos (1799-1867)" \f "Name" \b } was born in Litchfield{ XE "USA, New York, Herkimer, Litchfield:(42.9776° N, 75.1507° W):Rider, Robert Delos (1799-1867)" \f "Place" } on 8th September 1799. He died in Arkwright, Chautauqua,{ XE "USA, New York, Chautauqua, Arkwright:(42.4069° N, 79.2367° W):Rider, Robert Delos (1799-1867)" \f "Place" } on 19th October 1867, at the age of 68.
- Robert Delos Rider married **Lucy Spencer**{ XE "Spencer:Lucy (1801-)" \f "Name" \b \i } on Thursday, 24th January 1822, in Winfield, Herkimer{ XE "USA, New York, Herkimer, Winfield:(42.8973° N, 75.1663° W):Rider, Robert Delos (1799-1867)" \f "Place" }. They had three children: Theron (1822-), Delos (1824-1897) and Sarah (1828-).
- Lucy was born in perh, Winfield, Herkimer Co,{ XE "USA, New York, Herkimer Co, Winfield, perh: :Spencer, Lucy (1801-)" \f "Place" } in 1801.
- Robert Delos Rider married **Mrs Almira Rogers**{ XE "Rogers:Almira (1834-)" \f "Name" \b \i } on Thursday, 22nd November 1855. They had no known children.
- Almira was born in perh, Litchfield, Herkimer,{ XE "USA, New York, Herkimer, Litchfield, perh: :Rogers, Almira (1834-)" \f "Place" } in 1834.
- f IV. **Rebecca Rider**{ XE "Rider:Rebecca (1801-1844)" \f "Name" \b } was born in Litchfield{ XE "USA, New York, Herkimer, Litchfield:(42.9776° N, 75.1507° W):Rider, Rebecca (1801-1844)" \f "Place" } on 31st December 1801. She died in Richfield, Otsego,{ XE "USA, New York, Otsego, Richfield:(42.8572° N, 75.0544° W):Rider, Rebecca (1801-1844)" \f "Place" } on 11th December 1844, at the age of 42.
- Rebecca Rider married **Levi Cole**{ XE "Cole:Levi (1797-)" \f "Name" \b \i } in prob, Winfield, Herkimer Co{ XE "USA, New York, Herkimer Co, Winfield, prob: :Rider, Rebecca (1801-1844)" \f "Place" }. They had four children: Henry (1836-), Tunis (1838-), Charles (1840-) and Rebecca (1842-).
- Levi was born in perh, Litchfield, Herkimer,{ XE "USA, New York, Herkimer, Litchfield, perh: :Cole, Levi (1797-)" \f "Place" } in 1797.
- m V. **James W Rider**{ XE "Rider:James W (1807-1871)" \f "Name" \b } was born in Litchfield{ XE "USA, New York, Herkimer, Litchfield:(42.9776° N, 75.1507° W):Rider, James W (1807-1871)" \f "Place" } on 20th March 1807. He died in prob, Villenova, Chautauqua,{ XE "USA, New York, Chautauqua, Villenova, prob: :Rider, James W (1807-1871)" \f "Place" } on 5th July 1871, at the age of 64. James W was buried. Hamlet Cemetery.
- James W Rider married **Susan --Rider**{ XE "--Rider:Susan (1821-)" \f "Name" \b \i }. They had no known children.
- Susan was born in Litchfield, Herkimer,{ XE "USA, New York, Herkimer, Litchfield:(42.9776° N, 75.1507° W):--Rider, Susan (1821-)" \f "Place" } in 1821.
- James W Rider married **Susannah --Rider**{ XE "--Rider:Susannah (1813-)" \f "Name" \b \i }. They had one son: James (1835-).
- Susannah was born in Litchfield{ XE "USA, New York, Herkimer, Litchfield:(42.9776° N, 75.1507° W):--Rider, Susannah (1813-)" \f "Place" } in 1813.

Family of Sarah Sears and Zacheus Raymond{ TC "Sarah Sears and Zacheus Raymond" \I 3 \f C}

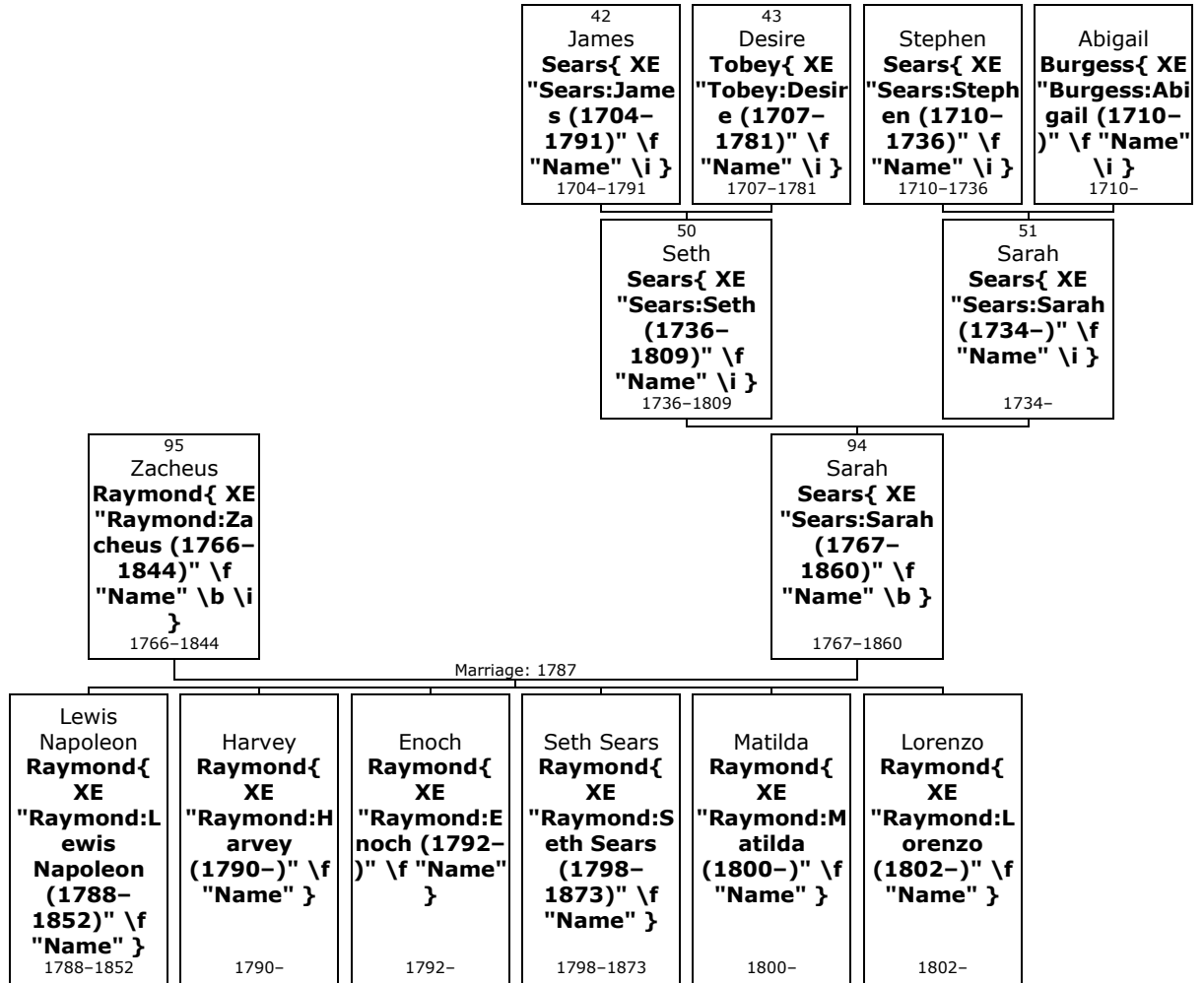

94. Sarah⁴ Sears{ XE "Sears:Sarah (1767-1860)" \f "Name" \b \i } (*Seth*³, *James*²) was born on Tuesday, 24th March 1767, in Southeast, Putnam, New York, USA{ XE "USA, New York, Putnam, Southeast:(41.4054° N, 73.6001° W):Sears, Sarah (1767-1860)" \f "Place" \i }. She was the daughter of Seth Sears{ XE "Sears:Seth (1736-1809)" \f "Name" \i } (50) and Sarah Sears{ XE "Sears:Sarah (1734-)" \f "Name" \i } (51).

Sarah died on 26th September 1860, at the age of 93. She was buried in Columbus, Warren, Pennsylvania{ XE "USA, Pennsylvania, Warren, Columbus:(41.9408° N, 79.582° W):Sears, Sarah (1767-1860)" \f "Place" \i }.

Mrs Charles N (Madeline) Dodd- The 1790 census of Dutchess co, NY shows four families named Sears (Seth, Seth Jr., Benjamin and Stephen). In the 1830 census of Warren co, PA, there was a James Sears living near Zacheus & Sarah Raymond, no connection known. BURIED: Curtis Cemetery

95. Sarah married Zacheus Raymond{ XE "Raymond:Zacheus (1766-1844)" \f "Name" \b \i } in November 1787 in Dutchess, New York{ XE "USA, New York, Dutchess:(41.7645° N, 73.7472° W):Sears, Sarah (1767-1860)" \f "Place" \i }. They had six children: Lewis (1788-1852), Harvey (1790-), Enoch (1792-), Seth (1798-1873), Matilda (1800-) and Lorenzo (1802-).

Zacheus was born in Norwalk, Fairfield, Connecticut,{ XE "USA, Connecticut, Fairfield, Norwalk:(41.1176° N, 73.4079° W):Raymond, Zacheus (1766-1844)" \f "Place" \i } in January 1766. He reached 78 years of age and died in Columbus, Warren, Pennsylvania,{ XE "USA, Pennsylvania, Warren, Columbus:(41.9408° N, 79.582° W):Raymond, Zacheus (1766-1844)" \f "Place" \i } on 9th December 1844.

Madeline Dodd - Samuel Raymond's genealogy shows Zacheus disappearing into Nova Scotia after the War in the write-up under his father, Comfort, yet in Zacheus' own paragraph, he supposedly "lived and died in Chenango co, NY," where his wife "lived to a very advanced age, dying about 1853," and "had two children, Enoch and Lewis." Leach (who update Samuel's work) seemed unaware that Zacheus had ever lived

anywhere but CT and PA. In fact, he was living in Dutchess co, NY on the 1790 census, and was listed in Chenango co, NY in 1810 and 1820. There was a Zachariah Raymond in Herkimer co in 1800, which was the parent county of Chenango and it's almost certain that Zachariah and Zacheus are the same person. In May 1780 Zacheus enlisted in the Continental Army as Private, for a period of three months following which he reenlisted for another three months and again in 1781 for six months and twenty days as a teamster. He was under the command of Capt Couch and Colonel Canfield in the State of CT. At Zacheus' death, he was buried on his own farm on a hillside just off US Rt 6. Since his burial, a large cherry tree has grown above the grave, which is surrounded by a metal fence. BIRTH: Darwin Everett Leach, HISTORY OF ZACHEUS RAYMOND; 1630-1929; Corry, PA, 1932; p 1 ; copy in poss of Ray Sears; The origin of the family name, RAYMOND, dates back to the year 240, before given names were used. It starts with Raymond the 1st, Count of Toulouse, which was long before Germany, France or Spain were separate countries. Richard Raymond and his wife Judith were members of First Church, Salem, MA. In 1660 he sold one quarter part of "THE GOOD KETCH," called the Hopewell of Salem, of the burthen of thirty tons, now being or riding at anchor in the harbor of Boston. 20 October 1662 he purchased a house and land at Norwalk CT. His children were all baptised in the First Church, Salem. The line to Zacheus is not clear bit appears to go John, Thomas, Comfort, Comfort. Little is known of Zacheus' early life which was spent on a farm (in CT). After the war he removed to Columbus, PA where he resided on a farm until his death. DAR was placed on the pension roll of Warren co, PA, 1833 for his service as private, CT militia

Children of Sarah Sears and Zacheus Raymond:

m I. **Lewis Napoleon⁵ Raymond**{ XE "Raymond:Lewis Napoleon (1788-1852)" \f "Name" \b } was born in perh, Dutchess,{ XE "USA, New York, Dutchess, perh: :Raymond, Lewis Napoleon (1788-1852)" \f "Place" } in 1788. He died in Columbus, Warren, Pennsylvania,{ XE "USA, Pennsylvania, Warren, Columbus:(41.9408° N, 79.582° W):Raymond, Lewis Napoleon (1788-1852)" \f "Place" } on 12th September 1852, at the age of 64. Lewis Napoleon was buried in Wheelock, Erie{ XE "USA, Pennsylvania, Erie, Wheelock: :Raymond, Lewis Napoleon (1788-1852)" \f "Place" }.

Lewis Napoleon married **Martha Howard**{ XE "Howard:Martha (1793-1854)" \f "Name" \b \i }. They had seven children: Mary (1816-1862), Lorenzo (1818-1901), Alonzo (1820-1884), Howard (1822-1898), Charles (1824-1885), Martha (1827-1881) and Philip (1833-1909).

Martha was born in Foster, New York,{ XE "USA, New York, Foster: :Howard, Martha (1793-1854)" \f "Place" } on Wednesday, 21st August 1793. She reached 60 years of age and died in Columbus, Warren, Pennsylvania,{ XE "USA, Pennsylvania, Warren, Columbus:(41.9408° N, 79.582° W):Howard, Martha (1793-1854)" \f "Place" } on 24th June 1854. Martha was buried in Wheelock, Erie{ XE "USA, Pennsylvania, Erie, Wheelock: :Howard, Martha (1793-1854)" \f "Place" }.

!BIRTH-CHIDREN-DEATH: Darwin Everett Leach, HISTORY OF ZACHEUS RAYMOND; 1630-1929; Corry, PA, 1932; p 7 ; copy in poss of Ray Sears

m II. **Harvey Raymond**{ XE "Raymond:Harvey (1790-)" \f "Name" \b } was born in perh{ XE "USA, New York, perh: :Raymond, Harvey (1790-)" \f "Place" } in 1790.

m III. **Enoch Raymond**{ XE "Raymond:Enoch (1792-)" \f "Name" \b } was born in perh{ XE "USA, New York, perh: :Raymond, Enoch (1792-)" \f "Place" } in 1792.

Enoch married **Rebecca Stewart**{ XE "Stewart:Rebecca" \f "Name" \b \i }.

m IV. **Seth Sears Raymond**{ XE "Raymond:Seth Sears (1798-1873)" \f "Name" \b } was born in New York{ XE "USA, New York:(42.7531° N, 74.2224° W):Raymond, Seth Sears (1798-1873)" \f "Place" } on 25th April 1798.^[186] He died in Columbus{ XE "USA, Pennsylvania, Warren, Columbus:(41.9408° N, 79.582° W):Raymond, Seth Sears (1798-1873)" \f "Place" } on 23rd September 1873, at the age of 75. Seth Sears was buried in Columbus{ XE "USA, Pennsylvania, Warren, Columbus:(41.9408° N, 79.582° W):Raymond, Seth Sears (1798-1873)" \f "Place" }.

More facts and events for Seth Sears Raymond:

Residence: 1860 Columbus Township{ XE "USA, Pennsylvania, Warren,

¹⁸⁶ Ancestry.com, Pennsylvania, Death Certificates, 1906-1963 (Provo, UT, USA, Ancestry.com Operations, Inc., 2014), Ancestry.com, Pennsylvania Historic and Museum Commission; Pennsylvania, USA; Pennsylvania, Death Certificates, 1906-1965; Certificate Number Range: 080121-083340. Record for Louisa Page. <http://search.ancestry.com/cgi-bin/sse.dll?db=5164&h=2362084&indiv=try>.

Columbus Township:(41.9408° N, 79.582° W):Raymond,
Seth Sears (1798–1873)" \f "Place" }

Seth Sears married **Caroline Eagles**{ XE "Eagles:Caroline (-1851)" \f "Name" \b \i }. They had eleven children: Francis (1819–), Polly (1820–1822), Elizabeth (1822–1894), Renselear (1825–1910), Fidelia (1827–), V (1829–), Caroline (1832–1923), Harriet (1834–1916), Seth (1836–1856), Sears (1836–1918) and Sarah (1840–1916).

from Columbus, PA. She was the daughter of Francis Eagles{ XE "Eagles:Francis (-1817)" \f "Name" \i } and Mary Polly Low{ XE "Low:Mary \"Polly\" (-1871)" \f "Name" \i }.

She was buried in Curtis Cemetery, Columbus,{ XE "USA, Pennsylvania, Warren, Columbus, Curtis Cemetery: :Eagles, Caroline (-1851)" \f "Place" } in March 1851. Caroline died in Columbus Township{ XE "USA, Pennsylvania, Warren, Columbus Township:(41.9408° N, 79.582° W):Eagles, Caroline (-1851)" \f "Place" } on 2nd March 1851.

Bobby J Barnes: Shows her name as ENGLES

Seth Sears married **Diantha Arnold**{ XE "Arnold:Diantha (-1860)" \f "Name" \b \i }. They had no known children.

Diantha died on 18th April 1860. She was buried. David Curtis Cemetery.

- f V. **Matilda Raymond**{ XE "Raymond:Matilda (1800–)" \f "Name" \b } was born in perh, New York,{ XE "USA, New York, perh: :Raymond, Matilda (1800–)" \f "Place" } in 1800.
- m VI. **Lorenzo Raymond**{ XE "Raymond:Lorenzo (1802–)" \f "Name" \b } was born in perh{ XE "USA, New York, perh: :Raymond, Lorenzo (1802–)" \f "Place" } in 1802.

Seth Sears{ TC "Seth Sears" \I 3 \f C}

96. **Seth⁴ Sears Jr**{ XE "Sears:Seth Jr (1769–1819)" \f "Name" \b } (*Seth³, James²*) was born on Friday, 11th August 1769, in perh, Southeast, Putnam, New York, USA{ XE "USA, New York, Putnam, Southeast, perh: :Sears, Seth Jr (1769–1819)" \f "Place" }. He was the son of Seth Sears{ XE "Sears:Seth (1736–1809)" \f "Name" \i } (50) and Sarah Sears{ XE "Sears:Sarah (1734–)" \f "Name" \i } (51).

Seth died in Milltown{ XE "USA, New York, Putnam, Milltown: :Sears, Seth Jr (1769–1819)" \f "Place" } on 1st May 1819, at the age of 49. He was buried in Milltown Cemetery, Southeast{ XE "USA, New York, Putnam, Southeast, Milltown Cemetery: :Sears, Seth Jr (1769–1819)" \f "Place" }.

!Ruth G Pickard

S P May No 748 p 174

<https://www.wikitree.com/wiki/Sears-4781>

Marriages with Eunice Paddock and Ruhamah Andrews (Page 123) are known.

Family of Seth Sears and Eunice Paddock{ TC "Seth Sears and Eunice Paddock" \I 4 \f C}

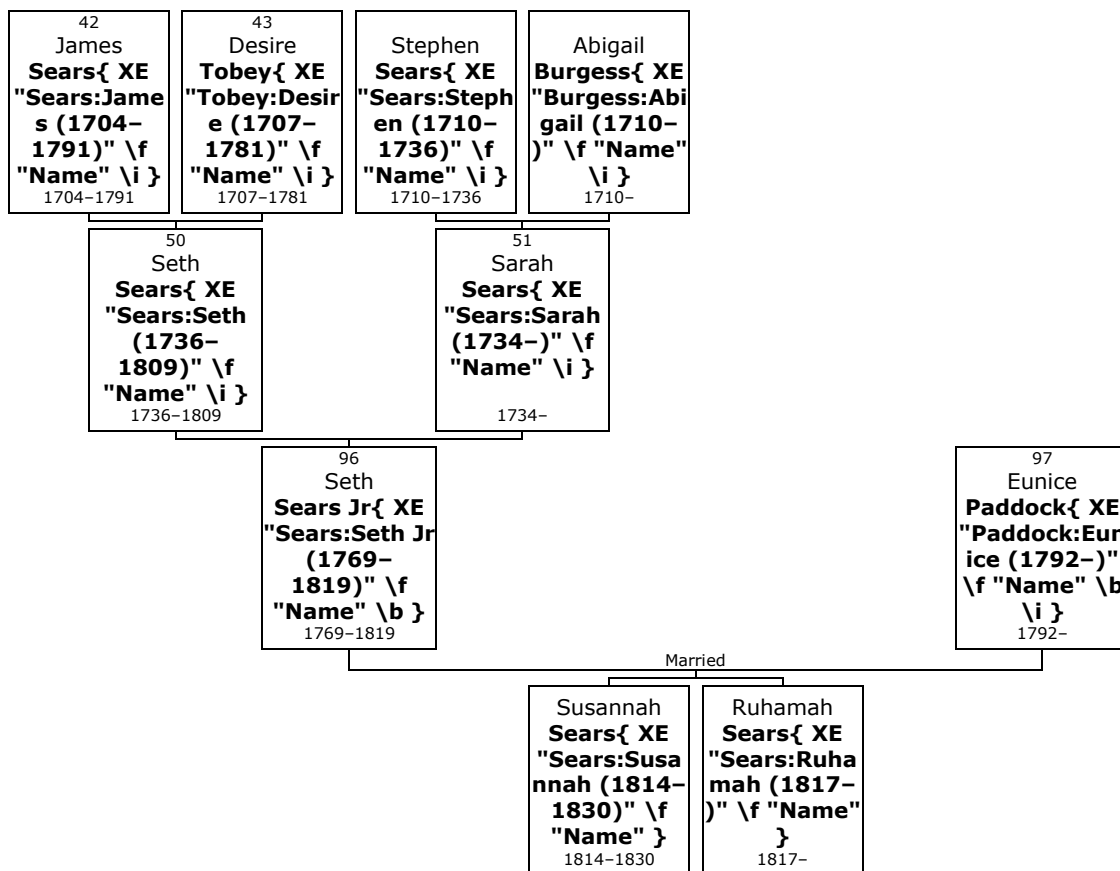

Here are the details about **Seth Sears Jr's** XE "Sears:Seth Jr (1769-1819)" \f "Name" \b } first marriage, with Eunice Paddock. You can read more about Seth on page 121.

97. Seth Sears Jr married **Eunice Paddock**{ XE "Paddock:Eunice (1792-)" \f "Name" \b \i }. They had two daughters: Susannah (1814-1830) and Ruhamah (1817-).

Eunice was born in perh{ XE "USA, New York, Putnam, Southeast, perh: :Paddock, Eunice (1792-)" \f "Place" } in 1792.

!S.P. May p.274 She was a cousin of Joseph Crane Sears, through his mother; she had two daughters by her first husband, viz.: "Blind Fanny J Crosby," the hymn writer, and Mrs Morris, who was living in Bridgeport, CT, in 1885, ae. 86, to whom I am indebted for data relative to this and connected families.

Daughters of Seth Sears Jr and Eunice Paddock:

- f I. **Susannah⁵ Sears**{ XE "Sears:Susannah (1814-1830)" \f "Name" \b } was born in Southeast{ XE "USA, New York, Putnam, Southeast:(41.4054° N, 73.6001° W):Sears, Susannah (1814-1830)" \f "Place" } in 1814. She died in Southeast{ XE "USA, New York, Putnam, Southeast:(41.4054° N, 73.6001° W):Sears, Susannah (1814-1830)" \f "Place" } on 26th December 1830, at the age of 16. Susannah was buried in Southeast{ XE "USA, New York, Putnam, Southeast:(41.4054° N, 73.6001° W):Sears, Susannah (1814-1830)" \f "Place" }.
- f II. **Ruhamah Sears**{ XE "Sears:Ruhamah (1817-)" \f "Name" \b } was born in Southeast{ XE "USA, New York, Putnam, Southeast:(41.4054° N, 73.6001° W):Sears, Ruhamah (1817-)" \f "Place" } on 14th August 1817.

Family of Seth Sears and Ruhamah Andrews{ TC "Seth Sears and Ruhamah Andrews" \I 4 \f C}

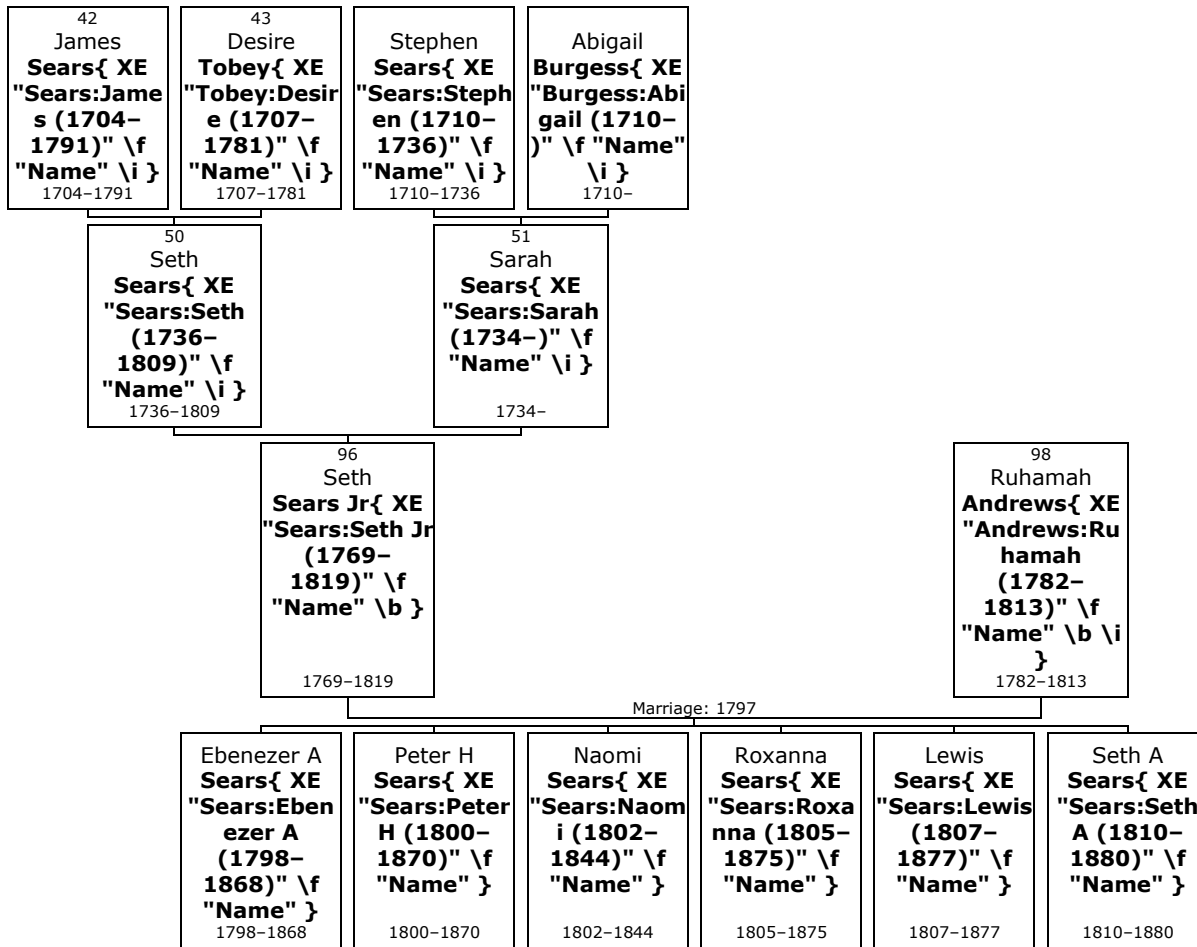

Here are the details about **Seth Sears Jr's** { XE "Sears:Seth Jr (1769-1819)" \f "Name" \b } second marriage, with Ruhamah Andrews. You can read more about Seth on page 121.

98. Seth Sears Jr married **Ruhamah Andrews**{ XE "Andrews:Ruhamah (1782-1813)" \f "Name" \b \i } on Wednesday, 23rd August 1797, in prob, Greenfield, Fairfield, Connecticut{ XE "USA, Connecticut, Fairfield, Greenfield, prob: :Sears, Seth Jr (1769-1819)" \f "Place" }. They had six children: Ebenezer (1798-1868), Peter (1800-1870), Naomi (1802-1844), Roxanna (1805-1875), Lewis (1807-1877) and Seth (1810-1880).

Ruhamah was born in 1782. She reached 31 years of age and died on 9th December 1813. Ruhamah was buried in Milltown Cemetery, Southeast, Putnam, New York{ XE "USA, New York, Putnam, Southeast, Milltown Cemetery: :Andrews, Ruhamah (1782-1813)" \f "Place" }.

Children of Seth Sears Jr and Ruhamah Andrews:

- m I. **Ebenezer A⁵ Sears**{ XE "Sears:Ebenezer A (1798-1868)" \f "Name" \b } was born in Southeast, Putnam, New York,{ XE "USA, New York, Putnam, Southeast:(41.4054° N, 73.6001° W):Sears, Ebenezer A (1798-1868)" \f "Place" } on 28th September 1798. He died in 1868 at the age of 69.
- m II. **Peter H Sears**{ XE "Sears:Peter H (1800-1870)" \f "Name" \b } was born in Southeast{ XE "USA, New York, Putnam, Southeast:(41.4054° N, 73.6001° W):Sears, Peter H (1800-1870)" \f "Place" } on 26th August 1800. He died in 1870 at the age of 69.
- f III. **Naomi Sears**{ XE "Sears:Naomi (1802-1844)" \f "Name" \b } was born in Southeast{ XE "USA, New York, Putnam, Southeast:(41.4054° N, 73.6001° W):Sears, Naomi (1802-1844)" \f "Place" } on 11th October 1802. She died in 1844 at the age of 41.
Naomi married **Horace Williams**{ XE "Williams:Horace (1799-1856)" \f "Name" \b \i }. They had one son: Lewis (1833-1904).

Horace was born in 1799. He was the son of Joseph Williams Jr{ XE "Williams:Joseph Jr (1768-1856)" \f "Name" \i } and Hannah Crane{ XE "Crane:Hannah (1767-1822)" \f "Name" \i }.

Horace reached 57 years of age and died in 1856.

f IV. **Roxanna Sears**{ XE "Sears:Roxanna (1805-1875)" \f "Name" \b } was born in Southeast{ XE "USA, New York, Putnam, Southeast:(41.4054° N, 73.6001° W):Sears, Roxanna (1805-1875)" \f "Place" } on 1st April 1805. She died in 1875 at the age of 69.

m V. **Lewis Sears**{ XE "Sears:Lewis (1807-1877)" \f "Name" \b } was born in Southeast{ XE "USA, New York, Putnam, Southeast:(41.4054° N, 73.6001° W):Sears, Lewis (1807-1877)" \f "Place" } on 29th July 1807. He died in 1877 at the age of 69.

m VI. **Seth A Sears**{ XE "Sears:Seth A (1810-1880)" \f "Name" \b } was born in Southeast{ XE "USA, New York, Putnam, Southeast:(41.4054° N, 73.6001° W):Sears, Seth A (1810-1880)" \f "Place" } on 16th November 1810. He died in Norwalk, Fairfield, Connecticut,{ XE "USA, Connecticut, Fairfield, Norwalk:(41.1176° N, 73.4079° W):Sears, Seth A (1810-1880)" \f "Place" } in 1880 at the age of 69.

Seth A Sears married **Polly --Sears**{ XE "--Sears:Polly (1814-)" \f "Name" \b \i }. They had no known children.

Polly was born in perh, Southeast, Putnam, New York,{ XE "USA, New York, Putnam, Southeast, perh: :--Sears, Polly (1814-)" \f "Place" } in 1814.

Family of Eleazar Sears and Betsy Marvin{ TC "Eleazar Sears and Betsy Marvin" \I 3 \f C}

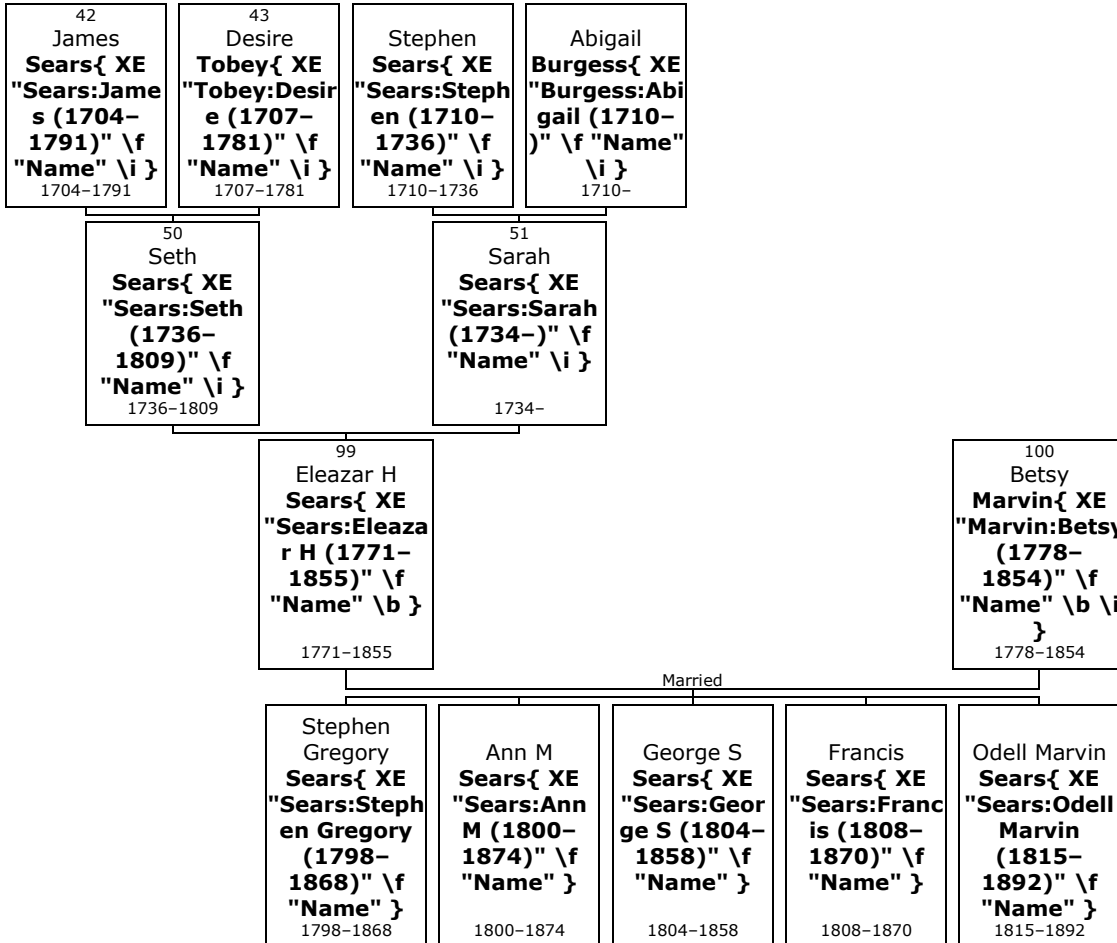

99. **Eleazar H⁴ Sears**{ XE "Sears:Eleazar H (1771-1855)" \f "Name" \b } (*Seth³, James²*) was born in 1771 in Danbury or, Southeast, Putnam, New York, USA{ XE "USA, New York, Putnam, Southeast, Danbury or:

:Sears, Eleazar H (1771–1855)" \f "Place" }.^[187] He was the son of Seth Sears{ XE "Sears:Seth (1736–1809)" \f "Name" \i } (50) and Sarah Sears{ XE "Sears:Sarah (1734–)" \f "Name" \i } (51).

Eleazar H died in De Ruyter, Madison,{ XE "USA, New York, Madison, De Ruyter:(42.7585° N, 75.8868° W):Sears, Eleazar H (1771–1855)" \f "Place" } in 1855 at the age of 84.^[187] He was buried in De Ruyter{ XE "USA, New York, Madison, De Ruyter:(42.7585° N, 75.8868° W):Sears, Eleazar H (1771–1855)" \f "Place" }.^[187]

!Ruth G Pickard- Served with his brother Seth as an administrator of their father's will (1809)
!

!CHILDREN: William H Tuttle, NAMES AND SKETCHES OF THE PIONEER SETTLERS OF MADISON COUNTY NY; 1821-1868; Interlaken, Heart of the Lakes Publishing, 1985; p 221; CT State Library; settled in DeRuyter 1805. Sons Stephen G, George S, Francis

<https://www.wikitree.com/wiki/Sears-4782>

<https://www.findagrave.com/memorial/43449649>- tombstone is spelled Eleazer

- 100.** Eleazar H married **Betsy Marvin**{ XE "Marvin:Betsy (1778–1854)" \f "Name" \b \i } in Southeast, Putnam{ XE "USA, New York, Putnam, Southeast:(41.4054° N, 73.6001° W):Sears, Eleazar H (1771–1855)" \f "Place" }.^[187] They had five children: Stephen (1798–1868), Ann (1800–1874), George (1804–1858), Francis (1808–1870) and Odell (1815–1892).

Betsy was born in perh, Southeast,{ XE "USA, New York, Putnam, Southeast, perh: :Marvin, Betsy (1778–1854)" \f "Place" } in 1778.^[187] She reached 76 years of age and died in De Ruyter, Madison,{ XE "USA, New York, Madison, De Ruyter:(42.7585° N, 75.8868° W):Marvin, Betsy (1778–1854)" \f "Place" } in 1854.^[187] Betsy was buried in De Ruyter{ XE "USA, New York, Madison, De Ruyter:(42.7585° N, 75.8868° W):Marvin, Betsy (1778–1854)" \f "Place" }.^[187]

Children of Eleazar H Sears and Betsy Marvin:

- m I. **Stephen Gregory⁵ Sears**{ XE "Sears:Stephen Gregory (1798–1868)" \f "Name" \b } was born in Southeast{ XE "USA, New York, Putnam, Southeast:(41.4054° N, 73.6001° W):Sears, Stephen Gregory (1798–1868)" \f "Place" } in 1798.^[187, 188, 189, 190, 191, 192, 193, 194, 195–196] He died in De Ruyter{ XE "USA, New York, Madison, De Ruyter:(42.7585° N, 75.8868° W):Sears, Stephen Gregory (1798–1868)" \f "Place" } on 4th August 1868, at the age of 70.^[187, 188, 193] Stephen Gregory was buried in De Ruyter{ XE "USA, New York, Madison, De Ruyter:(42.7585° N, 75.8868° W):Sears, Stephen Gregory (1798–1868)" \f "Place" }.^[187, 193]

More facts and events for Stephen Gregory Sears:

Residence: 1840 De Ruyter{ XE "USA, New York, Madison, De Ruyter:(42.7585° N, 75.8868° W):Sears,

¹⁸⁷ Ancestry.com, U.S., Find A Grave Index, 1600s-Current (Provo, UT, USA, Ancestry.com Operations, Inc., 2012), Ancestry.com.
¹⁸⁸ Edmund West, comp., Family Data Collection - Individual Records (Provo, UT, USA, Ancestry.com Operations Inc, 2000), Ancestry.com, Birth year: 1798; Birth city: Southeast; Birth state: NY.
¹⁸⁹ Ancestry.com, New York, State Census, 1855 (Provo, UT, USA, Ancestry.com Operations, Inc., 2013), Ancestry.com.
¹⁹⁰ Ancestry.com, New York, State Census, 1865 (Provo, UT, USA, Ancestry.com Operations, Inc., 2014), Ancestry.com.
¹⁹¹ Ancestry.com, 1850 United States Federal Census (Provo, UT, USA, Ancestry.com Operations, Inc., 2009), Ancestry.com, Year: 1850; Census Place: De Ruyter, Madison, New York; Roll: M432_527; Page: 292A; Image: 44.
¹⁹² Ancestry.com, 1860 United States Federal Census (Provo, UT, USA, Ancestry.com Operations, Inc., 2009), Ancestry.com, Year: 1860; Census Place: De Ruyter, Madison, New York; Roll: M653_780; Page: 266; Image: 271; Family History Library Film: 803780.
¹⁹³ Ancestry.com, Web: New York, Find A Grave Index, 1660-2012 (Provo, UT, USA, Ancestry.com Operations, Inc., 2012), Ancestry.com.
¹⁹⁴ Ancestry.com, 1840 United States Federal Census (Provo, UT, USA, Ancestry.com Operations, Inc., 2010), Ancestry.com, Year: 1840; Census Place: De Ruyter, Madison, New York; Roll: 295; Page: 142; Image: 291; Family History Library Film: 0017192.
¹⁹⁵ Ancestry.com, New York, Compiled Census and Census Substitutes Index, 1790-1890 (Provo, UT, USA, Ancestry.com Operations Inc, 1999), Ancestry.com.
¹⁹⁶ Ancestry.com, U.S., Appointments of U. S. Postmasters, 1832-1971 (Provo, UT, USA, Ancestry.com Operations, Inc., 2010), Ancestry.com.

	Stephen Gregory (1798–1868)" \f "Place" } ^[194]
Residence: 27 th April 1844	De Ruyter{ XE "USA, New York, Madison, De Ruyter:(42.7585° N, 75.8868° W):Sears, Stephen Gregory (1798–1868)" \f "Place" } ^[196]
Residence: 1850	De Ruyter{ XE "USA, New York, Madison, De Ruyter:(42.7585° N, 75.8868° W):Sears, Stephen Gregory (1798–1868)" \f "Place" } ^[191]
Residence: 1855	De Ruyter{ XE "USA, New York, Madison, De Ruyter:(42.7585° N, 75.8868° W):Sears, Stephen Gregory (1798–1868)" \f "Place" } ^[189] Relation to Head of House: Head
Residence: 1860	De Ruyter{ XE "USA, New York, Madison, De Ruyter:(42.7585° N, 75.8868° W):Sears, Stephen Gregory (1798–1868)" \f "Place" } ^[192, 195]
Residence: 1865	De Ruyter{ XE "USA, New York, Madison, De Ruyter:(42.7585° N, 75.8868° W):Sears, Stephen Gregory (1798–1868)" \f "Place" } ^[190] Relation to Head of House: Head

Stephen Gregory married **Susan Ann Mitchell**{ XE "Mitchell:Susan Ann (1801–1890)" \f "Name" \b \i }.^[189, 190] They had four children: Mary (1832–1889), Cornelia (ca.1834–), William (ca.1837–) and George (ca.1840–).

Susan Ann was born in Connecticut{ XE "USA, Connecticut:(41.5735° N, 72.7383° W):Mitchell, Susan Ann (1801–1890)" \f "Place" } in 1801.^[189, 190] She reached 89 years of age and died in De Ruyter{ XE "USA, New York, Madison, De Ruyter:(42.7585° N, 75.8868° W):Mitchell, Susan Ann (1801–1890)" \f "Place" } on 8th October 1890.

- f II. **Ann M Sears**{ XE "Sears:Ann M (1800–1874)" \f "Name" \b } was born in Southeast{ XE "USA, New York, Putnam, Southeast:(41.4054° N, 73.6001° W):Sears, Ann M (1800–1874)" \f "Place" } in 1800. She died in Cazenovia, Madison,{ XE "USA, New York, Madison, Cazenovia:(42.9301° N, 75.8527° W):Sears, Ann M (1800–1874)" \f "Place" } in 1874 at the age of 74.
- m III. **George S Sears**{ XE "Sears:George S (1804–1858)" \f "Name" \b } was born in Southeast{ XE "USA, New York, Putnam, Southeast:(41.4054° N, 73.6001° W):Sears, George S (1804–1858)" \f "Place" } in 1804. He died in De Ruyter, Madison,{ XE "USA, New York, Madison, De Ruyter:(42.7585° N, 75.8868° W):Sears, George S (1804–1858)" \f "Place" } in 1858 at the age of 54.
- m IV. **Francis Sears**{ XE "Sears:Francis (1808–1870)" \f "Name" \b } was born in perh, Southeast,{ XE "USA, New York, Putnam, Southeast, perh: :Sears, Francis (1808–1870)" \f "Place" } in 1808.^[197] He died in Homer, Cortland,{ XE "USA, New York, Cortland, Homer:(42.637° N, 76.1788° W):Sears, Francis (1808–1870)" \f "Place" } in 1870 at the age of 62.

Francis Sears married **Mary Nye**{ XE "Nye:Mary (1809–1854)" \f "Name" \b \i }.^[197] They had five daughters: Celestia (1831–), Annie (1834–1890), Mary (1837–), Sarah (1839–) and Katherine (1843–1872).

Mary was born in De Ruyter, Madison,{ XE "USA, New York, Madison, De Ruyter:(42.7585° N, 75.8868° W):Nye, Mary (1809–1854)" \f "Place" } on Saturday, 2nd

¹⁹⁷ Ancestry.com, U.S., Sons of the American Revolution Membership Applications, 1889-1970 (Provo, UT, USA, Ancestry.com Operations, Inc., 2011), Ancestry.com, Volume: 19.

September 1809. She was the daughter of James Nye{ XE "Nye:James" \f "Name" \i } and Thankful Crocker{ XE "Crocker:Thankful" \f "Name" \i }.

Mary reached 45 years of age and died on 25th December 1854.

<http://freepages.genealogy.rootsweb.ancestry.com/~wingfamilyofamerica/p907.htm#i2012141>

m

V. **Odell Marvin Sears**{ XE "Sears:Odell Marvin (1815–1892)" \f "Name" \b } was born in De Ruyter, Madison,{ XE "USA, New York, Madison, De Ruyter:(42.7585° N, 75.8868° W):Sears, Odell Marvin (1815–1892)" \f "Place" } on 4th April 1815.^[187, 189, 198] He died in Cortland{ XE "USA, New York, Cortland, Cortland:(42.6012° N, 76.1805° W):Sears, Odell Marvin (1815–1892)" \f "Place" } on 7th November 1892, at the age of 77.^[187] Odell Marvin was buried in Cortland{ XE "USA, New York, Cortland, Cortland:(42.6012° N, 76.1805° W):Sears, Odell Marvin (1815–1892)" \f "Place" }.^[187]



Odell

More facts and events for Odell Marvin Sears:

Residence: 1855 Truxton{ XE "USA, New York, Cortland, Truxton:(42.7119° N, 76.0289° W):Sears, Odell Marvin (1815–1892)" \f "Place" }.^[189]
Relation to Head of House: Head

Residence: 1880 Cortlandville{ XE "USA, New York, Cortland, Cortlandville:(42.5923° N, 76.1569° W):Sears, Odell Marvin (1815–1892)" \f "Place" }.^[198]
Marital status: Married; Relation to Head of House: Self

Odell Marvin Sears married **Mary Gidley**{ XE "Gidley:Mary (1825–1900)" \f "Name" \b \i } in 1846 in De Ruyter, Madison{ XE "USA, New York, Madison, De Ruyter:(42.7585° N, 75.8868° W):Sears, Odell Marvin (1815–1892)" \f "Place" }.^[187, 189, 198] They had two sons: George (1848–1907) and Frank (1860–1921).

Mary was born in Devon, England,{ XE "England, Devon:(50.8131° N, 3.7526° W):Gidley, Mary (1825–1900)" \f "Place" } in 1825.^[187, 189, 198] She reached 75 years of age and died on 20th June 1900.^[187]

Mary was buried in Cortland{ XE "USA, New York, Cortland, Cortland:(42.6012° N, 76.1805° W):Gidley, Mary (1825–1900)" \f "Place" }.^[187]

¹⁹⁸ Ancestry.com and The Church of Jesus Christ of Latter-day Saints, 1880 United States Federal Census (Provo, UT, USA, Ancestry.com Operations Inc, 2010), Ancestry.com, Year: 1880; Census Place: Cortlandville, Cortland, New York; Roll: 822; Family History Film: 1254822; Page: 32C; Enumeration District: 118; Image: 0066.

Family of Thankful Sears and William Smith{ TC "Thankful Sears and William Smith" \I 3 \f C}

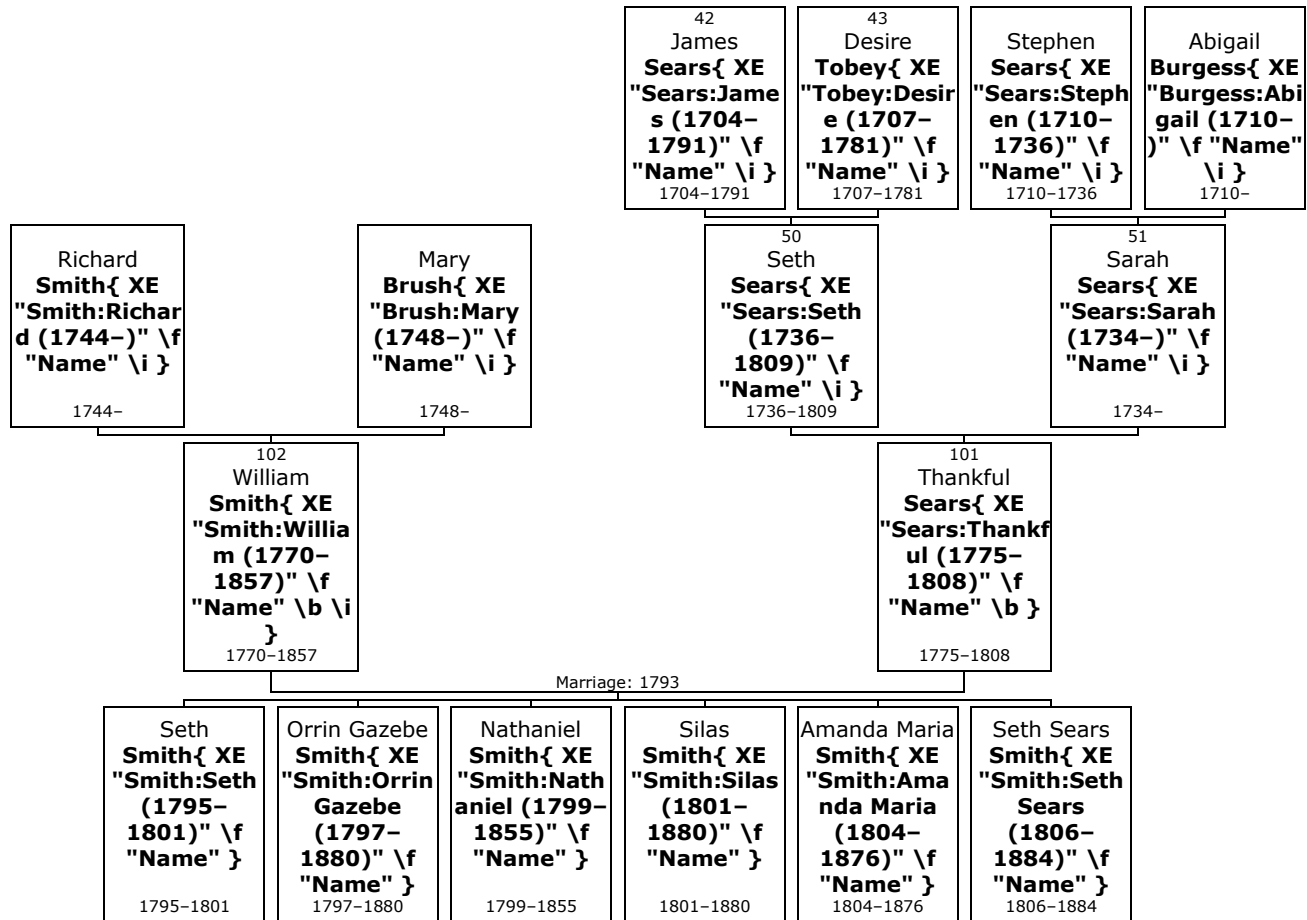

- 101.** **Thankful⁴ Sears**{ XE "Sears:Thankful (1775-1808)" \f "Name" \b } (*Seth³, James²*) was born on Friday, 30th June 1775, in Southeast, Putnam, New York, USA{ XE "USA, New York, Putnam, Southeast:(41.4054° N, 73.6001° W):Sears, Thankful (1775-1808)" \f "Place" }. She was the daughter of Seth Sears{ XE "Sears:Seth (1736-1809)" \f "Name" \i } (50) and Sarah Sears{ XE "Sears:Sarah (1734-)" \f "Name" \i } (51).

Thankful died in Litchfield, Herkimer,{ XE "USA, New York, Herkimer, Litchfield:(42.9776° N, 75.1507° W):Sears, Thankful (1775-1808)" \f "Place" } on 28th July 1808, at the age of 33.

!Ruth G Pickard These families (Thankful's daughter) moved to Chataqua co, NY. Norman's sister, Lucy Spencer nmarried Robert Delos Rider, son of Thankful's older sister, Naomi(Sears) Rider. Thus the first cousins Robert Rider and Amanda Smith married a brother and a sister.

<https://www.wikitree.com/wiki/Sears-4783>

- 102.** At the age of 18, Thankful married **Rev William Smith**{ XE "Smith:William (1770-1857)" \f "Name" \b \i } on Friday, 27th December 1793, in Southeast, Putnam,{ XE "USA, New York, Putnam, Southeast:(41.4054° N, 73.6001° W):Sears, Thankful (1775-1808)" \f "Place" } when he was 23 years old. They had six children: Seth (1795-1801), Orrin (1797-1880), Nathaniel (1799-1855), Silas (1801-1880), Amanda (1804-1876) and Seth (1806-1884).

William was born in West Farms, Suffolk,{ XE "USA, New York, Suffolk, West Farms: :Smith, William (1770-1857)" \f "Place" } on Tuesday, 20th March 1770. He was the son of Richard Smith{ XE "Smith:Richard (1744-)" \f "Name" \i } and Mary Brush{ XE "Brush:Mary (1748-)" \f "Name" \i }.

William reached 87 years of age and died in Bedford, Coshocton, Ohio,{ XE "USA, Ohio, Coshocton, Bedford:(41.3931° N, 81.5365° W):Smith, William (1770-1857)" \f "Place" } on 29th July 1857.

!S.P. May p.175 William lived at one time at Huntington, L.I., and was a dry- goods clerk at Jamaica, and in NY City. In 1793 he rem. to Litchfield, and settled on a farm, selling out in June, 1846, and removing to Bedford, OH, with his wife and four youngest shildren, his sons Seth, Charles, and Richard being established on neighboring farms.

Children of Thankful Sears and William Smith:

- m I. **Seth⁵ Smith**{ XE "Smith:Seth (1795–1801)" \f "Name" \b } was born in perh, Southeast,{ XE "USA, New York, Putnam, Southeast, perh: :Smith, Seth (1795–1801)" \f "Place" } on 31st March 1795. He died on 28th October 1801, at the age of 6.
- m II. **Orrin Gazebe Smith**{ XE "Smith:Orrin Gazebe (1797–1880)" \f "Name" \b } was born in perh{ XE "USA, New York, Putnam, Southeast, perh: :Smith, Orrin Gazebe (1797–1880)" \f "Place" } on 6th May 1797. He died on 1st July 1880, at the age of 83.
- Orrin Gazebe married **Mary Crawford**{ XE "Crawford:Mary (1801–)" \f "Name" \b \i }. They had no known children.
- Mary was born in Arkwright, Chautauqua,{ XE "USA, New York, Chautauqua, Arkwright:(42.4069° N, 79.2367° W):Crawford, Mary (1801–)" \f "Place" } in 1801.
- m III. **Nathaniel Smith**{ XE "Smith:Nathaniel (1799–1855)" \f "Name" \b } was born in perh{ XE "USA, New York, Putnam, Southeast, perh: :Smith, Nathaniel (1799–1855)" \f "Place" } on 3rd July 1799. He died on 11th June 1855, at the age of 55.
- At the age of 23, Nathaniel Smith married **Polly Gordon**{ XE "Gordon:Polly (1796–1855)" \f "Name" \b \i } on Thursday, 20th February 1823, when she was 26 years old. They had two children: William (1839–) and Furilla.
- Polly was born on Saturday, 7th May 1796. She reached 59 years of age and died on 11th June 1855.
- !S.P. May Had 4 sons and 3 daus
- m IV. **Silas Smith**{ XE "Smith:Silas (1801–1880)" \f "Name" \b } was born in perh{ XE "USA, New York, Putnam, Southeast, perh: :Smith, Silas (1801–1880)" \f "Place" } on 14th October 1801. He died in Medina, Orleans,{ XE "USA, New York, Orleans, Medina:(43.2201° N, 78.387° W):Smith, Silas (1801–1880)" \f "Place" } on 22nd March 1880, at the age of 78.
- Silas Smith married **Minerva McCracken**{ XE "McCracken:Minerva (1804–1830)" \f "Name" \b \i } on Friday, 15th April 1825. They had one daughter: Frances (1828–).
- Minerva was born in perh, Medina,{ XE "USA, New York, Orleans, Medina, perh: :McCracken, Minerva (1804–1830)" \f "Place" } in 1804. She reached 26 years of age and died on 10th December 1830.
- At the age of 29, Silas Smith married **Mary Ann Bristol**{ XE "Bristol:Mary Ann (1808–)" \f "Name" \b \i } on Thursday, 15th September 1831, when she was 23 years old. They had three sons: Charles (1833–), William (1836–) and George (1844–).
- Mary Ann was born in Cato, Cayuga,{ XE "USA, New York, Cayuga, Cato:(43.1681° N, 76.573° W):Bristol, Mary Ann (1808–)" \f "Place" } on Wednesday, 18th May 1808.
- f V. **Amanda Maria Smith**{ XE "Smith:Amanda Maria (1804–1876)" \f "Name" \b } was born in perh{ XE "USA, New York, Putnam, Southeast, perh: :Smith, Amanda Maria (1804–1876)" \f "Place" } on 12th January 1804.^[199, 200] She died in April 1876 at the age of 72.
- At the age of 19, Amanda Maria Smith married **Norman Spencer**{ XE "Spencer:Norman (1800–1872)" \f "Name" \b \i } on Tuesday, 22nd April 1823, in Litchfield, Herkimer,{ XE "USA, New York, Herkimer, Litchfield:(42.9776° N, 75.1507° W):Smith, Amanda Maria (1804–1876)" \f "Place" } when he was 22 years old.^[199, 200] They had ten children: Ery(Eri) (1823–1906), infant (1825–1825), Henry (1826–1887), Thankful (1829–), Julia (1832–), Calvin (1834–), Sarah (1837–1918), Jane (1840–), Charles (1842–1917) and James (1844–1921).
- Norman was born in perh, Fowlerville, Livingston, Michigan,{ XE "USA, Michigan, Livingston, Fowlerville, perh: :Spencer, Norman (1800–1872)" \f "Place" } on Sunday,

¹⁹⁹ Ancestry.com, Michigan, Death Records, 1867-1950 (Provo, UT, USA, Ancestry.com Operations, Inc., 2015), Ancestry.com, Michigan Department of Community Health, Division for Vital Records and Health Statistics; Lansing, Michigan. Record for Charles E Spencer. <http://search.ancestry.com/cgi-bin/sse.dll?db=60872&h=3528306&indiv=try>.

²⁰⁰ Ancestry.com, Michigan, Death Records, 1897-1920 (Provo, UT, USA, Ancestry.com Operations, Inc., 2010), Ancestry.com, The Library of Michigan; Michigan Death Records Project; Rolls: 1-302; Archive Barcode/Item Number: 30000008534053; Roll Number: 242; Certificate Number: 5. Record for Charles E Spencer. <http://search.ancestry.com/cgi-bin/sse.dll?db=1561&h=1780228&indiv=try>.

14th September 1800.^[199] He was the son of Gideon Spencer Jr{ XE "Spencer:Gideon Jr (1774-)" \f "Name" \i } and Susan S Warner{ XE "Warner:Susan S (1778-)" \f "Name" \i }.

Norman reached 72 years of age and died in Fowlerville{ XE "USA, Michigan, Livingston, Fowlerville:(42.6606° N, 84.073° W):Spencer, Norman (1800-1872)" \f "Place" } on 5th October 1872.

m VI. **Seth Sears Smith**{ XE "Smith:Seth Sears (1806-1884)" \f "Name" \b } was born in perh{ XE "USA, New York, Putnam, Southeast, perh: :Smith, Seth Sears (1806-1884)" \f "Place" } on 10th April 1806. He died on 5th July 1884, at the age of 78.

Seth Sears Smith married **Lydia Ann Morgan**{ XE "Morgan:Lydia Ann" \f "Name" \b \i } in September 1826. They had four children: Amanda (1827-), Amelia (1829-), Albert (1831-) and William (1836-).

Seth Sears married **Mary Richards**{ XE "Richards:Mary (-1853)" \f "Name" \b \i } on Thursday, 14th September 1848. They had two daughters: Fannie (1849-) and Addie (1852-1853).

Mary died on 6th May 1853.

Family of Eli Sears and Hanna Bull{ TC "Eli Sears and Hanna Bull" \I 3 \f C}

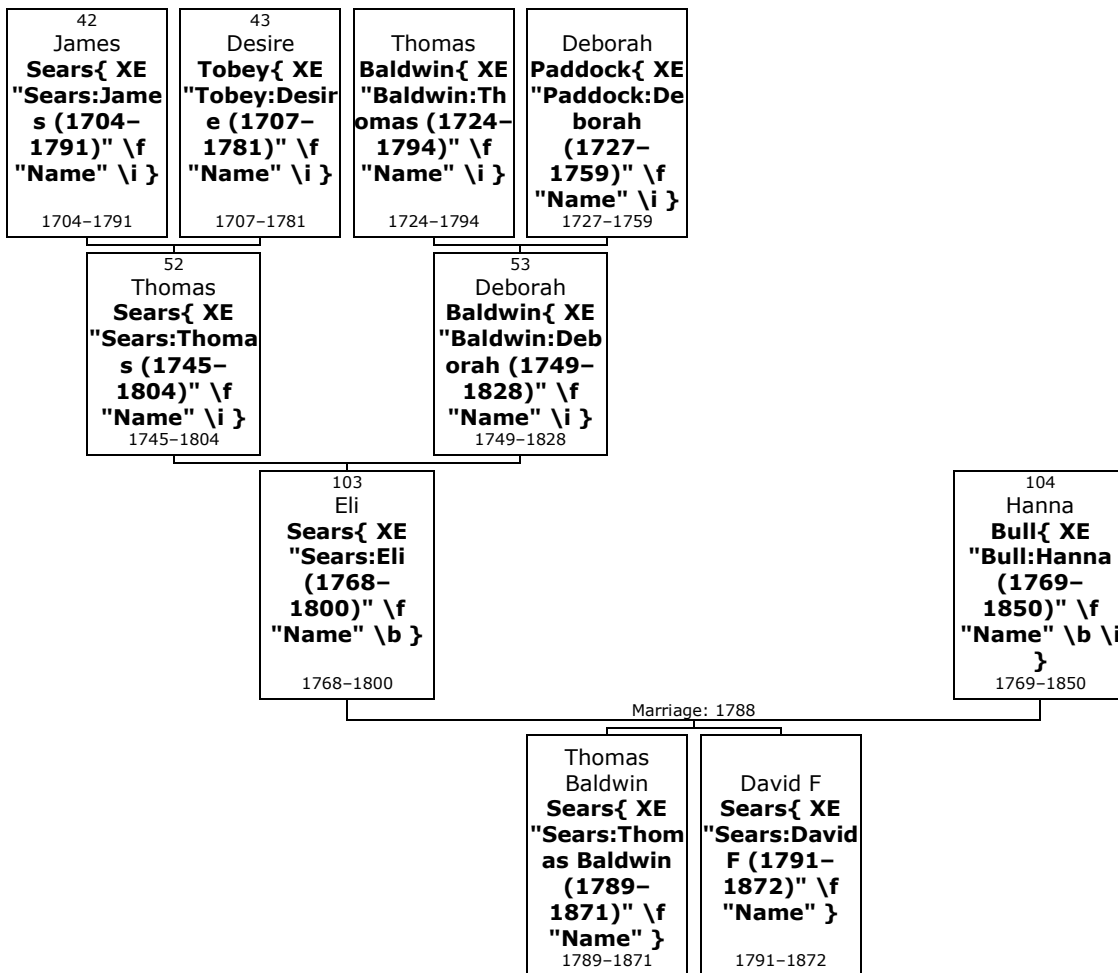

103. Eli⁴ Sears{ XE "Sears:Eli (1768-1800)" \f "Name" \b } (*Capt Thomas³, James²*) was born on Sunday, 16th October 1768, in Southeast, Putnam, New York, USA{ XE "USA, New York, Putnam, Southeast:(41.4054° N, 73.6001° W):Sears, Eli (1768-1800)" \f "Place" }.^[201, 202-203] He was the son of Thomas Sears{ XE

²⁰¹ Ancestry.com, U.S., Sons of the American Revolution Membership Applications, 1889-1970 (Provo, UT, USA, Ancestry.com Operations, Inc., 2011), Ancestry.com, Volume: 156. [Source citation includes one media item]

"Sears:Thomas (1745–1804)" \f "Name" \i } (52) and Deborah Baldwin{ XE "Baldwin:Deborah (1749–1828)" \f "Name" \i } (53).

Eli died in Carmel{ XE "USA, New York, Putnam, Carmel:(41.4301° N, 73.6801° W):Sears, Eli (1768–1800)" \f "Place" } on 16th March 1800, at the age of 31.^[201, 202]

S P May p 178 No 766 b., d., m., children

<https://www.wikitree.com/wiki/Sears-2209>

- 104.** At the age of 19, Eli married **Hanna Bull**{ XE "Bull:Hanna (1769–1850)" \f "Name" \b \i } on Sunday, 24th February 1788, in Carmel{ XE "USA, New York, Putnam, Carmel:(41.4301° N, 73.6801° W):Sears, Eli (1768–1800)" \f "Place" } when she was 18 years old.^[201–204] They had two sons: Thomas (1789–1871) and David (1791–1872).

Hanna was born in Carmel{ XE "USA, New York, Putnam, Carmel:(41.4301° N, 73.6801° W):Bull, Hanna (1769–1850)" \f "Place" } on Friday, 17th March 1769.^[201, 202, 204] She reached 80 years of age and died in Searsburg, Schuyler,{ XE "USA, New York, Schuyler, Searsburg: :Bull, Hanna (1769–1850)" \f "Place" } on 4th February 1850.^[201, 202, 204] Hanna was buried in Trumansburg, Tompkins County{ XE "USA, New York, Tompkins County, Trumansburg:(42.5423° N, 76.6661° W):Bull, Hanna (1769–1850)" \f "Place" }.^[204]

Dori Atlantis- 2 Feb 2019

I am descended from Sacket Sears (1827-1899)

I have a question about Eli Sears' wife- Hannah Bull 1769-1850. Do you know who her parents are? Pamela Sears Cooper FamilySearch has her parents as Crispin Bull (1741-1810) and Mary Carpenter (1740-1833)

Sons of Eli Sears and Hanna Bull:

- m I. **Thomas Baldwin⁵ Sears**{ XE "Sears:Thomas Baldwin (1789–1871)" \f "Name" \b } was born in Southeast{ XE "USA, New York, Putnam, Southeast:(41.4054° N, 73.6001° W):Sears, Thomas Baldwin (1789–1871)" \f "Place" } on 2nd March 1789.^[201, 205, 206, 207, 208–209] He served in the military in New York{ XE "USA, New York:(42.7531° N, 74.2224° W):Sears, Thomas Baldwin (1789–1871)" \f "Place" }.^[208]



Thomas

Thomas Baldwin died in Searsburg, Hector,{ XE "USA, New York, Schuyler, Hector, Searsburg: :Sears, Thomas Baldwin (1789–1871)" \f "Place" } on 28th June 1871, at the age of 82.^[201, 202, 204, 207] He was buried in Trumansburg, Tompkins{ XE "USA, New York, Tompkins, Trumansburg:(42.5423° N, 76.6661° W):Sears, Thomas Baldwin (1789–1871)" \f "Place" }.^[204] His estate was probated on 23rd September 1871, in Schuyler{ XE "USA, New York, Schuyler:(42.3898° N, 76.877° W):Sears, Thomas Baldwin (1789–1871)" \f "Place" }.^[207]

More facts and events for Thomas Baldwin Sears:

Residence: 1855 Hector, Schuyler{ XE "USA, New York, Schuyler,

²⁰² Ancestry.com, U.S., Sons of the American Revolution Membership Applications, 1889-1970 (Provo, UT, USA, Ancestry.com Operations, Inc., 2011), Ancestry.com, Volume: 143. [Source citation includes one media item]

²⁰³ Ancestry.com, North America, Family Histories, 1500-2000 (Provo, UT, USA, Ancestry.com Operations, Inc., 2016), Ancestry.com, Book Title: Lineage Book of the Charter Members of the DAR Vol 017. [Source citation includes one media item]

²⁰⁴ Ancestry.com, U.S., Find A Grave Index, 1600s-Current (Provo, UT, USA, Ancestry.com Operations, Inc., 2012), Ancestry.com.

²⁰⁵ Ancestry.com, New York, State Census, 1855 (Provo, UT, USA, Ancestry.com Operations, Inc., 2013), Ancestry.com.

²⁰⁶ Ancestry.com, New York, State Census, 1865 (Provo, UT, USA, Ancestry.com Operations, Inc., 2014), Ancestry.com.

²⁰⁷ Ancestry.com, New York, Wills and Probate Records, 1659-1999 (Provo, UT, USA, Ancestry.com Operations, Inc., 2015), Ancestry.com, Probate Records, 1829-1917; Probate Index, 1855-1970; Author: New York. Surrogate's Court (Schuyler County); Probate Place: Schuyler, New York.

²⁰⁸ Ancestry.com, War of 1812 Pension Application Files Index, 1812-1815 (Provo, UT, USA, Ancestry.com Operations Inc, 2010), Ancestry.com.

²⁰⁹ Native Soil, Native Soil Manuscripts Index (Provo, UT, USA, Ancestry.com Operations Inc, 1999), Ancestry.com.

Hector:(42.5006° N, 76.8728° W):Sears, Thomas Baldwin (1789–1871)" \f "Place" }^[205]
 Relation to Head of House: Head

Residence: 1865 Hector{ XE "USA, New York, Schuyler, Hector:(42.5006° N, 76.8728° W):Sears, Thomas Baldwin (1789–1871)" \f "Place" }^[206]
 Relation to Head of House: Head

At the age of 26, Thomas Baldwin married **Maria Boardman**{ XE "Boardman: Maria (1800–1888)" \f "Name" \b \i } on Friday, 1st March 1816, in Covert, Seneca, { XE "USA, New York, Seneca, Covert:(42.5753° N, 76.6839° W):Sears, Thomas Baldwin (1789–1871)" \f "Place" } when she was 16 years old.^[201–206, 210]

They had thirteen children: Eli (1816–1872), Alfred (1818–1891), Baldwin (1820–1912), Emeline (1822–1891), Edgar (1824–1887), Malana (1825–1900), Sackett (1827–1899), Hanna (1829–1906), Lorna (1831–), Truman (1833–1907), David (1836–1900), Clermont (1838–1916) and Ossain (1843–1907). Maria was born in New Hampshire { XE "USA, New Hampshire:(43.6855° N, 71.5776° W):Boardman, Maria (1800–1888)" \f "Place" } on Wednesday, 15th January 1800.^[201, 202, 204–206] She was the daughter of Allyn Boardman { XE "Boardman: Allyn (1773–1837)" \f "Name" \i } and Phoebe Woodworth { XE "Woodworth: Phoebe (1776–1856)" \f "Name" \i }.

Maria reached 88 years of age and died in New York { XE "USA, New York:(42.7531° N, 74.2224° W):Boardman, Maria (1800–1888)" \f "Place" } on 2nd October 1888.^[201, 202, 204] She was buried in Southeast, Putnam, New York { XE "USA, New York, Putnam, Southeast:(41.4054° N, 73.6001° W):Boardman, Maria (1800–1888)" \f "Place" }.^[204]

!S.P. May p.423 now lives in Searsburg d. ae 80,1 d. 2 Oct 1858 d. 28 Jun 1871
 Ancestry shows d. 1889

<https://www.wikitree.com/wiki/Boardman-2216>

m II. **David F Sears**{ XE "Sears: David F (1791–1872)" \f "Name" \b } was born in Southeast { XE "USA, New York, Putnam, Southeast:(41.4054° N, 73.6001° W):Sears, David F (1791–1872)" \f "Place" } on 17th April 1791.^[204, 211] He was known by the title of Capt.

David F died in Searsburg { XE "USA, New York, Schuyler, Searsburg: :Sears, David F (1791–1872)" \f "Place" } on 29th June 1872, at the age of 81.^[204] He was buried in Trumansburg, Tompkins County { XE "USA, New York, Tompkins County, Trumansburg:(42.5423° N, 76.6661° W):Sears, David F (1791–1872)" \f "Place" }.^[204]

More facts and events for David F Sears:

Residence: 1850 Hector, Schuyler { XE "USA, New York, Schuyler, Hector:(42.5006° N, 76.8728° W):Sears, David F (1791–1872)" \f "Place" }^[211]

At the age of 20, Capt David F Sears married **Sally Pine**{ XE "Pine: Sally (1792–1859)" \f "Name" \b \i } on Wednesday, 1st April 1812, in Colchester, Delaware, { XE "USA, New York, Delaware, Colchester:(42.1603° N, 75.0778° W):Sears, David F (1791–1872)" \f "Place" } when she was 19 years old.^[204] They had eleven children: Almoin (1812–1883), George (1814–1883), Hannah (1816–1816), Emeline (1817–1821), Benjamin (1819–1902), Adaline (1822–1891), Caroline (1823–1893), Franklin (1826–1890), Dewitt (1829–), Jane (1830–) and John (1832–1833).

Sally was born in perh, Colchester, { XE "USA, New York, Delaware, Colchester, perh: :Pine, Sally (1792–1859)" \f "Place" } on Tuesday, 25th September 1792.^[204] She reached 66 years of age and died in Searsburg, Schuyler, { XE "USA, New York, Schuyler,

²¹⁰ Ancestry Family Trees (Online publication - Provo, UT, USA: Ancestry.com. Original data: Family Tree files submitted by Ancestry members.), Ancestry.com, Database online. Record for Maria Boardman.
<http://search.ancestry.com/cgi-bin/sse.dll?db=pubmembertrees&h=-1988281135&indiv=try>.

²¹¹ Ancestry.com, 1850 United States Federal Census (Provo, UT, USA, Ancestry.com Operations, Inc., 2009), Ancestry.com, Year: 1850; Census Place: Hector, Tompkins, New York; Roll: M432_606; Page: 426A; Image: 453.

Searsburg: :Pine, Sally (1792–1859)" \f "Place" } on 27th August 1859.^[204] Sally was buried in Trumansburg, Tompkins County{ XE "USA, New York, Tompkins County, Trumansburg:(42.5423° N, 76.6661° W):Pine, Sally (1792–1859)" \f "Place" }.^[204]

Family of Thomas Sears and Sally Lewis{ TC "Thomas Sears and Sally Lewis" \I 3 \f C}

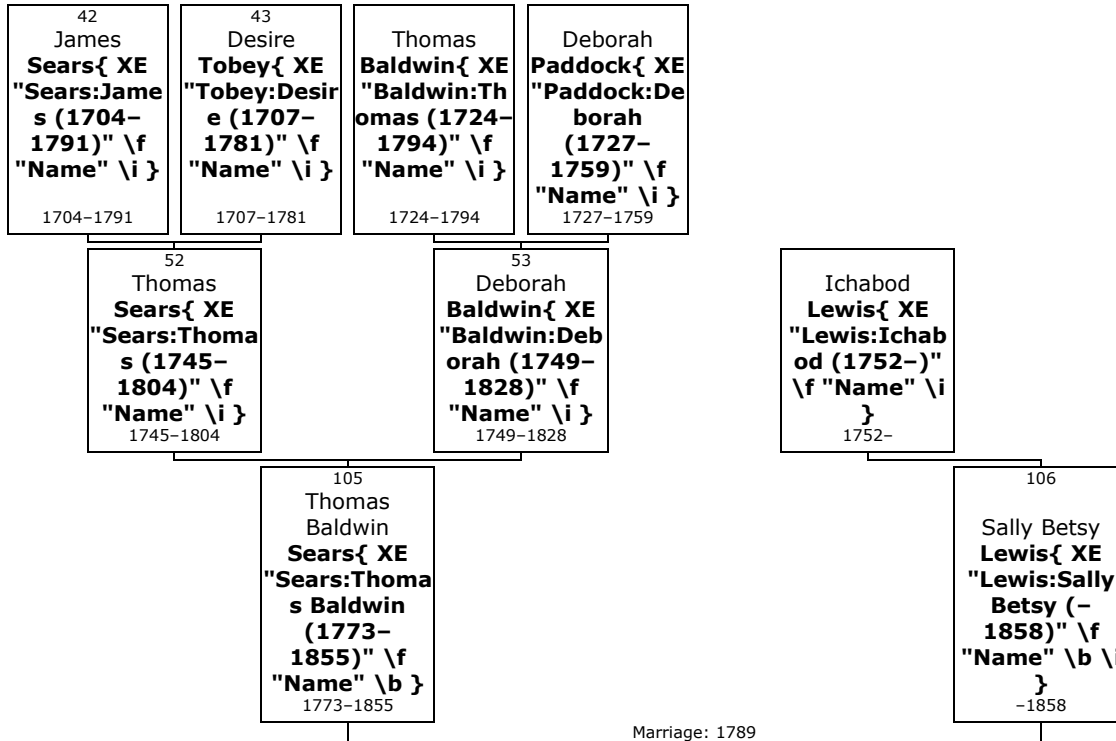

105. Thomas Baldwin⁴ Sears{ XE "Sears:Thomas Baldwin (1773–1855)" \f "Name" \b } (*Capt Thomas³, James²*) was born on Sunday, 21st February 1773, in Southeast, Putnam, New York, USA{ XE "USA, New York, Putnam, Southeast:(41.4054° N, 73.6001° W):Sears, Thomas Baldwin (1773–1855)" \f "Place" }. He was the son of Thomas Sears{ XE "Sears:Thomas (1745–1804)" \f "Name" \i } (52) and Deborah Baldwin{ XE "Baldwin:Deborah (1749–1828)" \f "Name" \i } (53).

Thomas Baldwin died in Carmel{ XE "USA, New York, Putnam, Carmel:(41.4301° N, 73.6801° W):Sears, Thomas Baldwin (1773–1855)" \f "Place" } in March 1855 at the age of 82.

!S P May No 767 b.,m.,d.s.p.,d.

<https://www.wikitree.com/wiki/Sears-2207>

106. Thomas Baldwin married **Sally Betsy Lewis{ XE "Lewis:Sally Betsy (-1858)" \f "Name" \b \i }** on Wednesday, 2nd December 1789. They had no known children. She was the daughter of Ichabod Lewis{ XE "Lewis:Ichabod (1752–)" \f "Name" \i }.

Sally Betsy died on 2nd October 1858. She was buried in Sears Burying Ground, Southeast{ XE "USA, New York, Putnam, Southeast, Sears Burying Ground: :Lewis, Sally Betsy (-1858)" \f "Place" }.

birth could not be Sep 1778

James Sears{ TC "James Sears" \I 3 \f C}

107. James⁴ Sears{ XE "Sears:James (1778–1857)" \f "Name" \b } (*Capt Thomas³, James²*) was born on Tuesday, 24th March 1778, in Southeast, Putnam, New York, USA{ XE "USA, New York, Putnam, Southeast:(41.4054° N, 73.6001° W):Sears, James (1778–1857)" \f "Place" }.^[212, 213] He was the son of Thomas Sears{ XE "Sears:Thomas (1745–1804)" \f "Name" \i } (52) and Deborah Baldwin{ XE "Baldwin:Deborah (1749–1828)" \f "Name" \i } (53).

²¹² "Ancestry Family Tree", Record for Deborah Sears.
<https://www.ancestry.com/family-tree/tree/58968303/person/36462791358>.

²¹³ Ancestry.com, U.S., Find A Grave Index, 1600s-Current (Provo, UT, USA, Ancestry.com Operations, Inc., 2012), Ancestry.com.

James died in March 1857 at the age of 78.^[212] He was buried in Waterloo, Seneca County{ XE "USA, New York, Seneca County, Waterloo:(42.9048° N, 76.8628° W):Sears, James (1778-1857)" \f "Place" }.^[212, 213]

<https://www.wikitree.com/wiki/Sears-1245>

S P May No 769 p. 279

HLS notes James Sears, with his wife, Mehitabel Sherwood, and his family left Putnam county, NY. Their dismissal from the church was noted in 1814. They moved to Wayne co, NY where he bought a farm, known as Horace Hallet's. Later he sold that and settled on the "Stringer" land in the woods. James lived in Galen and Savannah Townships. Mr Sears' first wife died in 1824. In March 1829 he married Lucretia Munsell. According to a document from her daughter, they lived together for only about three months. No divorce record can be found. James then appeared to move westerly into Carroll, Chautauqua co, NY, near his son Eli. Here he bought and sold several pieces of land and also lived for a time in Warren co, PA. During this time a son, James, was born to Mr Sears and his third wife, Phebe. About 1840 he appears to have moved back easterly, settling in Tyre twp, Seneca co, NY.

-----Original Message----- From: ASears720@aol.com [mailto:ASears720@aol.com] Sent: Tuesday, June 11, 2002 10:52 AM To: SEARS-L@rootsweb.com Subject: [[SEARS-L]] Re: [[SEARS-L]] Lucinda SEARS Dear Gilbert, My g-g-g grandfather, James Sears, lived for a time in Wayne Co, NY, from about 1820 to 1850. After his first wife, Mehitabel Sherwood, died in 1824, in Wayne Co, we sort of lost track of him. He seems to have married a Lucretia Munsell in 1829 - don't have any children listed for them. And later he married a Phebe ? and had two children, James, b. 1839, and Smith, b. 1841. No further information on either wife or the children. James is mentioned in Roe's Neighborhood Sketches (I believe, or perhaps some other local history source from Wayne Co.) as "owning the Stringer property". Does any of this sound familiar? Anne Sears

More facts and events for James Sears:

- Residence: 1810 Southeast, Putnam{ XE "USA, New York, Putnam, Southeast:(41.4054° N, 73.6001° W):Sears, James (1778-1857)" \f "Place" }.^[212]
- Residence: 1810 Southeast{ XE "USA, New York, Putnam, Southeast:(41.4054° N, 73.6001° W):Sears, James (1778-1857)" \f "Place" }.^[212]
- Residence: 1820 Galen, Wayne{ XE "USA, New York, Wayne, Galen:(43.0676° N, 76.8802° W):Sears, James (1778-1857)" \f "Place" }.^[212]
- Residence: 1820 Galen{ XE "USA, New York, Wayne, Galen:(43.0676° N, 76.8802° W):Sears, James (1778-1857)" \f "Place" }.^[212]
- Residence: 1820 Galen{ XE "USA, New York, Wayne, Galen:(43.0676° N, 76.8802° W):Sears, James (1778-1857)" \f "Place" }.^[212]
- Residence: 1850 Tyre, Seneca{ XE "USA, New York, Seneca, Tyre:(42.9911° N, 76.8025° W):Sears, James (1778-1857)" \f "Place" }.^[212]
- Residence: 1850 Tyre{ XE "USA, New York, Seneca, Tyre:(42.9911° N, 76.8025° W):Sears, James (1778-1857)" \f "Place" }.^[212]

Marriages with Phebe --Sears, Mehitabel S Sherwood (Page 136) and Lucretia Munsell (Page 140) are known.

Family of James Sears and Phebe --Sears{ TC "James Sears and Phebe --Sears" \I 4 \f C}

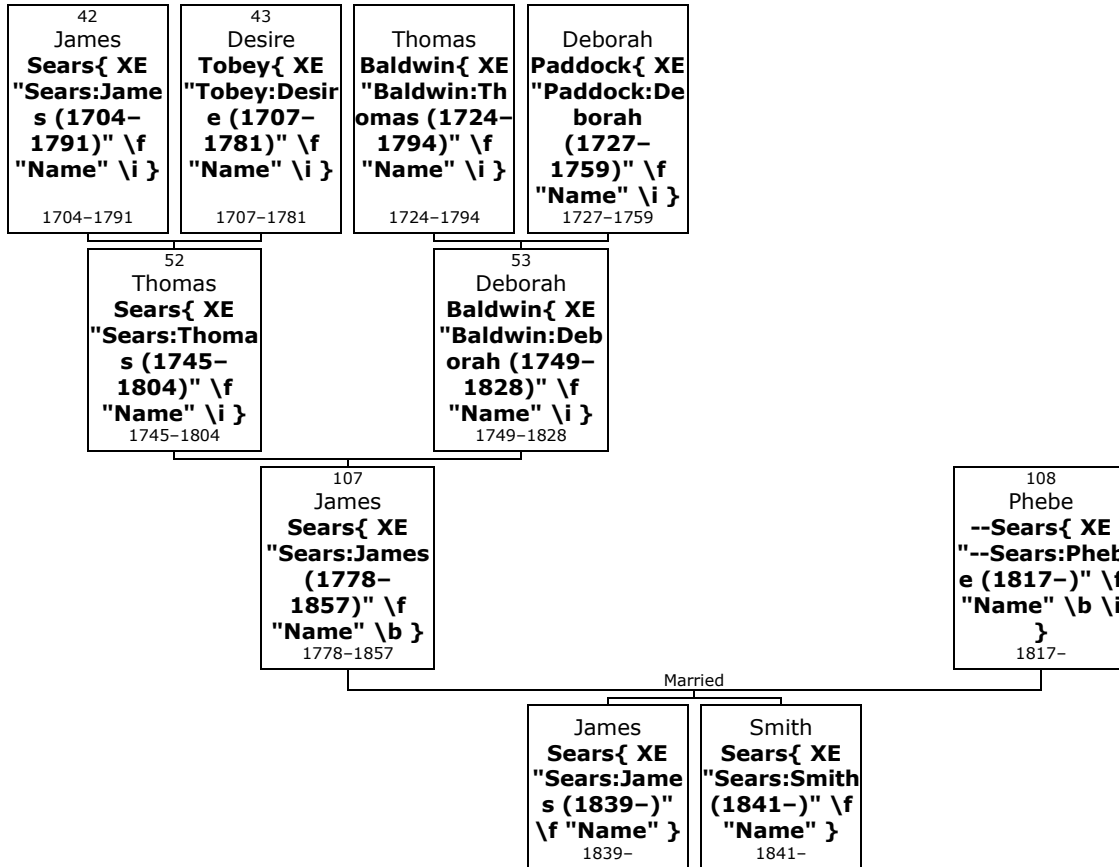

Here are the details about **James Sears**{ XE "Sears:James (1778-1857)" \f "Name" \b } first marriage, with Phebe --Sears. You can read more about James on page 133.

- 108.** James Sears married **Phebe --Sears**{ XE "--Sears:Phebe (1817-)" \f "Name" \b \i }.^[214] They had two sons: James (1839-) and Smith (1841-).

Phebe was born in New York{ XE "USA, New York:(42.7531° N, 74.2224° W):--Sears, Phebe (1817-)" \f "Place" } in 1817.^[214]

More facts and events for Phebe --Sears:

Residence: 1850 Tyre{ XE "USA, New York, Seneca, Tyre:(42.9911° N, 76.8025° W):--Sears, Phebe (1817-)" \f "Place" }.^[214]

Sons of James Sears and Phebe --Sears:

- m I. **James⁵ Sears**{ XE "Sears:James (1839-)" \f "Name" \b } was born in perh{ XE "USA, New York, perh: :Sears, James (1839-)" \f "Place" } in 1839.^[214]
- m II. **Smith Sears**{ XE "Sears:Smith (1841-)" \f "Name" \b } was born in New York{ XE "USA, New York:(42.7531° N, 74.2224° W):Sears, Smith (1841-)" \f "Place" } in 1841.^[215]

More facts and events for Smith Sears:

Residence: 1850 Tyre{ XE "USA, New York, Seneca, Tyre:(42.9911° N, 76.8025° W):Sears, Smith (1841-)" \f "Place" }.^[215]

²¹⁴ "Ancestry Family Tree", Record for James Sears.
<http://search.ancestry.com/cgi-bin/sse.dll?db=1030&h=38348198464&indiv=try>.

²¹⁵ Ancestry.com, 1850 United States Federal Census (Provo, UT, USA, Ancestry.com Operations, Inc., 2009), Ancestry.com, Year: 1850; Census Place: Tyre, Seneca, New York; Roll: 597; Page: 243B. Record for Smith Sears.
<http://search.ancestry.com/cgi-bin/sse.dll?db=1030&h=38348198464&indiv=try>.

Age: 9; AttendedSchool: Y

Family of James Sears and Mehitabel Sherwood{ TC "James Sears and Mehitabel Sherwood" \l 4 \f C}

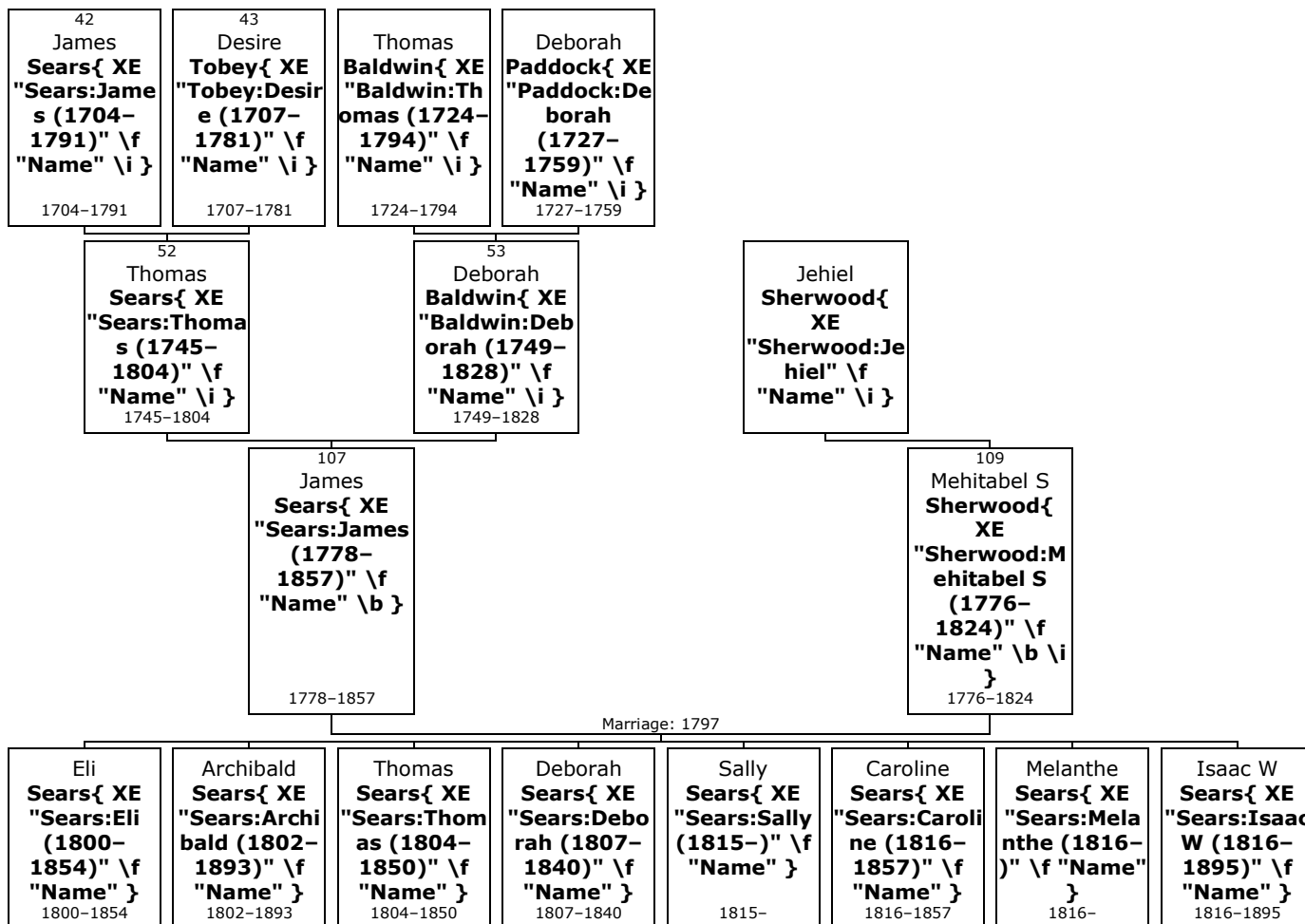

Here are the details about **James Sears**{ XE "Sears:James (1778-1857)" \f "Name" \b } second marriage, with Mehitabel S Sherwood. You can read more about James on page 133.

- 109.** James Sears married **Mehitabel S Sherwood**{ XE "Sherwood:Mehitabel S (1776-1824)" \f "Name" \b \i } on Sunday, 19th November 1797.^[213, 216] They had eight children: Eli (1800-1854), Archibald (1802-1893), Thomas (1804-1850), Deborah (1807-1840), Sally (1815-), Caroline (1816-1857), Melanthe (1816-) and Isaac (1816-1895).

Mehitabel S was born in perh, Southeast,{ XE "USA, New York, Putnam, Southeast, perh: :Sherwood, Mehitabel S (1776-1824)" \f "Place" } in 1776.^[213, 216] She was the daughter of Jehiel Sherwood{ XE "Sherwood:Jehiel" \f "Name" \i }.

Mehitabel S reached 48 years of age and died in Wayne{ XE "USA, New York, Wayne:(43.283° N, 77.0535° W):Sherwood, Mehitabel S (1776-1824)" \f "Place" } in 1824.^[213, 216] She was buried in Wayne{ XE "USA, New York, Wayne:(43.283° N, 77.0535° W):Sherwood, Mehitabel S (1776-1824)" \f "Place" }.^[213, 216]

Children of James Sears and Mehitabel S Sherwood:

- m I. **Eli⁵ Sears**{ XE "Sears:Eli (1800-1854)" \f "Name" \b } was born in Southeast, Putnam,{ XE "USA, New York, Putnam, Southeast:(41.4054° N, 73.6001° W):Sears, Eli (1800-1854)" \f "Place" } in 1800. He died in Carroll, Chautauqua,{ XE "USA, New York, Chautauqua, Carroll:(42.037° N, 79.1217° W):Sears, Eli (1800-1854)" \f "Place" } on 12th June 1854, at the age of 54.

²¹⁶ "Ancestry Family Tree", Record for Caroline Sears.
<http://search.ancestry.com/cgi-bin/sse.dll?db=1030&h=38348198464&indiv=try>.

Eli married **Roxanna Bivens**{ XE "Bivens:Roxanna (1803-1831)" \f "Name" \b \i }. They had three daughters: Adaline (1825-), Mary (1829-1893) and Roxanna (1831-1832).

Roxanna was born in perh, Southeast, Putnam,{ XE "USA, New York, Putnam, Southeast, perh: :Bivens, Roxanna (1803-1831)" \f "Place" } in 1803. She reached 28 years of age and died on 1st November 1831.

Eli Sears married **Harriet Powers**{ XE "Powers:Harriet (-1822)" \f "Name" \b \i } on Saturday, 3rd February 1821. They had no known children.

Harriet died on 3rd April 1822.

Eli married **Minerva Gardner**{ XE "Gardner:Minerva (1812-)" \f "Name" \b \i } in 1833. They had six children: Lansing (1833-1900), Lewis (1835-1916), George (1838-1841), Lawson (1840-1841), William (1843-1928) and Emily (1847-1863).

Minerva was born in perh, Wayne,{ XE "USA, New York, Wayne, perh: :Gardner, Minerva (1812-)" \f "Place" } in 1812.

- m II. **Archibald Sears**{ XE "Sears:Archibald (1802-1893)" \f "Name" \b } was born in Southeast{ XE "USA, New York, Putnam, Southeast:(41.4054° N, 73.6001° W):Sears, Archibald (1802-1893)" \f "Place" } on 23rd February 1802.^[213, 217] He died in Plano, Kendall, Illinois,{ XE "USA, Illinois, Kendall, Plano:(41.6628° N, 88.537° W):Sears, Archibald (1802-1893)" \f "Place" } on 28th October 1893, at the age of 91.^[213, 217] Archibald was buried in Plano, Kendall County{ XE "USA, Illinois, Kendall County, Plano:(41.6628° N, 88.537° W):Sears, Archibald (1802-1893)" \f "Place" }.^[213]



Archibald

Archibald Sears married **Susan Hadden**{ XE "Hadden:Susan (1815-1845)" \f "Name" \b \i } in 1831. They had seven children: Sarah (1831-1892), Caroline (1836-1843), James (1838-1922), Adaline (1840-1851), Cordelia (1841-1842), Julia (1843-1847) and Susan (1845-1845).

Susan was born in Manhattan, New York, New York,{ XE "USA, New York, New York, Manhattan:(40.7834° N, 73.9663° W):Hadden, Susan (1815-1845)" \f "Place" } on Monday, 25th December 1815.

She was the daughter of Morris Hadden{ XE "Hadden:Morris" \f "Name" \i } and Sarah Sally Nelson{ XE "Nelson:Sarah \"Sally\"" \f "Name" \i }. Susan reached 29 years of age and died in Plano, Kendall, Illinois,{ XE "USA, Illinois, Kendall, Plano:(41.6628° N, 88.537° W):Hadden, Susan (1815-1845)" \f "Place" } on 10th June 1845.

<http://trees.ancestry.com/owt/person.aspx?pid=35471579>

Archibald Sears married **Rachel Maria Carver**{ XE "Carver:Rachel Maria (1818-1905)" \f "Name" \b \i }.^[213, 217] They had six children: Charles (1851-1944), Mary (1853-1941), Albert (1856-1917), Alice (1856-1938), Sherman (1859-1949) and Adah (1861-1924).

Rachel Maria was born in Hebron, Tolland, Connecticut,{ XE "USA, Connecticut, Tolland, Hebron:(41.6579° N, 72.3659° W):Carver, Rachel Maria (1818-1905)" \f "Place" } on Monday, 26th October 1818.^[213, 217] She was the daughter of David Taylor{ XE "Carver:David Taylor" \f "Name" \i } and Shirley Tarbox{ XE "Tarbox:Shirley" \f "Name" \i }.

Rachel Maria reached 86 years of age and died in Aurora, Hamilton, Nebraska,{ XE "USA, Nebraska, Hamilton, Aurora:(40.8672° N, 98.0042° W):Carver, Rachel Maria (1818-1905)" \f "Place" } on 10th March 1905.^[213, 217] She was buried in Plano, Kendall, Illinois{ XE "USA, Illinois, Kendall, Plano:(41.6628° N, 88.537° W):Carver, Rachel Maria (1818-1905)" \f "Place" }.^[213]

<http://trees.ancestry.com/owt/person.aspx?pid=2218054>

- m III. **Thomas Sears**{ XE "Sears:Thomas (1804-1850)" \f "Name" \b } was born in perh, Southeast,{ XE "USA, New York, Putnam, Southeast, perh: :Sears, Thomas (1804-1850)" \f "Place" } in 1804. He died in Grafton, Lorain, Ohio,{ XE "USA, Ohio, Lorain,

²¹⁷ Ancestry.com, U.S., Sons of the American Revolution Membership Applications, 1889-1970 (Provo, UT, USA, Ancestry.com Operations, Inc., 2011), Ancestry.com.

Grafton:(41.2726° N, 82.0546° W):Sears, Thomas (1804–1850)" \f "Place" } in 1850 at the age of 46.

Thomas Sears married **Hannah Betsy Sheldon**{ XE "Sheldon:Hannah \"Betsy\" (1807–)" \f "Name" \b \i }. They had two sons: Orson (1828–ca.1900) and Thomas (1835–1905).

Betsy was born in New York{ XE "USA, New York:(42.7531° N, 74.2224° W):Sheldon, Hannah \"Betsy\" (1807–)" \f "Place" } on Thursday, 27th August 1807.

- f IV. **Deborah Sears**{ XE "Sears:Deborah (1807–1840)" \f "Name" \b } was born in perh{ XE "USA, New York, Putnam, Southeast, perh: :Sears, Deborah (1807–1840)" \f "Place" } in 1807.^[212] She died in Savannah, Wayne,{ XE "USA, New York, Wayne, Savannah:(43.0672° N, 76.76° W):Sears, Deborah (1807–1840)" \f "Place" } on 6th October 1840, at the age of 33.^[212] Deborah was buried in North Rose{ XE "USA, New York, Wayne, North Rose:(43.1856° N, 76.8928° W):Sears, Deborah (1807–1840)" \f "Place" }.^[212]

At the age of 20, Deborah Sears married **Rial Betts**{ XE "Betts:Rial (1804–1887)" \f "Name" \b \i } on Wednesday, 31st October 1827, when he was 23 years old.^[212] They had four children: Leander (1831–1909), Nathaniel (1833–), Matilda (1835–1851) and Delos (1837–1919).

Rial was born in Washington{ XE "USA, New York, Washington:(43.3201° N, 73.4306° W):Betts, Rial (1804–1887)" \f "Place" } on Thursday, 15th March 1804.^[212] He reached 82 years of age and died in Savannah{ XE "USA, New York, Wayne, Savannah:(43.0672° N, 76.76° W):Betts, Rial (1804–1887)" \f "Place" } on 4th March 1887.^[212] Rial was buried in Savannah{ XE "USA, New York, Wayne, Savannah:(43.0672° N, 76.76° W):Betts, Rial (1804–1887)" \f "Place" }.^[212]

- f V. **Sally Sears**{ XE "Sears:Sally (1815–)" \f "Name" \b } was born in perh{ XE "USA, New York, Putnam, Southeast, perh: :Sears, Sally (1815–)" \f "Place" } in 1815.

Sally Sears married **Robert Bennett**{ XE "Bennett:Robert" \f "Name" \b \i }. They had one daughter: Henrietta (1840–).

- f VI. **Caroline Sears**{ XE "Sears:Caroline (1816–1857)" \f "Name" \b } was born in perh{ XE "USA, New York, Putnam, Southeast, perh: :Sears, Caroline (1816–1857)" \f "Place" } in 1816.^[216, 218] She died in Tyre, Seneca,{ XE "USA, New York, Seneca, Tyre:(42.9911° N, 76.8025° W):Sears, Caroline (1816–1857)" \f "Place" } on 22nd February 1857, at the age of 41.^[216, 218] is it supposed to be Tyre, NY? Her estate was probated on 2nd November 1857, in Seneca{ XE "USA, New York, Seneca:(42.786° N, 76.8287° W):Sears, Caroline (1816–1857)" \f "Place" }.^[218]

- f VII. **Melanthe Sears**{ XE "Sears:Melanthe (1816–)" \f "Name" \b } was born in perh{ XE "USA, New York, Putnam, Southeast, perh: :Sears, Melanthe (1816–)" \f "Place" } in 1816.^[219]

More facts and events for Melanthe Sears:

Residence: 1870 South Butler{ XE "USA, New York, Wayne, South Butler:(43.1314° N, 76.7661° W):Sears, Melanthe (1816–)" \f "Place" }.^[219]
Age: 54; RealEstateValue: 300; Occupation: Keeping House

Melanthe married **(unknown given name) Overacre**{ XE "Overacre: (1812–)" \f "Name" \b \i } in South Butler{ XE "USA, New York, Wayne, South Butler:(43.1314° N, 76.7661° W):Sears, Melanthe (1816–)" \f "Place" }. They had one son: George (1848–).

(unknown given name) was born in perh.,South Butler, Butler,{ XE "USA, New York, Wayne, Butler, South Butler, perh.: :Overacre, (1812–)" \f "Place" } in 1812.

²¹⁸ Ancestry.com, New York, Wills and Probate Records, 1659-1999 (Provo, UT, USA, Ancestry.com Operations, Inc., 2015), Ancestry.com, Probate Records; Author: New York. Surrogate's Court (Seneca County); Probate Place: Seneca, New York. Record for Caroline Sears. <http://search.ancestry.com/cgi-bin/sse.dll?db=1030&h=38348198464&indiv=try>.

²¹⁹ Ancestry.com, 1870 United States Federal Census (Provo, UT, USA, Ancestry.com Operations, Inc., 2009), Ancestry.com, Year: 1870; Census Place: Butler, Wayne, New York; Roll: M593_1112; Page: 93A; Family History Library Film: 552611. Record for Malintha Overacker. <http://search.ancestry.com/cgi-bin/sse.dll?db=1030&h=38348198464&indiv=try>.

m VIII. **Isaac W Sears**{ XE "Sears:Isaac W (1816-1895)" \f "Name" \b } was born in Connecticut{ XE "USA, Connecticut:(41.5735° N, 72.7383° W):Sears, Isaac W (1816-1895)" \f "Place" } on 14th October 1816.^[220] He died in Chatham{ XE "USA, Ohio, Medina, Chatham:(41.0995° N, 82.0245° W):Sears, Isaac W (1816-1895)" \f "Place" } on 20th March 1895, at the age of 78.

More facts and events for Isaac W Sears:

Residence: 1860 Chatham, Chatham Center{ XE "USA, Ohio, Medina, Chatham Center, Chatham: :Sears, Isaac W (1816-1895)" \f "Place" }^[220]

Age: 44; Occupation: Farmer; PersonalEstateValue: 638; RealEstateValue: 2660

Residence: 1870 Ohio{ XE "USA, Ohio:(40.2083° N, 81.325° W):Sears, Isaac W (1816-1895)" \f "Place" }

Residence: 1880 Chatham, Medina, Ohio{ XE "USA, Ohio, Medina, Chatham:(41.0995° N, 82.0245° W):Sears, Isaac W (1816-1895)" \f "Place" }

At the age of 25, Isaac W Sears married **Martha A. Robinson**{ XE "Robinson:Martha A. (1823-1901)" \f "Name" \b \i } on Monday, 3rd January 1842, when she was 18 years old. They had three children: Christiane (1842-), Helen (1852-1872) and James (1855-1922).

Martha A. was born in Massachusetts{ XE "USA, Massachusetts:(42.1562° N, 71.5662° W):Robinson, Martha A. (1823-1901)" \f "Place" } on Friday, 28th March 1823. She reached 78 years of age and died on 4th April 1901.

Family of James Sears and Lucretia Munsell{ TC "James Sears and Lucretia Munsell" \I 4 \f C}

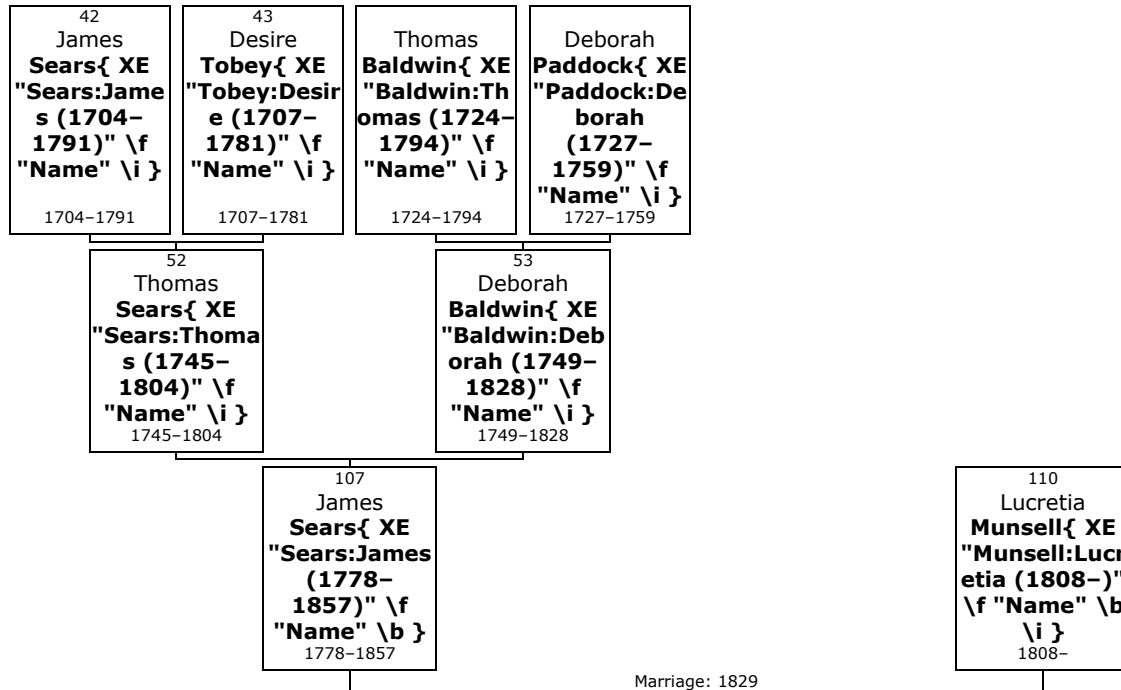

Here are the details about **James Sears**{ XE "Sears:James (1778-1857)" \f "Name" \b } third marriage, with Lucretia Munsell. You can read more about James on page 133.

²²⁰ Ancestry.com, 1860 United States Federal Census (Provo, UT, USA, Ancestry.com Operations, Inc., 2009), Ancestry.com, Year: 1860; Census Place: Chatham, Medina, Ohio; Page: 82; Family History Library Film: 805007. Record for Isaac Sears. <http://search.ancestry.com/cgi-bin/sse.dll?db=1030&h=38348198464&indiv=try>.

- 110.** James Sears married **Lucretia Munsell**{ XE "Munsell:Lucretia (1808-)" \f "Name" \b \i } in March 1829. They had no known children.

Lucretia was born in perh, Southeast,{ XE "USA, New York, Putnam, Southeast, perh: :Munsell, Lucretia (1808-)" \f "Place" } in 1808.

Family of Archibald Sears and Polly Sellick{ TC "Archibald Sears and Polly Sellick" \I 3 \f C}

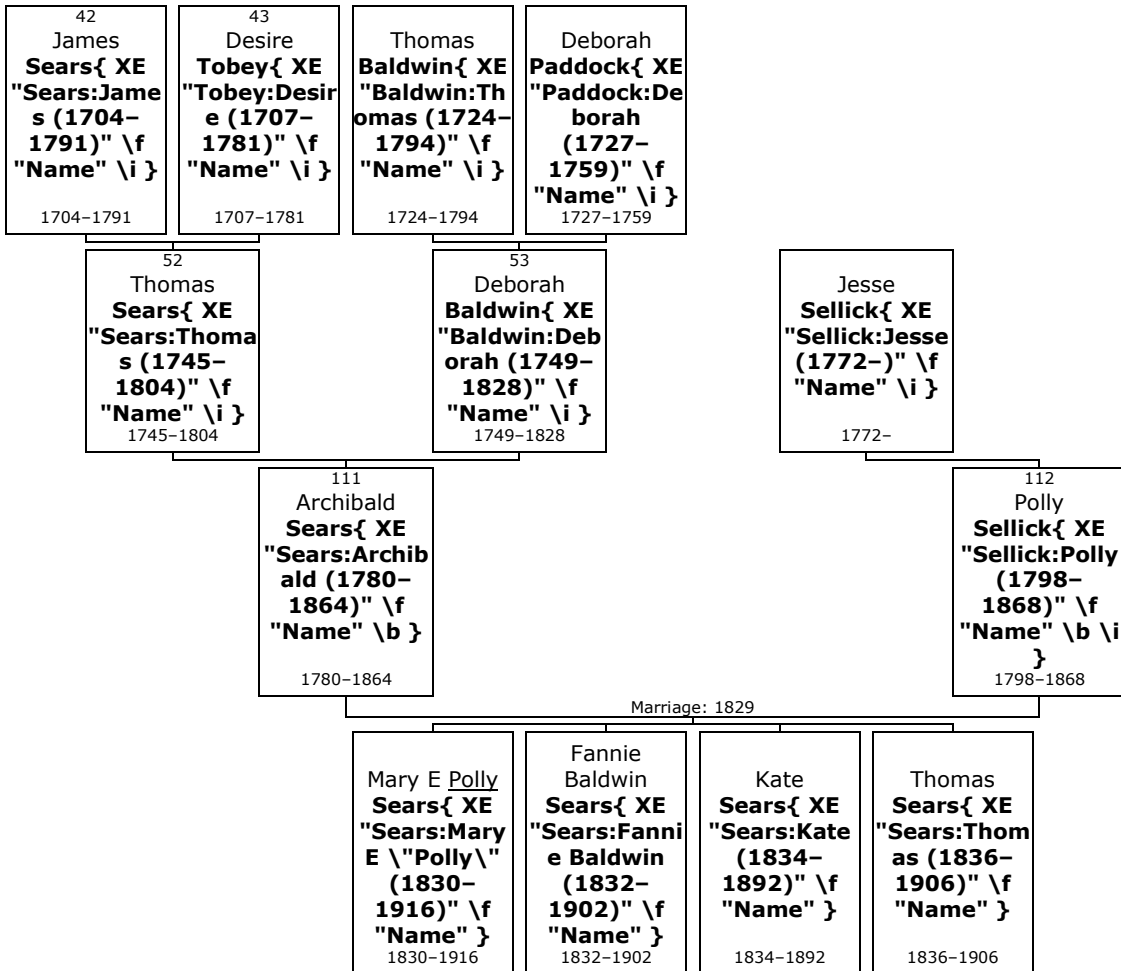

- 111.** **Archibald⁴ Sears**{ XE "Sears:Archibald (1780-1864)" \f "Name" \b } (*Capt Thomas³, James²*) was born on Tuesday, 8th August 1780, in Carmel, Putnam, New York, USA{ XE "USA, New York, Putnam, Carmel:(41.4301° N, 73.6801° W):Sears, Archibald (1780-1864)" \f "Place" }.^[221] He was the son of Thomas Sears{ XE "Sears:Thomas (1745-1804)" \f "Name" \i } (52) and Deborah Baldwin{ XE "Baldwin:Deborah (1749-1828)" \f "Name" \i } (53).

Archibald died in Southeast{ XE "USA, New York, Putnam, Southeast:(41.4054° N, 73.6001° W):Sears, Archibald (1780-1864)" \f "Place" } on 27th October 1864, at the age of 84.^[221] He was buried in Sears Burying Ground, Southeast{ XE "USA, New York, Putnam, Southeast, Sears Burying Ground: :Sears, Archibald (1780-1864)" \f "Place" }.^[221]

84-2-19, Sears Burying Gd, South East, NY

!S P May p.279 Archibald Sears lived on part of the old homestead in Southeast Putnam co., NY and joined the church there at the age of 80.

<https://www.wikitree.com/wiki/Sears-2206>

NYGenWeb Putnam County, New York History of Putnam County NYGenWeb Chapter XXII Town of

²²¹ Ancestry.com, U.S., Find A Grave Index, 1600s-Current (Provo, UT, USA, Ancestry.com Operations, Inc., 2012), Ancestry.com.

Southeast The cemetery at Doansburg is generally known as the "Sears Burying Ground," from its being near the farm and homestead of Archibald Sears, who was during a long life a well known citizen of the town. The ground was a part of the estate of Frederick Philipse, and was given by him for burial purposes. In the field book of survey of Lot 8, of Philipse Patent, it is described: "Begins at the middle of the road leading from Archibald Sears to Lyman Sherwoods, and the N. E. corner of Robert Penney, thence N. 5o W. 7 chains 60 links along the middle of the road; thence S. 32-3/4 W. S. 74 along another road and turnpike leading to Sing Sing; thence S. 87o E. 5.60 along said Sears and Penney to the beginning, containing 2 acres 8 rods; deed of gift."

Within this enclosure rest the early settlers of the neighborhood, and six minister of the parish have found here their last home. Many of the inscriptions are growing illegible, and to preserve them seems a duty not to be neglected. The oldest tombstone is erected to the memory of the wife of Rev. Elisha Kent, and a copy is given in the sketch of the church history: Thomas Paddock, died June 11th, 1799, age, 77; Mary, wife, July 8th, 1778, 55; Peter Paddock, April 10th, 1760, 63; Sarah wife, Oct. 22d, 1776, 80; Peter Chapman, Oct. 8th, 176, 33; David Crosby, Nov. 16th, 1816, 79; Bethia, wife, July 2d, 1776, 41; Thomas Chapman, June 6th, 1827, 68; Samuel Lawrence, Nov. 10th, 1831, 84; Thankful, wife, Aug. 30th, 1811, 52; James Paddock, Aug. 9th, 1761, 67; Dr. Stephen C. Barnum, Aug. 11th, 1849, 60; Clarrissa, wife, May 14th, 1834, 40; Hannah, wife, April 14th, 1861, 66; Peter Crosby, Nov. 9th, 1831, 68; Ruth, wife, July 31st, 1830, 67; Zebulon Crane, Aug. 17th, 1848, 60; Weltha, wife, Sept. 6th, 1860, 71; Zebulon Crane, Dec. 31st, 1814, 68; Hannah, wife of Nathan Gray, 1789, 78; Charles C. Crosby, Nov. 1848, 51; Jane, wife, Dec. 9th, 1857, 64; Nehemiah Jones, Dec. 18th, 1805, 71; Peter Hall, July 2d, 1795, 75; Abigail Hall, 86; Thomas Sears, April 26th, 1804, 59; Deborah, wife, Sept. 13th, 1828, 79; James Foster, Aug. 18th, 1814, 81; Bathsheba, wife, Sept. 12th, 1820, 72; Thankful, wife, July 2th, 1772, 31; Edmond Foster, Esq., May 5th, 1845, 77; Sarah, wife, March 1st, 1847, 77; Ruth Doane, Sept. 30th, 1801, 69; John Raymond, Feb. 15th, 1829, 85; Mary, wife, July 27th, 1787, 40; Stephen Waring, Jan. 22d, 1815, 43; John Waring, Feb. 17th, 1809, 73; John Waring, jr., April 15th, 1812, 43; Joanna Waring, April 28th, 1779, 48; Susannah Waring, Aug. 10th, 1837, 76; Stephen Paddock, May 2d, 1832, 82; Joanna Williams, April 5th, 1867, 87; Mary Waring, Dec. 13th, 1839, 89; Susan E. Williams, Oct. 25th, 1872, 60; Elnathan Doane, Aug. 13th, 1806, 59; Phebe, wife, June 10th, 1788, 32; Elnathan Doane, Nov. 11th, 1845, 53; Edmond Doane, July 6th, 1825, 49; Demas Doane, July 23d, 1830, 44; Roxanna, wife, June 7th, 1838, 45; Mr. Ezekiel Burgis, Feb. 16th, 1784, 79; Sarah, wife, Dec. 18th, 1774, -; Simeon Perry, Sept. 8th, 1853, 94; Ebenezer Perry, May 2d, 1862, 63; Rd. Daniel Reed, Feb. 6, 1854, 83; Sarah, wife, Oct. 22d, 1856, 79; Archibald Penney, Oct. 1st, 1840, 67; Henrietta, wife, Dec. 15th, 1854, 69; Robert Penney, April 28th, 1836, 60; William Penney, jr., Aug. 8th, 1807, 65; Sarah, wife, March 23d, 1814, 74; Capt. John Penney, Sept. 27th, 1826, 69; Desire Crosby, wife, June 5th, 1849, 90; Capt. Azor Barnum, Sept. 9th, 1807, 61; Azor Barnum, jr., April 28th, 1816, 71; Sally, wife, Oct. 13th, 1803, 17; Eli Crosby, Nov. 22d, 1827, 78; Jonathan Barnum, Oct. 7th, 1843, 83; Judge Stephen Barnum, July 12th, 1825, 64; Maj. Joshua Barnum, jr., June 4th, 1818, 53; Thankful, wife, Nov. 30th, 1841, 73; William Penney, Feb. 21st, 1786, 70; Capt. Joshua Barnum, Oct. 23d, 1822, 85; Adah, wife, April 1th, 1810, 73; Moses Crosby, July 2d, 1821, 66; Abner Crosby, May 5th, 1813, 67; Ruth, wife, Oct. 1st, 1816, 67; David Crosby, Oct. 20th, 1793, 85; Reliance, wife, Feb. 25th, 1788, 75; Dea. Elkanah Young, May 20th, 1809, 59; Huldah, wife, Feb. 14th, 1830, 73; Samuel Bangs, March 1st, 1787, 64; John Bangs, March 30th, 1784, 35; Hannah, wife, Oct. 29th, 1758, 33; Elihu Gage, Aug. 14th, 1802, 76; Grace, Feb. 24th, 1814, 78; Rebecca, wife of Thomas Gage, Dec. 5th, 1759, 53; Mercy, wife of Theodorus Crosby, Aug. 20th, 1811, 70; Oliver, son of Henry Hoyt, April 29th, 1792, 2; Lydia, wife of Joshua Crosby, Sept. 10th, 1781, 67; Hannah, daughter of Joshua Crosby, March, 1757, 13; Naomai, daughter of Capt. Burgis, March 1st, 1784, 22.

The Sears farm, which lies directly opposite to the burying ground and a part of which is on the north side of the road, is probably the one owned by Zebulon Bass, in 1766. It was sold to Archibald Sears, July 17th, 1815, by Frederick Philipse. The land to the east of the Oblong line, and adjoining the homestead, is part of Oblong Lot No. 10. The north part of this lot seems to have belonged to the Crosby family from the earliest times, and was probably first owned by Joshua Crosby in 1749. East of Doansburg, on the east bank of the Croton River is a locality known as De Forest's Corners. This derived its name from David L. De Forest, a prominent citizen of former times. He was one of the builders of the church in 1794. He died November 26th, 1819, at the age of 57. He was a liberal supporter of the church and left a thousand dollars to it in his will. His home was a large brick house still standing here, and owned by some of his descendants. On the west bank of the Croton, to the north of the road from Doansburg, is the original homestead of the Barnum family. The ancestor of this family was Capt. Joshua Barnum, who came from the town of Danbury, Conn., and settled here. This farm is a part of Lot 12 on the Oblong, and remains in the possession of his descendants. About a mile west of the church at Doansburg is the farm which, at the close of the last century, was owned by Peter Crosby, who was a prominent citizen. Owing to financial difficulties, the farm was sold at sheriff's sale, to Edmund Doane, May 2d, 1821, and by him to William K. Comstock, May 3d. It

was sold May 10th, 1824, to Samuel Brewster, and is now owned by his son, Frederick D. Brewster. The ancient division line between Lot 9 of the Philipse Patent, which belonged to Roger Morris and his wife, and Lot 8, which belonged to Philipse Philipse, runs just south of Doansburg. The east corner is, as the old survey states, on the Oblong line on the " west side of a rocky hill." This point is 15 chains and 40 links east of the road, and from this place the line runs west and is the dividing line between the homestead and farm of Lyman Sherwood on the north, and the house and farm of Benjamin Foster on the south. The line is about one quarter of a mile south of the burying ground. Beyond this it forms the boundary between the farms of Frederick Brewster on the north, and Mrs. Robert Newman on the south. To the west of the road on Brewster Hill, it runs across the farm of Morgan Townsend. Here the line crosses Lake Tonetta (south of the middle) and can be distinctly traced to the west. At the Tilly Foster Mine, it forms the line between Theodore Kelly on the north, and the estate of Theodore Reed on the south, and is the north boundary of the land belonging to the Tilly Foster mine Company. The line crosses the reservoir at the east end of the bridge, and forms the north boundary of the school house lot in District No. 10. Beyond this a line of stone wall extends to the west corner of the two lots, on the town line of Carmel, which is the east line of Lot No. 6 in the Philipse Patent. At this point stands a walnut tree, which may have sprung from the root of the one mentioned in the original survey, which is described as "standing on the south side of a hill near an old meeting house." The land on both sides of the line is owned by Elijah Fowler. These pages are maintained by the Putnam County Coordinator, Cathy Horn. 1998-20001 Cathy Horn. All Rights Reserved. NYGenWeb's Putnam County URL: <http://www.rootsweb.com/~nyputnam/> <http://www.rootsweb.ancestry.com/~nyputnam/history/chapXXII/440-443.htm>

- 112.** At the age of 48, Archibald married **Polly Sellick**{ XE "Sellick:Polly (1798-1868)" \f "Name" \b \i } on Sunday, 25th January 1829, in Southeast{ XE "USA, New York, Putnam, Southeast:(41.4054° N, 73.6001° W):Sears, Archibald (1780-1864)" \f "Place" } when she was 30 years old. They had four children: Polly (1830-1916), Fannie (1832-1902), Kate (1834-1892) and Thomas (1836-1906).

Polly was born in was Dutchess, Southeast,{ XE "USA, New York, Putnam, Southeast, was Dutchess: :Sellick, Polly (1798-1868)" \f "Place" } on Wednesday, 11th July 1798. She was the daughter of Jesse Sellick{ XE "Sellick:Jesse (1772-)" \f "Name" \i }.

Polly reached 69 years of age and died on 26th May 1868. She was buried in 69-10-24, Sears Burying Gd{ XE "USA, New York, Putnam, Southeast, Sears Burying Gd, 69-10-24: :Sellick, Polly (1798-1868)" \f "Place" }.

Children of Archibald Sears and Polly Sellick:

- f I. **Mary E Polly⁵ Sears**{ XE "Sears:Mary E \"Polly\" (1830-1916)" \f "Name" \b } was born in Southeast{ XE "USA, New York, Putnam, Southeast:(41.4054° N, 73.6001° W):Sears, Mary E \"Polly\" (1830-1916)" \f "Place" } on 30th May 1830. She died on 3rd February 1916, at the age of 85. Polly was buried. Patterson Baptist Church Cemetery.
-
- Polly
- Polly married **Richard Towner Haviland**{ XE "Haviland:Richard Towner (1829-1908)" \f "Name" \b \i }. They had three children: Frederick (1854-1856), Gertrude (1858-) and Edward (1864-).
- Richard Towner was born in Patterson{ XE "USA, New York, Putnam, Patterson:(41.5136° N, 73.6067° W):Haviland, Richard Towner (1829-1908)" \f "Place" } on Monday, 23rd February 1829. He was the son of Benjamin Vail Haviland{ XE "Haviland:Benjamin Vail" \f "Name" \i } and Emma C Towner{ XE "Towner:Emma C" \f "Name" \i }.
- Richard Towner reached 78 years of age and died in 1908.
- f II. **Fannie Baldwin Sears**{ XE "Sears:Fannie Baldwin (1832-1902)" \f "Name" \b } was born in perh, Southeast,{ XE "USA, New York, Putnam, Southeast, perh: :Sears, Fannie Baldwin (1832-1902)" \f "Place" } on 26th May 1832. She died on 17th August 1902, at the age of 70. Fannie Baldwin was buried in Sears Burying Ground{ XE "USA, New York, Putnam, Southeast, Sears Burying Ground: :Sears, Fannie Baldwin (1832-1902)" \f "Place" }.
- f III. **Kate Sears**{ XE "Sears:Kate (1834-1892)" \f "Name" \b } was born in perh{ XE "USA, New York, Putnam, Southeast, perh: :Sears, Kate (1834-1892)" \f "Place" } on 27th September 1834. She died on 19th January 1892, at the age of 57. Kate was buried. Sears Burying Ground.
- Kate Sears married **Rev Roswell Smith**{ XE "Smith:Roswell (1830-)" \f "Name" \b \i } in October 1866. They had no known children.

Roswell was born in 1830.

- m IV. **Thomas Sears**{ XE "Sears:Thomas (1836-1906)" \f "Name" \b } was born in Southeast{ XE "USA, New York, Putnam, Southeast:(41.4054° N, 73.6001° W):Sears, Thomas (1836-1906)" \f "Place" } on 16th April 1836. He died in 1906 at the age of 69.

Family of Sophia Sears and Archibald Young{ TC "Sophia Sears and Archibald Young" \I 3 \f C}

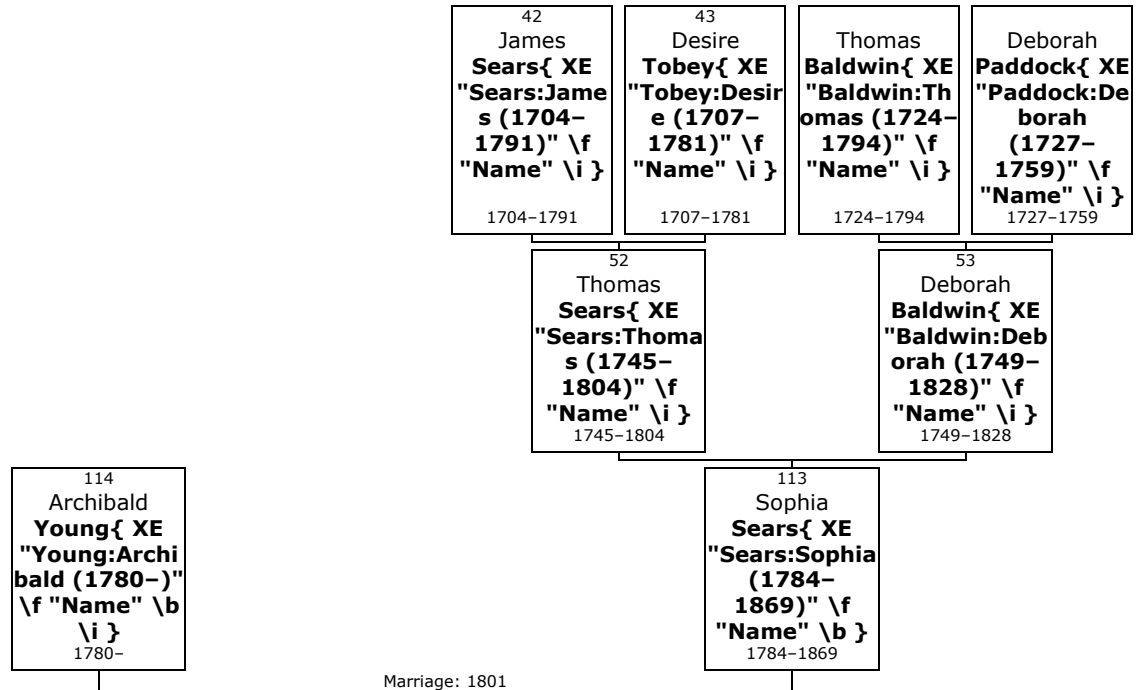

- 113.** **Sophia⁴ Sears**{ XE "Sears:Sophia (1784-1869)" \f "Name" \b } (*Capt Thomas³, James²*) was born on Wednesday, 12th May 1784, in Southeast, Putnam, New York, USA{ XE "USA, New York, Putnam, Southeast:(41.4054° N, 73.6001° W):Sears, Sophia (1784-1869)" \f "Place" }. She was the daughter of Thomas Sears{ XE "Sears:Thomas (1745-1804)" \f "Name" \i } (52) and Deborah Baldwin{ XE "Baldwin:Deborah (1749-1828)" \f "Name" \i } (53).

Sophia died on 12th April 1869, at the age of 84.

<https://www.wikitree.com/wiki/Sears-4776>

- 114.** Sophia married **Archibald Young**{ XE "Young:Archibald (1780-)" \f "Name" \b \i } on Tuesday, 28th April 1801. They had no known children.

Archibald was born in perh, Southeast,{ XE "USA, New York, Putnam, Southeast, perh: :Young, Archibald (1780-)" \f "Place" } in 1780.

!S.P. May p.178 Arch. Young of Bath, LI and Benj. and Elkanah Young of Phelps, NY are descendants

Family of Isaac Sears and Mary Sears{ TC "Isaac Sears and Mary Sears" \I 3 \f C}

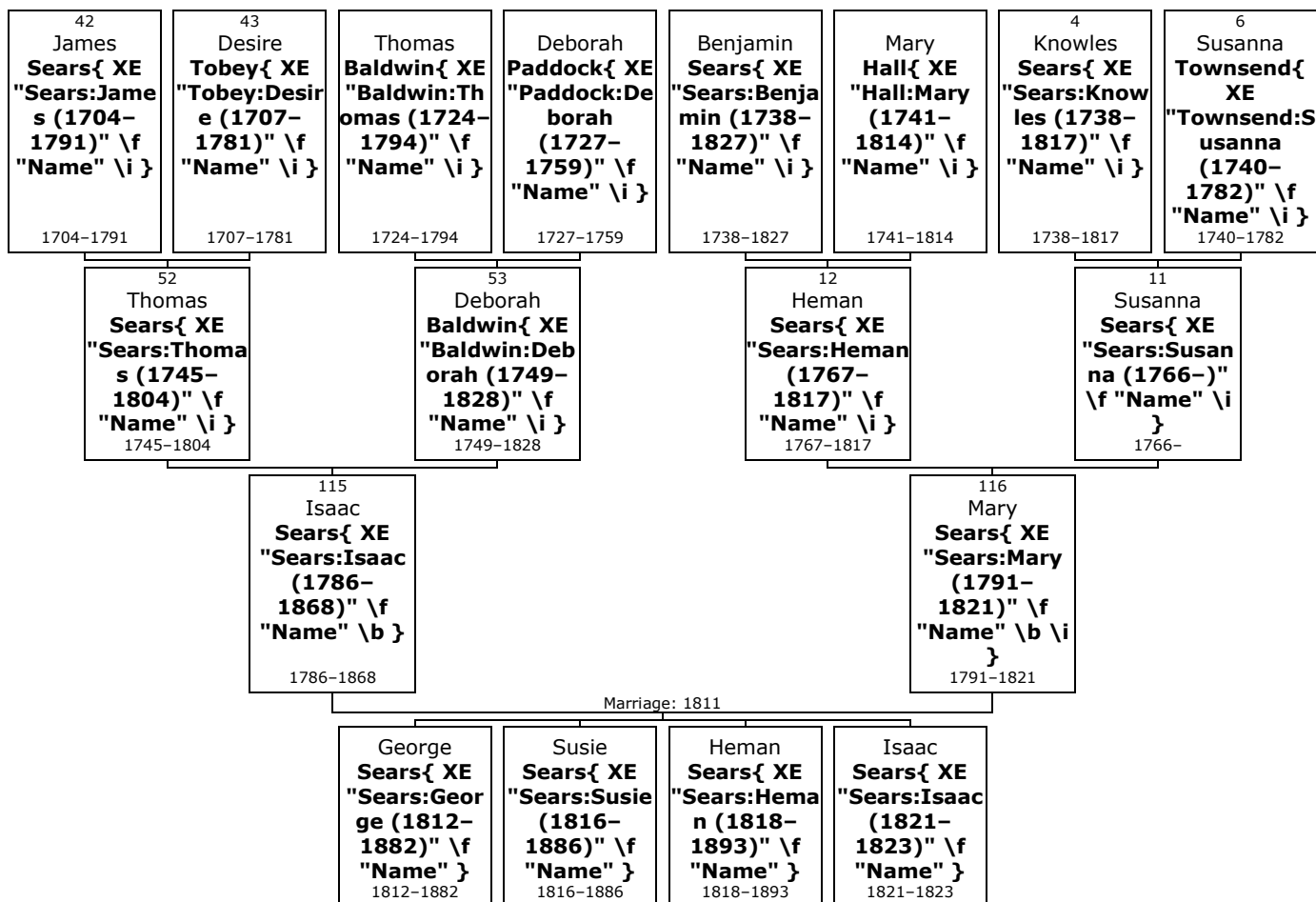

- 115.** Isaac⁴ Sears{ XE "Sears:Isaac (1786-1868)" \f "Name" \b } (*Capt Thomas³, James²*) was born on Sunday, 23rd July 1786, in Southeast, Dutchess, New York, USA{ XE "USA, New York, Dutchess, Southeast: :Sears, Isaac (1786-1868)" \f "Place" }.^[222, 223] He was the son of Thomas Sears{ XE "Sears:Thomas (1745-1804)" \f "Name" \i } (52) and Deborah Baldwin{ XE "Baldwin:Deborah (1749-1828)" \f "Name" \i } (53).

Isaac died in Berlin Heights, Ohio,{ XE "USA, Ohio, Berlin Heights: :Sears, Isaac (1786-1868)" \f "Place" } in January 1868 at the age of 81.^[222] He was buried in Milltown Cemetery, Southeast, Putnam, New York{ XE "USA, New York, Putnam, Southeast, Milltown Cemetery: :Sears, Isaac (1786-1868)" \f "Place" }.

<https://www.wikitree.com/wiki/Sears-2208>

* His father's will: "New York Probate Records, 1629-1971," images, FamilySearch (<https://familysearch.org/pal:/MM9.3.1/TH-1942-28664-41501-23?cc=1920234> : accessed 22 March 2016), Dutchess > Wills 1796-1806 vol B > image 287 of 418; county courthouses, New York.

*Lineage Book of the Charter Members of the DAR Vol 085, p. 308 re Mrs Grace Sears Snyder #84795

- 116.** Isaac married Mary Sears{ XE "Sears:Mary (1791-1821)" \f "Name" \b \i } on Sunday, 12th May 1811.^[222] They had four children: George (1812-1882), Susie (1816-1886), Heman (1818-1893) and Isaac (1821-1823).

²²² "Ancestry Family Tree", Record for George Sears-<https://www.ancestry.com/family-tree/tree/112169379/person/232092345437>.
<https://search.ancestry.com/cgi-bin/sse.dll?db=1030&h=232092345437&indiv=try>.

²²³ Ancestry.com, North America, Family Histories, 1500-2000 (Provo, UT, USA, Ancestry.com Operations, Inc., 2016), Ancestry.com, Book Title: Lineage Book of the Charter Members of the DAR Vol 085. [Source citation includes one media item]

Mary was born in Southeast, Dutchess, { XE "USA, New York, Dutchess, Southeast: :Sears, Mary (1791–1821)" \f "Place" } in 1791.^[222] She was the daughter of Heman Sears { XE "Sears:Heman (1767–1817)" \f "Name" \i } (12) and Susanna Sears { XE "Sears:Susanna (1766–)" \f "Name" \i } (11).

Mary reached 30 years of age and died on 11th April 1821.^[222] She was buried in Milltown Cemetery, Southeast, Putnam { XE "USA, New York, Putnam, Southeast, Milltown Cemetery: :Sears, Mary (1791–1821)" \f "Place" }.

!S P May No 1016

<https://www.wikitree.com/wiki/Sears-5548>

Children of Isaac Sears and Mary Sears:

- m I. **George⁵ Sears** { XE "Sears:George (1812–1882)" \f "Name" \b } was born in Southeast { XE "USA, New York, Putnam, Southeast:(41.4054° N, 73.6001° W):Sears, George (1812–1882)" \f "Place" } in 1812.^[222, 224] He served in the military in Indianapolis, Indiana, { XE "Indiana, Indianapolis: :Sears, George (1812–1882)" \f "Place" } on 2nd December 1863.^[224]
- George died in New York { XE "USA, New York:(42.7531° N, 74.2224° W):Sears, George (1812–1882)" \f "Place" } in 1882 at the age of 70.^[222, 224] He was buried in Brooklyn, Kings, New York { XE "USA, New York, Kings, Brooklyn:(40.65° N, 73.95° W):Sears, George (1812–1882)" \f "Place" }.^[224]
- More facts and events for George Sears:
- | | |
|---|---|
| Residence: 1850 | Hancock, Illinois { XE "USA, Illinois, Hancock:(40.4021° N, 91.1689° W):Sears, George (1812–1882)" \f "Place" }. ^[222, 224] |
| Residence: 3 rd July 1855 | Durham, Hancock { XE "USA, Illinois, Hancock, Durham:(40.5967° N, 91.0895° W):Sears, George (1812–1882)" \f "Place" }. ^[224] |
| Residence: 18 th August 1860 | Durham { XE "USA, Illinois, Hancock, Durham:(40.5967° N, 91.0895° W):Sears, George (1812–1882)" \f "Place" }. ^[222, 224] |
| Residence: 1880 | Durham { XE "USA, Illinois, Hancock, Durham:(40.5967° N, 91.0895° W):Sears, George (1812–1882)" \f "Place" }. ^[222, 224] |
- George married **Easter Hester Somers** { XE "Somers:Easter Hester (1823–1859)" \f "Name" \b \i } on Saturday, 4th June 1836, in Hancock { XE "USA, Illinois, Hancock:(40.4021° N, 91.1689° W):Sears, George (1812–1882)" \f "Place" }.^[222, 224] They had five children: Susan (1839–1888), George (1844–1911), Adaline (1844–1933), Laura (1848–1924) and Albert (1855–1913).
- Easter Hester was born in Indiana { XE "Indiana: :Somers, Easter Hester (1823–1859)" \f "Place" } in 1823.^[222, 224] She was the daughter of Thomas Somers { XE "Somers:Thomas" \f "Name" \i }.
- Easter Hester reached 36 years of age and died in Illinois { XE "Illinois: :Somers, Easter Hester (1823–1859)" \f "Place" } on 5th March 1859.^[222, 224]
- f II. **Susie Sears** { XE "Sears:Susie (1816–1886)" \f "Name" \b } was born in Southeast { XE "USA, New York, Putnam, Southeast:(41.4054° N, 73.6001° W):Sears, Susie (1816–1886)" \f "Place" } in 1816. She died in 1886 at the age of 70.
- m III. **Heman Sears** { XE "Sears:Heman (1818–1893)" \f "Name" \b } was born in Ohio { XE "USA, Ohio:(40.2083° N, 81.325° W):Sears, Heman (1818–1893)" \f "Place" } on 10th

²²⁴ "Ancestry Family Tree", Record for Albert Hernando
Sears-<https://www.ancestry.com/family-tree/person/tree/51742382/person/13247539691/facts>.
<https://search.ancestry.com/cgi-bin/sse.dll?db=1030&h=250192109153&indiv=try>.

September 1818.^[225, 226, 227-228] He died in Burnside{ XE "USA, Illinois, Hancock, Burnside:(40.5039° N, 91.1° W):Sears, Heman (1818-1893)" \f "Place" } on 28th December 1893, at the age of 75.^[226] Heman was buried in Hancock{ XE "USA, Illinois, Hancock:(40.4021° N, 91.1689° W):Sears, Heman (1818-1893)" \f "Place" }.^[226]

More facts and events for Heman Sears:

Residence: 1870 Pilot Grove, Hancock{ XE "USA, Illinois, Hancock, Pilot Grove:(40.5028° N, 91.0794° W):Sears, Heman (1818-1893)" \f "Place" }.^[225, 228]
Residence Post Office: Fountain Green

Heman Sears was partnered with **Almira Lincoln**{ XE "Lincoln:Almira (1823-1896)" \f "Name" \b \i }.^[225, 226] They had six sons: George (1841-1911), Edward (1850-1910), Gilbert (1852-1940), Heman (ca.1855-), Orville (ca.1859-) and Frank (1867-1955).

Almira was born in Allegany, New York,{ XE "USA, New York, Allegany:(42.2549° N, 78.022° W):Lincoln, Almira (1823-1896)" \f "Place" } on Tuesday, 20th May 1823.^[225, 226] She reached 72 years of age and died in Burnside{ XE "USA, Illinois, Hancock, Burnside:(40.5039° N, 91.1° W):Lincoln, Almira (1823-1896)" \f "Place" } on 3rd March 1896.^[226] Almira was buried in Hancock{ XE "USA, Illinois, Hancock:(40.4021° N, 91.1689° W):Lincoln, Almira (1823-1896)" \f "Place" }.^[226]

- m IV. **Isaac Sears**{ XE "Sears:Isaac (1821-1823)" \f "Name" \b } was born in Southeast, Putnam, New York,{ XE "USA, New York, Putnam, Southeast:(41.4054° N, 73.6001° W):Sears, Isaac (1821-1823)" \f "Place" } in 1821. He died on 21st January 1823, at the age of 2. Isaac was buried in Milltown Cemetery, Southeast{ XE "USA, New York, Putnam, Southeast, Milltown Cemetery: :Sears, Isaac (1821-1823)" \f "Place" }.

Deborah Sears{ TC "Deborah Sears" \I 3 \f C }

- 117. Deborah⁴ Sears**{ XE "Sears:Deborah (1789-)" \f "Name" \b } (*Capt Thomas³, James²*) was born on Sunday, 18th October 1789, in Southeast, Putnam, New York, USA{ XE "USA, New York, Putnam, Southeast:(41.4054° N, 73.6001° W):Sears, Deborah (1789-)" \f "Place" }. She was the daughter of Thomas Sears{ XE "Sears:Thomas (1745-1804)" \f "Name" \i } (52) and Deborah Baldwin{ XE "Baldwin:Deborah (1749-1828)" \f "Name" \i } (53).

S P May p. 178

<https://www.wikitree.com/wiki/Sears-4777>

Marriages with (unknown given name) Ludington and (unknown given name) Craft (Page 148) are known.

²²⁵ Ancestry.com, 1870 United States Federal Census (Provo, UT, USA, Ancestry.com Operations, Inc., 2009), Ancestry.com, Year: 1870; Census Place: Pilot Grove, Hancock, Illinois; Roll: M593_227; Page: 242B; Family History Library Film: 545726.

²²⁶ Ancestry.com, U.S., Find A Grave Index, 1600s-Current (Provo, UT, USA, Ancestry.com Operations, Inc., 2012), Ancestry.com.

²²⁷ Dodd, Jordan, Liahona Research, comp, Illinois Marriages, 1790-1860 (Provo, UT, USA, Ancestry.com Operations Inc, 2004), Ancestry.com.

²²⁸ Ancestry.com, Selected U.S. Federal Census Non-Population Schedules, 1850-1880 (Provo, UT, USA, Ancestry.com Operations, Inc., 2010), Ancestry.com, Census Year: 1870; Census Place: Pilot Grove, Hancock, Illinois; Archive Collection Number: T1133; Roll: 17; Page: 1; Line: 35; Schedule Type: Agriculture.

Family of Deborah Sears and Ludington{ TC "Deborah Sears and Ludington" \I 4 \f C}

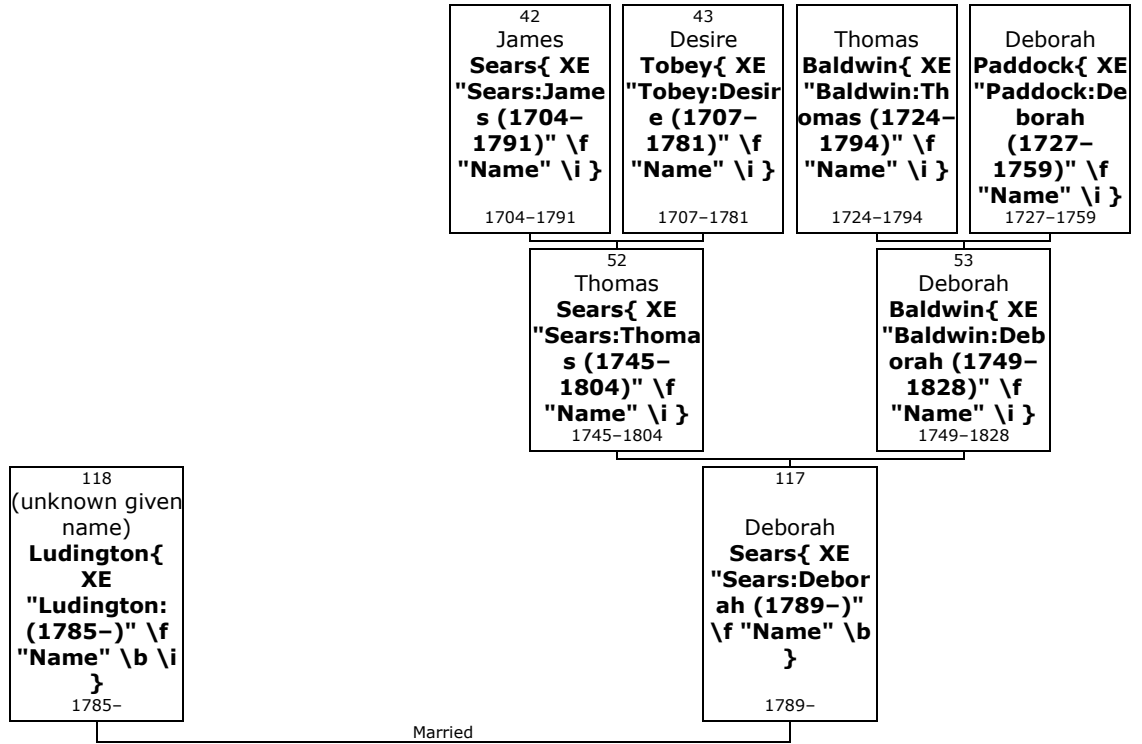

Here are the details about **Deborah Sears{ XE "Sears:Deborah (1789-)" \f "Name" \b }** first marriage, with (unknown given name) Ludington. You can read more about Deborah on page 146.

- 118.** Deborah Sears married **(unknown given name) Ludington{ XE "Ludington: (1785-)" \f "Name" \b \i }**. They had no known children.

(unknown given name) was born in perh, Southeast,{ XE "USA, New York, Putnam, Southeast, perh: Ludington, (1785-)" \f "Place" } in 1785.

Family of Deborah Sears and Craft{ TC "Deborah Sears and Craft" \I 4 \f C}

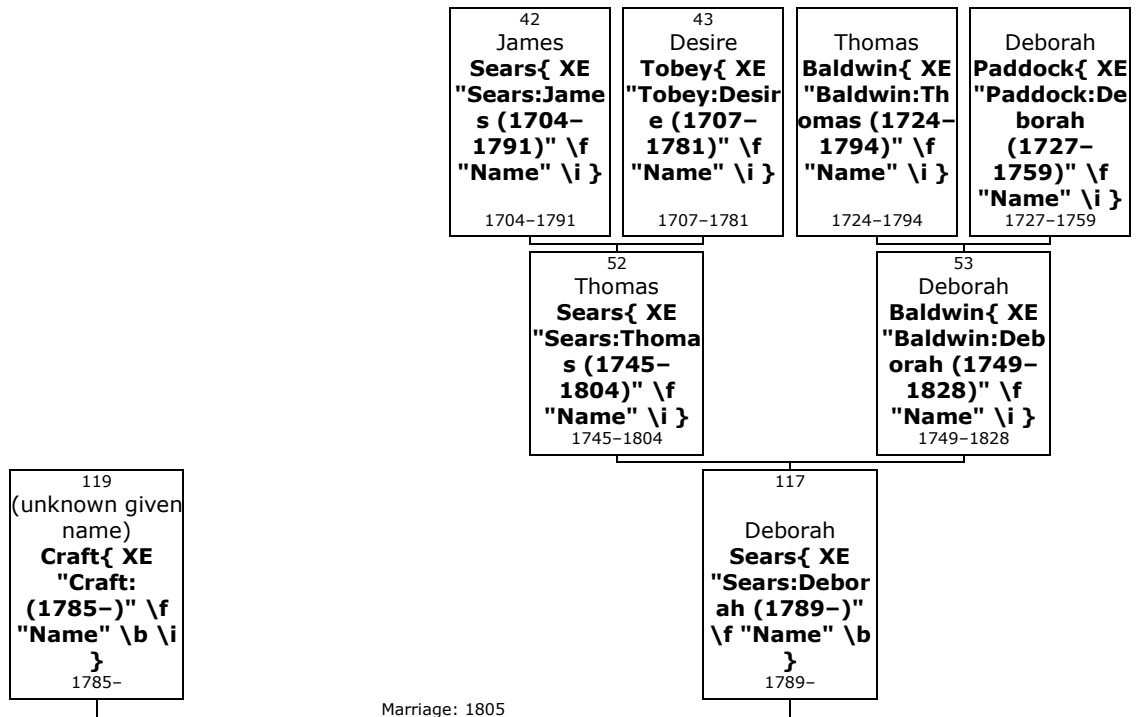

Here are the details about **Deborah Sears**{ XE "Sears:Deborah (1789-)" \f "Name" \b } second marriage, with (unknown given name) Craft. You can read more about Deborah on page 146.

- 119.** Deborah Sears married **(unknown given name) Craft**{ XE "Craft: (1785-)" \f "Name" \b \i } on Wednesday, 25th December 1805. They had no known children.

(unknown given name) was born in perh, Southeast,{ XE "USA, New York, Putnam, Southeast, perh: :Craft, (1785-)" \f "Place" } in 1785.

Family of Sally Sears and Ezra Young{ TC "Sally Sears and Ezra Young" \I 3 \f C}

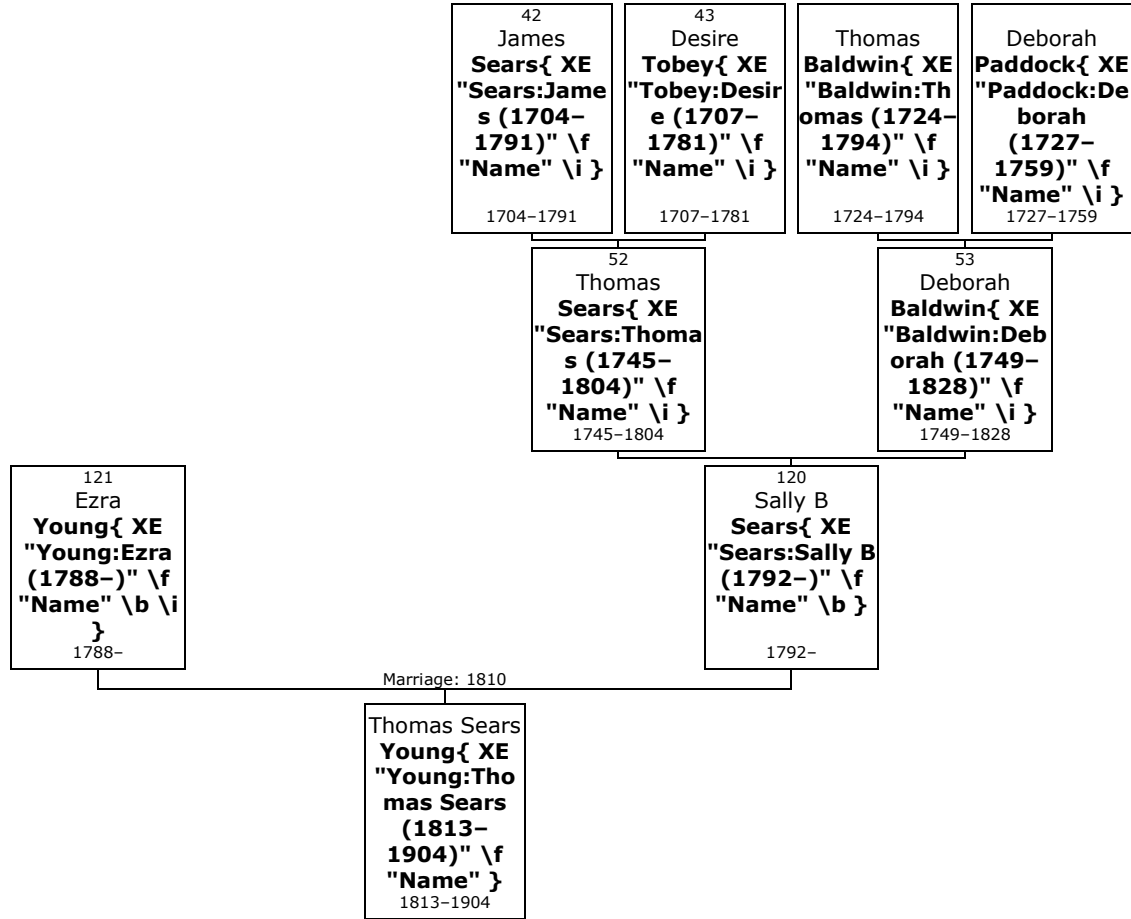

- 120.** **Sally B⁴ Sears**{ XE "Sears:Sally B (1792-)" \f "Name" \b } (*Capt Thomas³, James²*) was born on Tuesday, 26th June 1792, in Southeast, Putnam, New York, USA{ XE "USA, New York, Putnam, Southeast:(41.4054° N, 73.6001° W):Sears, Sally B (1792-)" \f "Place" }. She was the daughter of Thomas Sears{ XE "Sears:Thomas (1745-1804)" \f "Name" \i } (52) and Deborah Baldwin{ XE "Baldwin:Deborah (1749-1828)" \f "Name" \i } (53).

Phone conversation with Jane Mitchell, 9 The Byway, Bronxville, NY, 10708. She is descended from one of Sally's and Ezra's eleven children. She has many letters that Sally wrote to her children, some during the Civil War. Needs proof that Sally B (Sarah Baldwin) is dau of Thomas. She has gravestone but it doesn't show relationship.

<https://www.wikitree.com/wiki/Sears-4778>

- 121.** Sally B married **Ezra Young**{ XE "Young:Ezra (1788-)" \f "Name" \b \i } on Tuesday, 27th March 1810. They had one son: Thomas (1813-1904).

Ezra was born in perh, Southeast,{ XE "USA, New York, Putnam, Southeast, perh: :Young, Ezra (1788-)" \f "Place" } in 1788.

Son of Sally B Sears and Ezra Young:

- m I. **Thomas Sears⁵ Young**{ XE "Young:Thomas Sears (1813-1904)" \f "Name" \b } was born in New York{ XE "USA, New York:(42.7531° N, 74.2224° W):Young, Thomas Sears

(1813–1904)" \f "Place" } in 1813.^[229] He died on 3rd April 1904, at the age of 91. Thomas Sears was buried in Milltown Cemetery, Southeast, Putnam{ XE "USA, New York, Putnam, Southeast, Milltown Cemetery: :Young, Thomas Sears (1813–1904)" \f "Place" }.

More facts and events for Thomas Sears Young:

Residence: 1855 Manhattan, New York{ XE "USA, New York, New York, Manhattan:(40.7834° N, 73.9663° W):Young, Thomas Sears (1813–1904)" \f "Place" }^[229]
Age: 42; RelationToHead: Head/Ward 18

At the age of 21, Thomas Sears married **Mary E Sears**{ XE "Sears:Mary E (1814–1860)" \f "Name" \b \i } on Wednesday, 15th October 1834, when she was 20 years old.^[229, 230] They had six children: Martha (1838–1883), Mary (1840–), Thomas (1842–), Edward (1846–), Emma (1853–) and David (1855–).

Mary E was born in Southeast, Putnam,{ XE "USA, New York, Putnam, Southeast:(41.4054° N, 73.6001° W):Sears, Mary E (1814–1860)" \f "Place" } on Thursday, 26th May 1814.^[229, 230] She was the daughter of Isaac Sears{ XE "Sears:Isaac (1772–1839)" \f "Name" \i } and Priscilla Bennett{ XE "Bennett:Priscilla (1774–1851)" \f "Name" \i }.

Mary E reached 45 years of age and died on 3rd February 1860.^[230] She was buried in Milltown Cemetery, Southeast, Putnam{ XE "USA, New York, Putnam, Southeast, Milltown Cemetery: :Sears, Mary E (1814–1860)" \f "Place" }.

!S P May No 1022 Gemini

<https://www.wikitree.com/wiki/Sears-5537>

²²⁹ Ancestry.com, New York, State Census, 1855 (Provo, UT, USA, Ancestry.com Operations, Inc., 2013), Ancestry.com, Record for Thomas Young. <http://search.ancestry.com/cgi-bin/sse.dll?db=7181&h=1655538174&indiv=try>.

²³⁰ "Ancestry Family Tree", Record for Isaac Sears. <https://familysearch.org/ark:/61903/1:1:F74T-WDC>.

Family of Huldah Sears and Isaac Brownson{ TC "Huldah Sears and Isaac Brownson" \I 3 \f C}

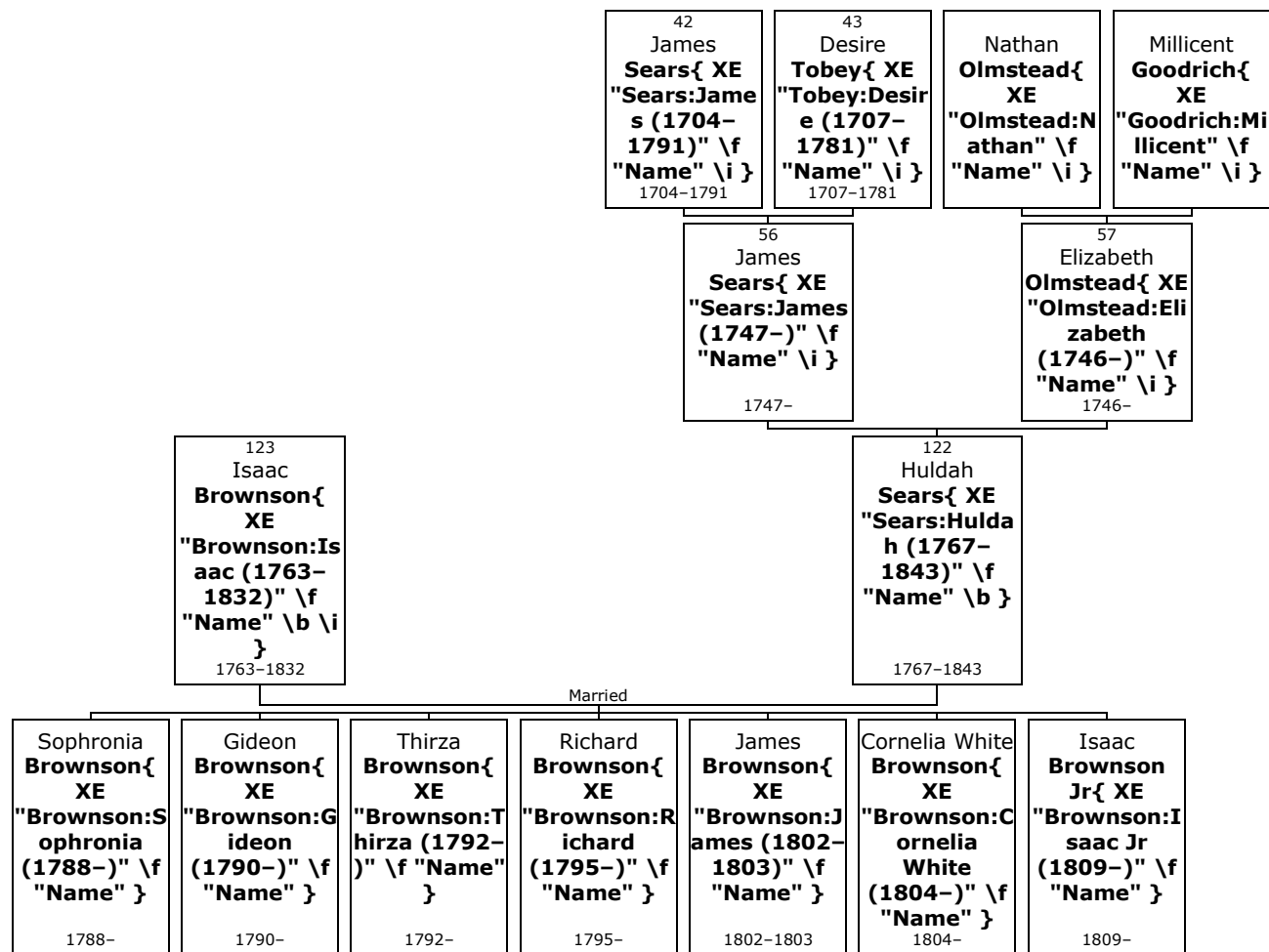

- 122.** **Huldah⁴ Sears**{ XE "Sears:Huldah (1767-1843)" \f "Name" \b } (*James³, James²*) was born on Friday, 9th October 1767. She was the daughter of James Sears{ XE "Sears:James (1747-)" \f "Name" \i } (56) and Elizabeth Olmstead{ XE "Olmstead:Elizabeth (1746-)" \f "Name" \i } (57).

Huldah died in 1843 at the age of 75.

DSB-Entry in Sunderland town records by Isaac Brownson, and also Rev. War Pension records for Isaac Brownson. Children come from Brownson Bible- copies of pages included in pension records. S P May No 780

- 123.** She married **Isaac Brownson**{ XE "Brownson:Isaac (1763-1832)" \f "Name" \b \i }. They had seven children: Sophronia (1788-), Gideon (1790-), Thirza (1792-), Richard (1795-), James (1802-1803), Cornelia (1804-) and Isaac (1809-).

Isaac was born in Sunderland, Bennington, Vermont, USA,{ XE "USA, Vermont, Bennington, Sunderland:(43.1133° N, 73.1036° W):Brownson, Isaac (1763-1832)" \f "Place" } in 1763. He reached 69 years of age and died in Gainesville, Wyoming, New York,{ XE "USA, New York, Wyoming, Gainesville:(42.6409° N, 78.1339° W):Brownson, Isaac (1763-1832)" \f "Place" } on 18th July 1832.

!DSB-Married by Gideon Brownson, Isaac was a widower with a 1 yr old daughter, Elizabeth. Isaac and Huldah moved to Gainesville, Genessee (now Wyoming co), NY by 1818, and lived the remainder of their lives there. He was a musician in his father's company (Col Seth Warner's Regt, of Continental Troops)

Children of Huldah Sears and Isaac Brownson:

- f I. **Sophronia⁵ Brownson**{ XE "Brownson:Sophronia (1788-)" \f "Name" \b } was born in Sunderland, Bennington, Vermont,{ XE "USA, Vermont, Bennington, Sunderland:(43.1133° N, 73.1036° W):Brownson, Sophronia (1788-)" \f "Place" } on 11th August 1788.

- m II. **Gideon Brownson**{ XE "Brownson:Gideon (1790-)" \f "Name" \b } was born in perh, Sunderland,{ XE "USA, Vermont, Bennington, Sunderland, perh: :Brownson, Gideon (1790-)" \f "Place" } on 24th March 1790.
- f III. **Thirza Brownson**{ XE "Brownson:Thirza (1792-)" \f "Name" \b } was born in perh{ XE "USA, Vermont, Bennington, Sunderland, perh: :Brownson, Thirza (1792-)" \f "Place" } on 11th August 1792.
- m IV. **Richard Brownson**{ XE "Brownson:Richard (1795-)" \f "Name" \b } was born in perh{ XE "USA, Vermont, Bennington, Sunderland, perh: :Brownson, Richard (1795-)" \f "Place" } on 8th September 1795.
- m V. **James Brownson**{ XE "Brownson:James (1802-1803)" \f "Name" \b } was born in perh{ XE "USA, Vermont, Bennington, Sunderland, perh: :Brownson, James (1802-1803)" \f "Place" } on 19th November 1802. He died on 25th December 1803, at the age of 1.
- f VI. **Cornelia White Brownson**{ XE "Brownson:Cornelia White (1804-)" \f "Name" \b } was born in perh{ XE "USA, Vermont, Bennington, Sunderland, perh: :Brownson, Cornelia White (1804-)" \f "Place" } on 4th November 1804.
- m VII. **Isaac Brownson Jr**{ XE "Brownson:Isaac Jr (1809-)" \f "Name" \b } was born in perh{ XE "USA, Vermont, Bennington, Sunderland, perh: :Brownson, Isaac Jr (1809-)" \f "Place" } on 12th July 1809.

Family of Nathan Sears and Sybil --Sears{ TC "Nathan Sears and Sybil --Sears" \I 3 \f C}

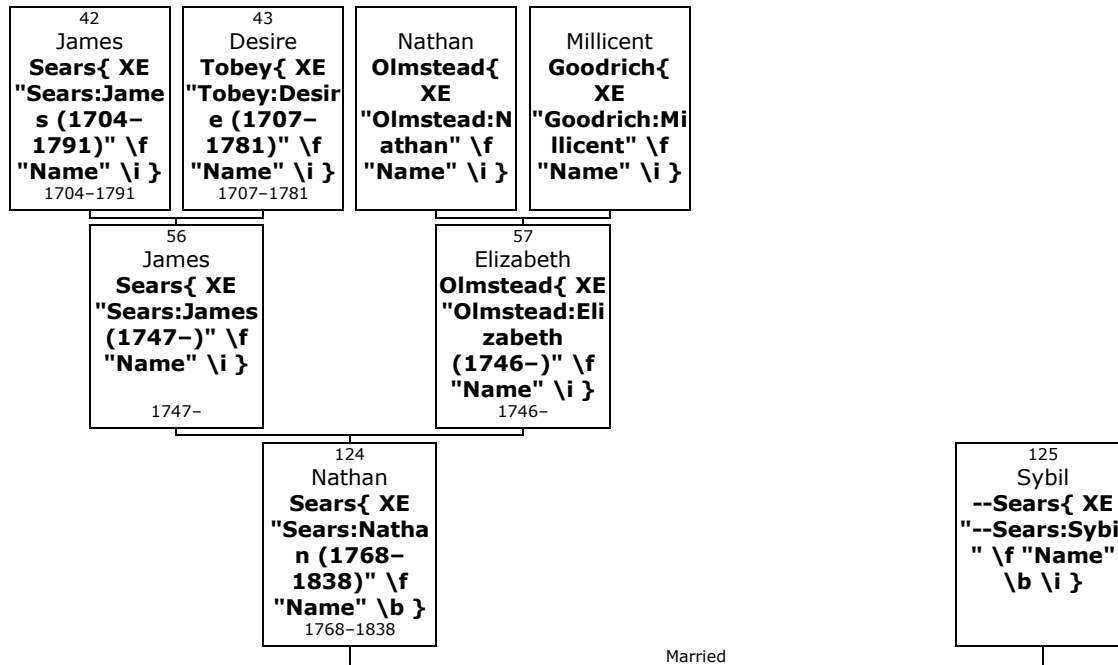

124. Nathan⁴ Sears{ XE "Sears:Nathan (1768-1838)" \f "Name" \b } (*James³, James²*) was born on Monday, 22nd August 1768. He was the son of James Sears{ XE "Sears:James (1747-)" \f "Name" \i } (56) and Elizabeth Olmstead{ XE "Olmstead:Elizabeth (1746-)" \f "Name" \i } (57).

Nathan died in Shefford, La Haute-Yamaska, Quebec, Canada,{ XE "Canada, Quebec, La Haute-Yamaska, Shefford:(45.4167° N, 72.5833° W):Sears, Nathan (1768-1838)" \f "Place" } on 15th November 1838, at the age of 70.

!DSB-I believe the Nathan Sears, whose birth is recorded in Alburgh Town Records (but not born in Alburgh) is this Nathan. Wesleyan Meth. Church records of Shefford, Quebec, contain a record of his death "On 15th day of Nov 1838 died Nathan Sears, farmer of the Twsp of Shefford in the Co. of Shefford and Dist.of Montreal, being in the 70th year of his age__" He applied for land in Quebec along with James and hezekiah, in Arlington, VT, in 1787. Nathan did receive Caldwell Manor land and moved to Quebec about 1789. He applied for Sutton land in 1795, was granted it-sold the last of Sutton land in 1806, and moved to Alburgh 1806 or earlier. Had children James and Eliza (prob many more).Was enum in Alburgh census in 1810. Must have moved to Shefford bewteen 1810 and 1820.

125. He married **Sybil --Sears**{ XE "--Sears:Sybil" \f "Name" \b \i }.

Family of Hezekiah Sears and Roxana --Sears{ TC "Hezekiah Sears and Roxana --Sears" \I 3 \f C}

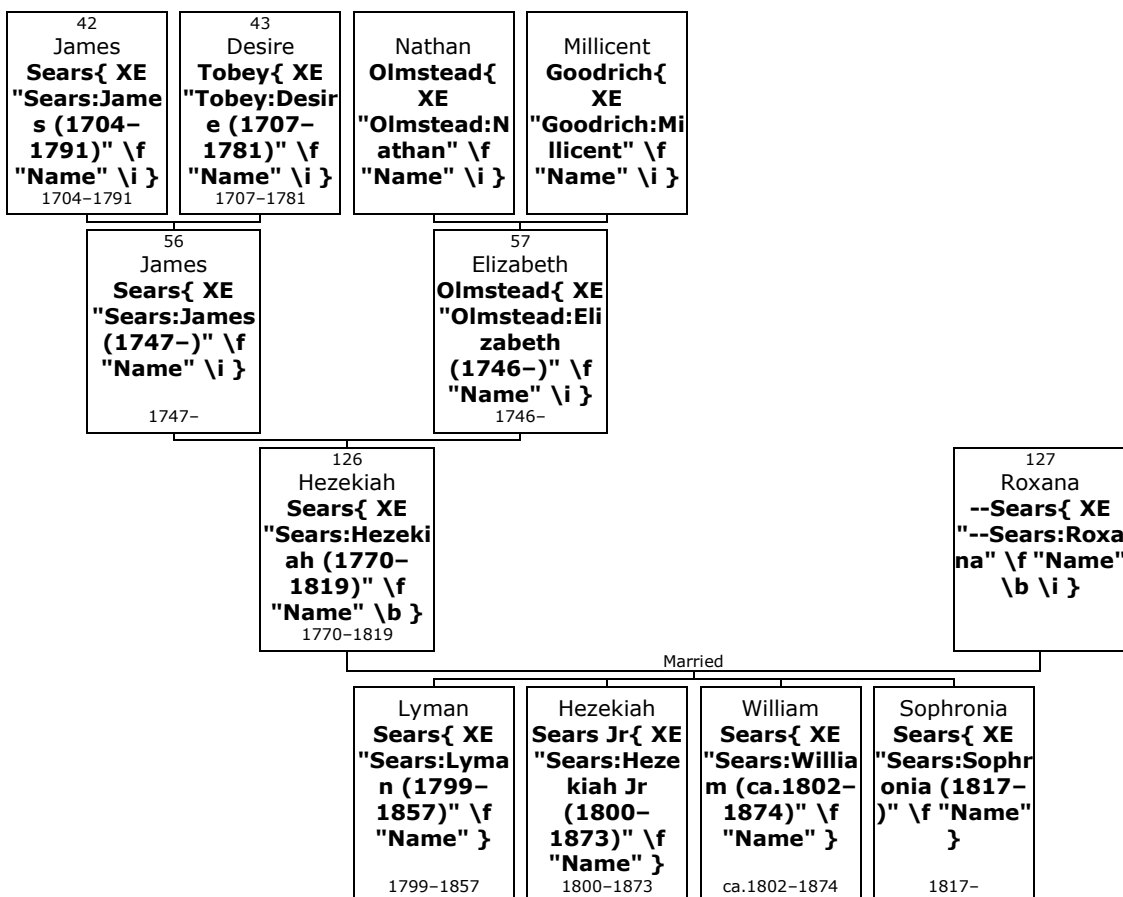

126. **Hezekiah⁴ Sears**{ XE "Sears:Hezekiah (1770-1819)" \f "Name" \b } (*James³, James²*) was born in 1770 in Massachusetts, USA{ XE "USA, Massachusetts:(42.1562° N, 71.5662° W):Sears, Hezekiah (1770-1819)" \f "Place" }. He was the son of James Sears{ XE "Sears:James (1747-)" \f "Name" \i } (56) and Elizabeth Olmstead{ XE "Olmstead:Elizabeth (1746-)" \f "Name" \i } (57).

Hezekiah died in Caldwell Manor, Quebec, Canada,{ XE "Canada, Quebec, Caldwell Manor: :Sears, Hezekiah (1770-1819)" \f "Place" } in 1819 at the age of 49.

!S P May No 775 possib b. CT

<https://www.wikitree.com/wiki/Sears-869>

!

!DSB-Applied for land in Quebec at Arlington, VT, in 1786/7. Was deeded 100 acres in lot 9, 9th Con of Caldwell Manor, Quebec on 9 Oct 1789. Applied for Sutton land in 1795, and granted land at Sutton in 1802, but sold it in 1802. Regulations did not require that he live on this Sutton land, and I doubt Hezekiah ever lived anywhere but Caldwell Manor. Rules in original contract required grantees to have someone live on, and work, land for 7 years. Since many of these grantees sold their land in 1802, I believe they actually took up possession of the land in 1705, and after their 7 years were up (1802), they were actually owners of it. Hezekiah lived at Caldwell Manor when he sold the Sutton land, and when he died. Hezekiah was the father of at least 3 children-proven on deeds. The deed when the younger Hezekiah sold his inherited land in 1834 stated-"as the same was by him inherited by right of Succession to Hezekiah Sears, late of said Foucault, deceased, his father."

<https://blog.searsr.com/2020/01/26/barns-in-missisquoi-county/>

127. He married **Roxana --Sears**{ XE "--Sears:Roxana" \f "Name" \b \i }. They had four children: Lyman (1799-1857), Hezekiah (1800-1873), William (ca.1802-1874) and Sophronia (1817-).

Children of Hezekiah Sears and Roxana --Sears:

- m I. **Lyman⁵ Sears**{ XE "Sears:Lyman (1799–1857)" \f "Name" \b } was born in Caldwell Manor{ XE "Canada, Quebec, Caldwell Manor: :Sears, Lyman (1799–1857)" \f "Place" } in 1799. He died in Missisquoi Co{ XE "Canada, Quebec, Missisquoi Co: :Sears, Lyman (1799–1857)" \f "Place" } between 1857 and 1861.
- Lyman married **Fanny Nutt**{ XE "Nutt:Fanny (1805–1861)" \f "Name" \b \i }. They had three children: John (1823–1897), Miriam (1828–) and Lucinda (1830–).
- Fanny was born in Quebec{ XE "Canada, Quebec:(47.4278° N, 71.8805° W):Nutt, Fanny (1805–1861)" \f "Place" } in 1805. She reached 56 years of age and died in 1861.
- !BIRTH-DEATH: Letter from Diane Sears Brigode, Northglenn, CO, to Ray Sears in Duncan, OK; 1830-1915; Letter dtd 27 Jan 1994; ; copy in poss of Ray Sears; Family Group Sheets.
- m II. **Hezekiah Sears Jr**{ XE "Sears:Hezekiah Jr (1800–1873)" \f "Name" \b } was born in Caldwell Manor{ XE "Canada, Quebec, Caldwell Manor: :Sears, Hezekiah Jr (1800–1873)" \f "Place" } on 28th February 1800. He died in Loughborough, Frontenac, Ontario,{ XE "Canada, Ontario, Frontenac, Loughborough: :Sears, Hezekiah Jr (1800–1873)" \f "Place" } on 7th April 1873, at the age of 73. Hezekiah was buried at Latimer Cemetery in Frontenac{ XE "Canada, Ontario, Frontenac:(44.6668° N, 76.7494° W):Sears, Hezekiah Jr (1800–1873)" \f "Place" }.
- Hezekiah Sears Jr married **Lavina Van Valkinburgh**{ XE "Van Valkinburgh:Lavina (1805–1880)" \f "Name" \b \i } in prob, Caldwell Manor, Quebec{ XE "Canada, Quebec, Caldwell Manor, prob: :Sears, Hezekiah Jr (1800–1873)" \f "Place" }. They had five children: Catherine (1825–1895), Horace (1828–1894), David (1833–1888), William (1840–1887) and John (1845–1921).
- Lavina was born in Quebec{ XE "Canada, Quebec:(47.4278° N, 71.8805° W):Van Valkinburgh, Lavina (1805–1880)" \f "Place" } in 1805. She was also known as **Lavina Von Volkingburgh**{ XE "Volkingburgh:Lavina (Lavina Van Valkinburgh) (1805–1880)" \f "Name" }.
- Lavina reached 75 years of age and died in Bedford Township, Frontenac, Ontario,{ XE "Canada, Ontario, Frontenac, Bedford Township: :Van Valkinburgh, Lavina (1805–1880)" \f "Place" } in 1880.
- also Vanvolkingburgh 1. Records Author: Sears-Degrugillier, Sheila Publication: Fargo, ND, USA
- m III. **William Sears**{ XE "Sears:William (ca.1802–1874)" \f "Name" \b } was born at Gord Ballik: Canada East Diane Brigode:07 Apr 1802, Caldwell Manor, Quebec, Canada in Noyan, Le Haut-Richelieu,{ XE "Canada, Quebec, Le Haut-Richelieu, Noyan:(45.0657° N, 73.299° W):Sears, William (ca.1802–1874)" \f "Place" } about 1802. He died at d.- Gord Ballik in Frontenac, Ontario,{ XE "Canada, Ontario, Frontenac:(44.6668° N, 76.7494° W):Sears, William (ca.1802–1874)" \f "Place" } on 27th April 1874, at the age of 72.
- At the age of 23, William Sears married **Margaret Nutt**{ XE "Nutt:Margaret (1804–1883)" \f "Name" \b \i } on Sunday, 16th October 1825, at source: Gord Ballik in Clarenceville, Missisquoi, Quebec,{ XE "Canada, Quebec, Missisquoi, Clarenceville: :Sears, William (ca.1802–1874)" \f "Place" } when she was 21 years old. They had eight children: Betsy (1826–1842), William (1828–1909), Jane (1833–1882), Abigail (ca.1835–1888), Samuel (1838–1922), John (1840–1928), Miriam (1845–<1870) and Alma (1856–).
- Margaret was born in Missisquoi Co{ XE "Canada, Quebec, Missisquoi Co: :Nutt, Margaret (1804–1883)" \f "Place" } on Monday, 23rd January 1804. She was the daughter of David Nutt{ XE "Nutt:David (1779–1845)" \f "Name" \i } and Elizabeth Mitchell{ XE "Mitchell:Elizabeth (1777–1842)" \f "Name" \i }.
- Margaret reached 79 years of age and died at source:Gord Ballik in Frontenac, Ontario,{ XE "Canada, Ontario, Frontenac:(44.6668° N, 76.7494° W):Nutt, Margaret (1804–1883)" \f "Place" } on 25th May 1883.
- f IV. **Sophonra Sears**{ XE "Sears:Sophonra (1817–)" \f "Name" \b } was born in Quebec{ XE "Canada, Quebec:(47.4278° N, 71.8805° W):Sears, Sophronia (1817–)" \f "Place" } in 1817.

Sophronia married **John Fairchild**{ XE "Fairchild:John" \f "Name" \b \i }.

Family of Thirza Sears and Ephraim Hawley{ TC "Thirza Sears and Ephraim Hawley" \I 3 \f C}

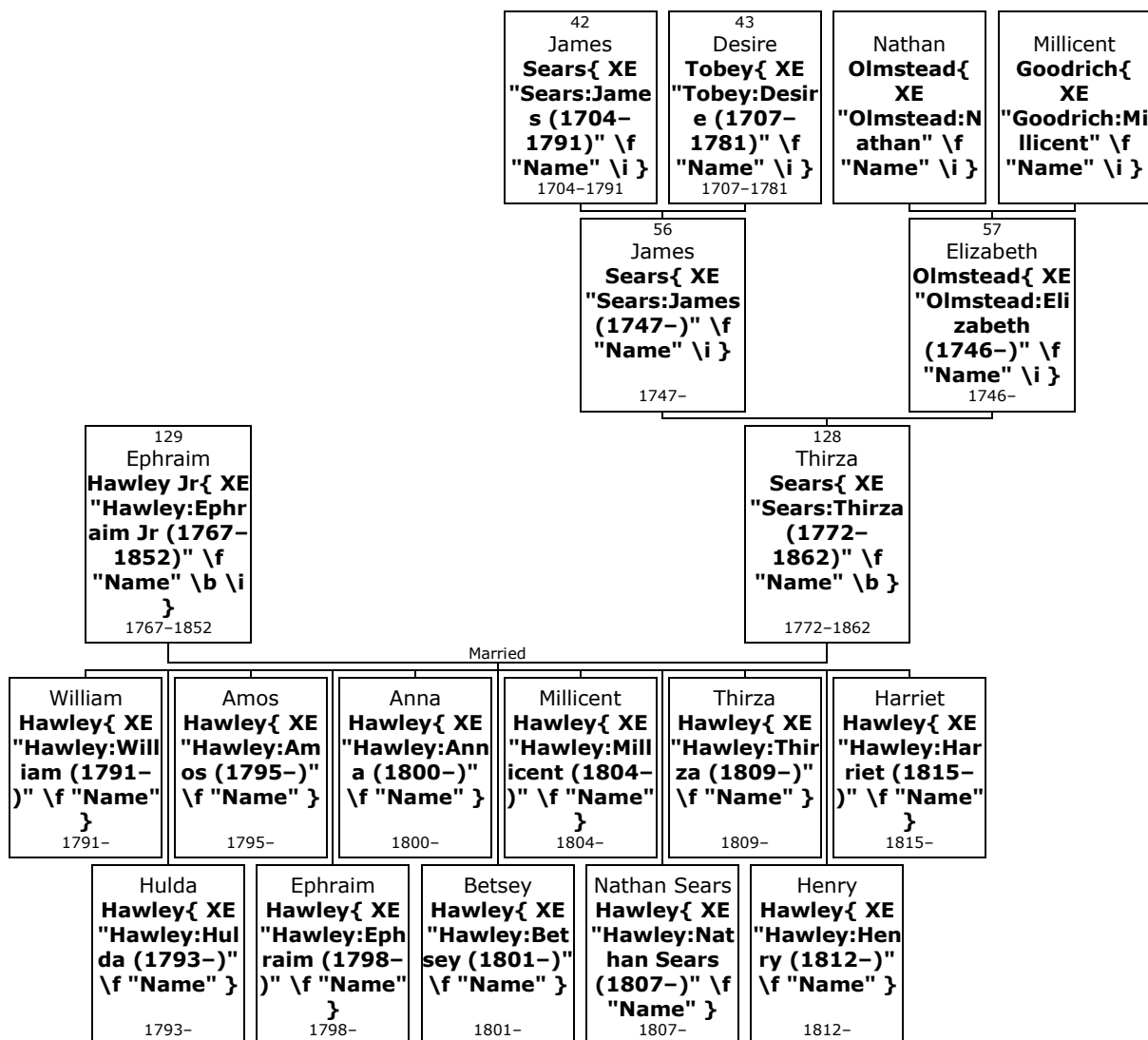

- 128.** **Thirza⁴ Sears**{ XE "Sears:Thirza (1772-1862)" \f "Name" \b \i } (*James³, James²*) was born in 1772. She was the daughter of James Sears{ XE "Sears:James (1747-)" \f "Name" \i } (56) and Elizabeth Olmstead{ XE "Olmstead:Elizabeth (1746-)" \f "Name" \i } (57).

Thirza died on 12th April 1862, at the age of 90.

!DSB-Moved to Sutton in 1799. Hawley family records state she was the dau. of James Sears and Elizabeth Olmsted.

- 129.** She married **Ephraim Hawley Jr**{ XE "Hawley:Ephraim Jr (1767-1852)" \f "Name" \b \i }. They had eleven children: William (1791-), Hulda (1793-), Amos (1795-), Ephraim (1798-), Anna (1800-), Betsey (1801-), Millicent (1804-), Nathan (1807-), Thirza (1809-), Henry (1812-) and Harriet (1815-).

Ephraim was born on Tuesday, 13th January 1767. He reached 85 years of age and died on 24th August 1852.

Children of Thirza Sears and Ephraim Hawley Jr:

- m I. **William⁵ Hawley**{ XE "Hawley:William (1791-)" \f "Name" \b \i } was born in 1791.
- f II. **Hulda Hawley**{ XE "Hawley:Hulda (1793-)" \f "Name" \b \i } was born in 1793.
- m III. **Amos Hawley**{ XE "Hawley:Amos (1795-)" \f "Name" \b \i } was born in 1795.
- m IV. **Ephraim Hawley**{ XE "Hawley:Ephraim (1798-)" \f "Name" \b \i } was born in 1798.

- f V. **Anna Hawley**{ XE "Hawley:Anna (1800-)" \f "Name" \b } was born in 1800.
- f VI. **Betsey Hawley**{ XE "Hawley:Betsey (1801-)" \f "Name" \b } was born in 1801.
- f VII. **Millicent Hawley**{ XE "Hawley:Millicent (1804-)" \f "Name" \b } was born in 1804.
- m VIII. **Nathan Sears Hawley**{ XE "Hawley:Nathan Sears (1807-)" \f "Name" \b } was born in 1807.
- f IX. **Thirza Hawley**{ XE "Hawley:Thirza (1809-)" \f "Name" \b } was born in 1809.
- m X. **Henry Hawley**{ XE "Hawley:Henry (1812-)" \f "Name" \b } was born in 1812.
- f XI. **Harriet Hawley**{ XE "Hawley:Harriet (1815-)" \f "Name" \b } was born in 1815.

Family of Lyman Sears and Hannah Sager{ TC "Lyman Sears and Hannah Sager" \I 3 \f C}

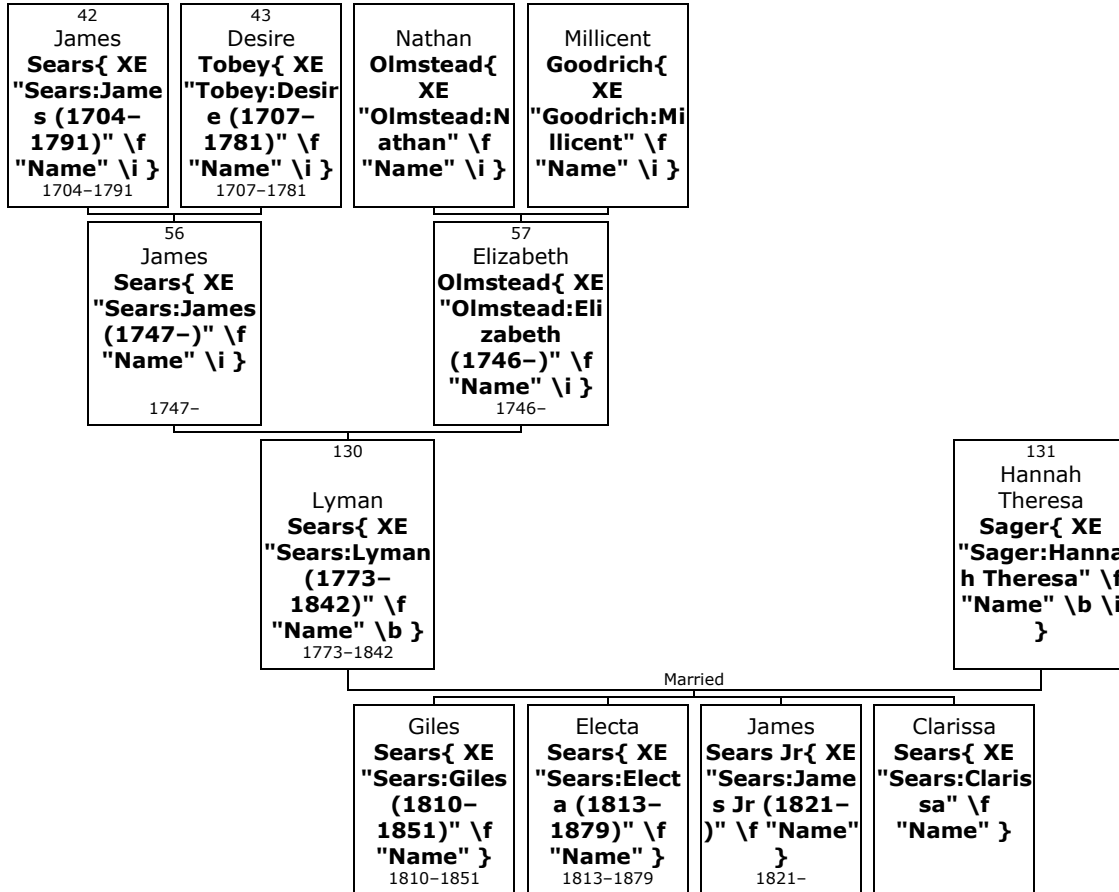

130. Lyman⁴ Sears{ XE "Sears:Lyman (1773-1842)" \f "Name" \b } (*James³, James²*) was born between 1773 and 1778. He was the son of James Sears{ XE "Sears:James (1747-)" \f "Name" \i } (56) and Elizabeth Olmstead{ XE "Olmstead:Elizabeth (1746-)" \f "Name" \i } (57).

Lyman died in 1842.

!S P May No 777

<https://www.wikitree.com/wiki/Sears-871>

!

!DSB-Vivian West Broberg has written a book (Always Westward) which contains info on descendants of Lyman's one known daughter, Electa (b) 1813. Lyman had at least 9 children.

From: Diane Brigode <dakotah58@yahoo.com>

Date: Sun, Jan 26, 2020 at 9:54 AM

Subject: Re: Photos from our 2002 trip to Quebec

To: Andrew Sears <andrewjsears@gmail.com>

Yes - I see no reason you can't put that on the Sears site. I saw one thing I had wrong on the below email, but didn't know that you were going to put it online, so I didn't figure it was a big deal. So could you delete the 2 words "and Ontario" right after took a trip up into Quebec? My husband and I went to Ontario after Quebec, but my cousin and her husband did not go with us to Ontario.

I just looked at the searsr.com site. There is one thing that I want to call to your attention that is clearly wrong. Is it possible to change it?

See the church record below? Ray has this James Sears as son of James Sears Jr. - son of James and Elizabeth. Here is his death record:

South Stukely Methodist Church, 1890

On the back of folio 5

Quebec National Archives microfilm #347.10

Sent by Marlene Simmons

James Sears, son of Lyman and Hannah Sears, was born on the 9th day of April, 1820, died on the 10th day of August 1890, and was buried by me on the 12th day of August in the same year in the presence of subscribing witnesses

(signed) Henry A. Young (Minister)

Chattie? E. Sears

William F. Sears

This would mean that William Giles and Clarissa were also children of Lyman, and not James Jr. But that can come later. I know where Ray got that informatioin. Years ago there was a man named Richard Elwin Sears, who lived in Tunbridge, VT. He was a descendant of Giles. Died many years ago. We corresponded. He visited my North Dakota relatives!

This Sears branch is so difficult when it comes to children of Lyman Sears, who married Hannah Theresa Sager - and those of his brother James Sears Jr. I will be writing up something on this for you - hopefully I can start today..

In the meantime - it appears the above pretty well shows that this James Sears was the son of Lyman and Hannah - and not of James Sears Jr. and his unknown wife?

Another great difficulty is the ancestry of James Sears, who married Elinor Wilson, and that of Alexander Sears. I've tried for years to figure out who they were!

Diane

Diane Brigode

Attachments

8:34 AM (5 hours ago) 3 Feb 2020

to Andrew, me

Thanks for correcting this!

The family of James Sears and Elizabeth Olmsted is one I've worked on for over 30 years, and even though I've proved much on it, several things are still in the works:

1)Vivian Broberg - in her genealogy that she shared with me - indicated James and Elizabeth had a son David. I did not add him for years - because I had found nothing else that would point to this. But several years ago, I came across some notarial docs that mentioned a David Sears from Sutton, Quebec. This David, as the probable youngest child of James and Elizabeth, likely wouldn't have been included in the land petitions. I have a clue as to where he might have ended up, but nothing proven yet.

2)James Sears Jr. - His wife is so far unknown. Tim Cole has been working on this using DNA, but nothing has come up so far. I have 7 likely children for him - Mahala, Charles G., Chauncey, Daniel, Benjamin, Harlow, and a "Goodrey C (Guttridge)". I have not shared this, because I didn't want to put more false information on the web, in case I am wrong. Charles G. WAS a son. Commenting generally, none of the ones mentioned above stayed in Quebec, or they died young. Following them into Ontario or the states, I have not proven any of these so far.

3) Lyman Sears - Married Hannah Theresa Sager, daughter of Michael. I have 8 likely children for them: Clarissa (1801), "Alma" Hannah Barbara (1802), Thirza (@1804), Sarah (1807), William Giles (Abt. 1810), Electa (Abt 1813), Julia Izzetta (1820), James (1820). Second marriage to Susannah Corliss. How I picked them

is quite involved for some. Electa and James are proven. Richard E. Sears (descendant of William Giles) wrote this to me and it pretty much cements the connection - as much as possible anyway:

From a letter written by Richard E. Sears in March, 1991: "At Lillian Sears Proper's funeral in 1966, a lady named Evelyn McClary Wilson introduced herself as a relative, and later wrote me a letter confirming her grandmother (Aunt Tib) as a daughter of James Sears Jr. and Charlotte Davis. Aunt Tib was Elizabeth Sears. Evelyn McClary Wilson also mentioned that Aunt Tib was first cousin to my great grandfather Alden Sears and Lillian's father William Sears - sons of Giles and Sarah Tallman Sears."

I am in the process of writing up an article on my searches for this, and will send it when I am done. I know that both of you are busy with the site these days, and it appears it is going well. But keeping you busy, I am sure.

Please use my dakotah58@yahoo.com email. The ecentral one has issues, and my limited computer ability is preventing me from using it much at all.

I am attaching a family group record on Nathan Sears, wife, and children - and 1 other.

Again - Thanks.

Diane Sears Brigode

Leslie Ray Sears, III <ltlrsears@gmail.com>
2:21 PM (10 minutes ago) 3 Feb 2020
to Diane

Wow Diane- you are a wizard in ferreting out info on these branches of the tree. Thanks so much. Have you thought about having your article published? I am the editor of The Journal of the Cape Cod Genealogical Society and we are always looking for new material.

We would send you a copy of the Journal- it is usually 150 pages, goes out to 350 subscribers and is published in Feb and Oct of each year.

Thanks again,
Ray

Sent from my iPhone

Begin forwarded message:

From: "Leslie Ray Sears, III" <ltlrsears@gmail.com>
Date: February 2, 2020 at 2:36:10 PM MST
To: Diane Brigode <brigode@ecentral.com>, Andrew Sears <andrewjsears@gmail.com>
Subject: Correcting Children of James Sears, Jr

131. He married **Hannah Theresa Sager**{ XE "Sager:Hannah Theresa" \f "Name" \b \i }. They had four children: Giles (1810-1851), Electa (1813-1879), James (1821-) and Clarissa.

Children of Lyman Sears and Hannah Theresa Sager:

m I. **Giles⁵ Sears**{ XE "Sears:Giles (1810-1851)" \f "Name" \b } was born in Sutton, Brome-Missisquoi, Quebec, Canada,{ XE "Canada, Quebec, Brome-Missisquoi,

Sutton:(45.1° N, 72.6167° W):Sears, Giles (1810–1851)" \f "Place" } in 1810.^[231, 232-233] He died in Sutton{ XE "Canada, Quebec, Brome-Missisquoi, Sutton:(45.1° N, 72.6167° W):Sears, Giles (1810–1851)" \f "Place" } on 12th March 1851, at the age of 41.^[231, 232] Giles was buried in Sweet Cemetery, Draper Hill, Sutton{ XE "Canada, Quebec, Brome-Missisquoi, Sutton, Draper Hill, Sweet Cemetery: :Sears, Giles (1810–1851)" \f "Place" }.^[231, 232]

Giles married **Sarah Tallman**{ XE "Tallman:Sarah (1809–1876)" \f "Name" \b \i } on Wednesday, 14th December 1831, in Berkshire, Franklin, Vermont, USA{ XE "USA, Vermont, Franklin, Berkshire:(44.9717° N, 72.7758° W):Sears, Giles (1810–1851)" \f "Place" }.^[232, 233] They had seven children: David (1833–1863), Edwin (1837–1863), Alden (1841–1892), Emily (1842–1845), William (1845–1913), Emily (1848–1874) and Giles (-1860).

Sarah was born in New York{ XE "USA, New York:(42.7531° N, 74.2224° W):Tallman, Sarah (1809–1876)" \f "Place" } in 1809.^[232] She reached 67 years of age and died on 24th July 1876.^[232] Sarah was buried.^[232] Sweet Cem, Draper Hill, Sutton.

- f II. **Electa Sears**{ XE "Sears:Electa (1813–1879)" \f "Name" \b } was born on 26th July 1813. She was christened in 1845. Electa died at 65y 7m 2d in Jay, Orleans, Vermont, USA,{ XE "USA, Vermont, Orleans, Jay:(44.9475° N, 72.4375° W):Sears, Electa (1813–1879)" \f "Place" } on 28th February 1879, at the age of 65. She was buried in Methodist Cemetery, Farnham, Brome-Missisquoi, Quebec, Canada{ XE "Canada, Quebec, Brome-Missisquoi, Farnham, Methodist Cemetery: :Sears, Electa (1813–1879)" \f "Place" }.

Electa Sears married **Erastus Robert West**{ XE "West:Erastus Robert (1804–1884)" \f "Name" \b \i }. They had one son: Lyman (1846–).

Erastus Robert was born in Alburg, Grand Isle, Vermont, USA,{ XE "USA, Vermont, Grand Isle, Alburg:(44.975° N, 73.3002° W):West, Erastus Robert (1804–1884)" \f "Place" } on Tuesday, 7th August 1804. He was the son of Peter West{ XE "West:Peter" \f "Name" \i } and Prudence --West{ XE "--West:Prudence" \f "Name" \i }.

Erastus Robert reached 79 years of age and died at 79y 7m 12d in Jay, Orleans,{ XE "USA, Vermont, Orleans, Jay:(44.9475° N, 72.4375° W):West, Erastus Robert (1804–1884)" \f "Place" } on 19th March 1884.

Always Westward by Vivan West Broberg, Fine Print Inc, 1984, Fargo, ND d ae 79,7,12 = born 7 Aug 1804

Erastus Robert West, father of Lyman Sears West, and the second son of Peter West and Prudence Niles, was born in Alburgh, Vermont in 1804. He died 19 Mar 1884 at Jay, Vermont. His wife Electa Sears West, died ...It was said that Erastus was an itinerant Methodist minister. Of this we cannot be certain, but it is a fact that he moved a great deal- to Canada where he married and some of his children were born, then back to Jay, Vermont where other of his children were born, then back to Canada ...then back to Jay where he died 19 Mar 1884.

Diane Brigode
Attachments
Feb 4, 2020, 9:36 AM (4 days ago)
to Andrew, me

Hi Ray,

Thanks for your comments, but I just muddle through as best I can! Will think about the

²³¹ FamilySearch.org, FamilySearch Family Tree, FamilySearch, "Family Tree," database, <i>FamilySearch</i> (<http://familysearch.org> : modified 21 July 2014, 20:49), entry for Giles Sears(PID <https://familysearch.org/ark:/61903/4:1:KH7H-BD7>); contributed by various users. PersonID KH7H-BD7. Giles Sears. <https://familysearch.org/ark:/61903/4:1:KH7H-BD7>.

²³² Ancestry.com, Canada, Find A Grave Index, 1600s-Current (Provo, UT, USA, Ancestry.com Operations, Inc., 2012), Ancestry.com, Record for Giles Sears. <http://search.ancestry.com/cgi-bin/sse.dll?db=60527&h=3263891&indiv=try>.

²³³ Ancestry.com, Vermont, Vital Records, 1720-1908 (Provo, UT, USA, Ancestry.com Operations, Inc., 2013), Ancestry.com, Record for Giles Sears. <http://search.ancestry.com/cgi-bin/sse.dll?db=4661&h=664835&indiv=try>.

publishing.

A couple of other things I'm going to send. I don't know what you do with things like this first one.

1) Electa Sears West. The date of death you show (24 September 1873, and buried at the Methodist Cemetery in Farnham Quebec for Electa. It is the date Vivian gave me. This has found it's way to findagrave also. But I am including her death record from the Vermont Vital Records Index, which gives her date of death as 28 February 1879 at Jay, Vermont. Electa and husband Erastus lived at Jay in 1860 and 1870 - and Erastus was there with a son in 1880. Findagrave has Erastus buried at Jay, but there is no stone or anything. Don't know the source. "E. West" on the stone at Farnham is sort of vague - there could have been several E. Wests in the area. But the one in the Jay death record is quite specific. So anyway, that's that! Do you have anything further on this, or any thoughts?

Vermont Vital Records Index
West, Erastus
Age: 79 years, 7 months, 12 days
Occupation: Farmer
Born Alburgh
Father: Peter West
Mother: Prudence
Died March 19, 1884
Cause: old age
Recorded at Jay

Vermont Vital Records Index - Deaths - Jay, Vermont
Name: West, Electa (Sears)
Age 65 years, 7 months, 2 days
Father's name: Lyman Sears
Mother's Maiden Name: Hannah
Died Feb. 28, 1879
Cause: Heart Disease

2) I'm including a FGS for the family of Thirza Sears and Ephraim Hawley also. My sources generally are church records, Cemetery records, and a large Hawley family tree I received from Quebec. Maybe some notarial docs here and there. Can be more specific.

Diane Sears Brigode.

- m III. **James Sears Jr**{ XE "Sears:James Jr (1821-)" \f "Name" \b } was born in 1821.
James Sears Jr married **Charlotte Davis**{ XE "Davis:Charlotte (1824-)" \f "Name" \b \i }. They had ten children: Nathan (1842-), Melissa (1844-), Aaron (1847-), Tib (1848-), Mary (1850-), Lois (1854-), George (1857-), Arvilla (1859-), W (1865-) and Alice (1869-).
Charlotte was born in 1824.
- f IV. **Clarissa Sears**{ XE "Sears:Clarissa" \f "Name" \b }.
Clarissa Sears married **John Washer**{ XE "Washer:John (1786-1771)" \f "Name" \b \i }. They had one daughter: Charlott (1835-1914).
He reached -15 years of age and died on 11th May 1771. John was born in 1786.
d. date of 11 May 1771 must be wrong?

Family of Jared Sears and Betsy Robinson{ TC "Jared Sears and Betsy Robinson" \I 3 \f C}

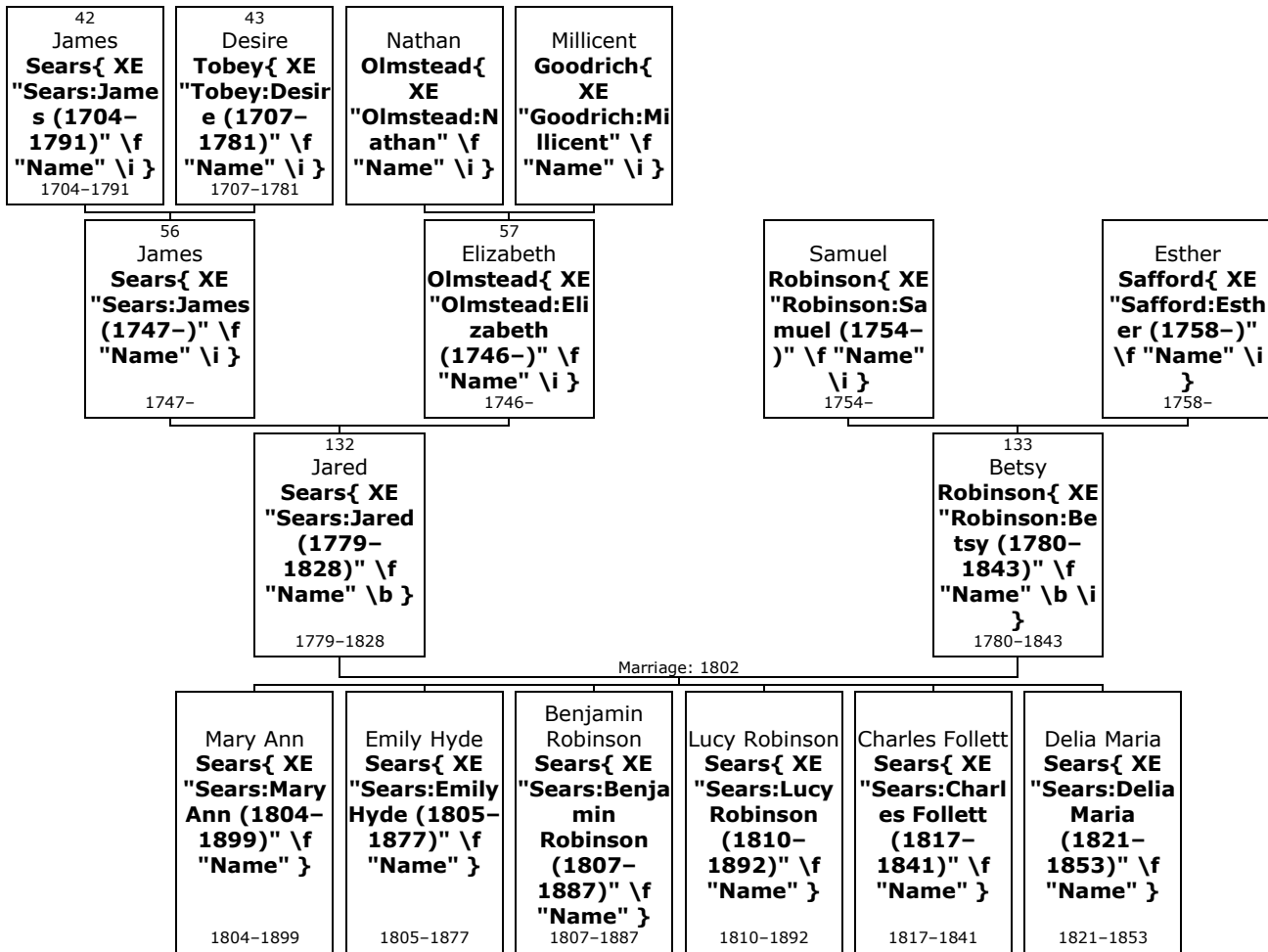

- 132.** **Jared⁴ Sears**{ XE "Sears:Jared (1779-1828)" \f "Name" \b } (*James³, James²*) was born on Thursday, 12th August 1779, in Lenox, Berkshire, Massachusetts, USA{ XE "USA, Massachusetts, Berkshire, Lenox:(42.3565° N, 73.2849° W):Sears, Jared (1779-1828)" \f "Place" }. He was the son of James Sears{ XE "Sears:James (1747-)" \f "Name" \i } (56) and Elizabeth Olmstead{ XE "Olmstead:Elizabeth (1746-)" \f "Name" \i } (57).

Jared died in Knowlesville, Orleans, New York,{ XE "USA, New York, Orleans, Knowlesville:(43.2419° N, 78.3108° W):Sears, Jared (1779-1828)" \f "Place" } on 6th February 1828, at the age of 48. He was buried in Bennington, Vermont{ XE "USA, Vermont, Bennington:(43.0293° N, 73.1084° W):Sears, Jared (1779-1828)" \f "Place" }.

Cassano, Lynne M., ed. Bennington, Vermont Cemetery Inscriptions. [database online] Orem, UT: Ancestry, Inc., 1999. 0A M JEAN & STEPHEN KOSCHE SEARS JERED BE008 F 0 6 FEB 1828 0 0 0 KNOWLESVILLE, NY H/O BETSEY SEARS 2868 0264 M F F U U F 2 5323FT1997

<https://www.wikitree.com/wiki/Sears-872>

- 133.** At the age of 22, Jared married **Betsy Robinson**{ XE "Robinson:Betsy (1780-1843)" \f "Name" \b \i } on Thursday, 11th February 1802, in Bennington{ XE "USA, Vermont, Bennington:(43.0293° N, 73.1084° W):Sears, Jared (1779-1828)" \f "Place" } when she was 21 years old. They had six children: Mary (1804-1899), Emily (1805-1877), Benjamin (1807-1887), Lucy (1810-1892), Charles (1817-1841) and Delia (1821-1853).

Betsy was born in Bennington{ XE "USA, Vermont, Bennington:(43.0293° N, 73.1084° W):Robinson, Betsy (1780-1843)" \f "Place" } on Tuesday, 18th April 1780. She was the daughter of Samuel Robinson{ XE "Robinson:Samuel (1754-)" \f "Name" \i } and Esther Safford{ XE "Safford:Esther (1758-)" \f "Name" \i }.

Betsy reached 63 years of age and died in Bennington{ XE "USA, Vermont, Bennington:(43.0293° N, 73.1084° W):Robinson, Betsy (1780–1843)" \f "Place" } on 1st November 1843.

Cassano, Lynne M., ed. Bennington, Vermont Cemetery Inscriptions. [database online] Orem, UT: Ancestry, Inc., 1999. 0A F JEAN & STEPHEN KOSCHE SEARS BETSEY BE008 F 18 APR 1780 1 NOV 1843 64 0 0 0 W/O JERED SEARS 2867 0264 M F F U U F 2 5323FT1997

Children of Jared Sears and Betsy Robinson:

- f I. **Mary Ann⁵ Sears**{ XE "Sears:Mary Ann (1804–1899)" \f "Name" \b } was born in Swanton, Franklin,{ XE "USA, Vermont, Franklin, Swanton:(44.9181° N, 73.1243° W):Sears, Mary Ann (1804–1899)" \f "Place" } on 5th April 1804. She died in Grass Valley, Nevada, California,{ XE "USA, California, Nevada, Grass Valley:(39.2191° N, 121.0611° W):Sears, Mary Ann (1804–1899)" \f "Place" } in 1899 at the age of 94.
- At the age of 26, Mary Ann married **Martin Story Norton**{ XE "Norton:Martin Story (1788–1875)" \f "Name" \b \i } on Monday, 10th May 1830, in Bennington, Vermont,{ XE "USA, Vermont, Bennington:(43.0293° N, 73.1084° W):Sears, Mary Ann (1804–1899)" \f "Place" } when he was 41 years old. They had one daughter: Catherine (1833–1842).
- Martin Story was born in Bennington{ XE "USA, Vermont, Bennington:(43.0293° N, 73.1084° W):Norton, Martin Story (1788–1875)" \f "Place" } on Friday, 21st November 1788. He was the son of Martin Story Norton{ XE "Norton:Martin Story (1762–)" \f "Name" \i }.
- Martin Story reached 86 years of age and died in Grass Valley, Nevada, California,{ XE "USA, California, Nevada, Grass Valley:(39.2191° N, 121.0611° W):Norton, Martin Story (1788–1875)" \f "Place" } on 11th February 1875.
- f II. **Emily Hyde Sears**{ XE "Sears:Emily Hyde (1805–1877)" \f "Name" \b } was born in Swanton{ XE "USA, Vermont, Franklin, Swanton:(44.9181° N, 73.1243° W):Sears, Emily Hyde (1805–1877)" \f "Place" } on 20th September 1805. She died on 8th April 1877, at the age of 71. Emily Hyde was buried in Charlotte{ XE "USA, Michigan, Eaton, Charlotte:(42.5637° N, 84.8358° W):Sears, Emily Hyde (1805–1877)" \f "Place" } in 1887.

More facts and events for Emily Hyde Sears:

Residence: 1880 Charlotte{ XE "USA, Michigan, Eaton, Charlotte:(42.5637° N, 84.8358° W):Sears, Emily Hyde (1805–1877)" \f "Place" }

At the age of 26, Emily Hyde Sears married **Henry Robinson**{ XE "Robinson:Henry (1809–1891)" \f "Name" \b \i } on Saturday, 21st April 1832, in Bennington, Vermont,{ XE "USA, Vermont, Bennington:(43.0293° N, 73.1084° W):Sears, Emily Hyde (1805–1877)" \f "Place" } when he was 23 years old. They had five children: Benjamin (1833–1833), Charles (1834–), James (1837–1865), Elizabeth (1840–1842) and Samuel (1843–1900).

Henry was born in Bennington{ XE "USA, Vermont, Bennington:(43.0293° N, 73.1084° W):Robinson, Henry (1809–1891)" \f "Place" } on Sunday, 5th February 1809. He worked as a REVEREND.

Henry reached 82 years of age and died on 11th April 1891. He was buried in Vermontville{ XE "USA, Michigan, Eaton, Vermontville:(42.6289° N, 85.0242° W):Robinson, Henry (1809–1891)" \f "Place" }.

- m III. **Benjamin Robinson Sears**{ XE "Sears:Benjamin Robinson (1807–1887)" \f "Name" \b } was born in Bennington{ XE "USA, Vermont, Bennington:(43.0293° N, 73.1084° W):Sears, Benjamin Robinson (1807–1887)" \f "Place" } on 21st December 1807.^[234, 235] He was known by the title of Hon.



Benjamin

Benjamin Robinson died in Bennington{ XE "USA, Vermont, Bennington:(43.0293° N, 73.1084° W):Sears, Benjamin Robinson (1807–1887)" \f "Place" } on 14th December 1887, at the age of 79.^[234] He was buried in Bennington{ XE "USA, Vermont, Bennington:(43.0293° N, 73.1084° W):Sears, Benjamin Robinson (1807–1887)" \f "Place" }.^[234]

At the age of 23, Hon Benjamin Robinson Sears married **Mary Ann Waters**{ XE "Waters:Mary Ann (1805–1887)" \f "Name" \b \i } on Sunday, 20th November 1831, in Bennington{ XE "USA, Vermont, Bennington:(43.0293° N, 73.1084° W):Sears, Benjamin Robinson (1807–1887)" \f "Place" } when she was 26 years old.^[234, 235] They had eight children: Betsy (1833–1890), Martin (1835–1837), Mary (1837–1884), Esther (1839–1870), Charles (1841–1926), Delia (1843–1892), George (1847–1928) and Walter (1849–1894).

Mary Ann was born in Bennington{ XE "USA, Vermont, Bennington:(43.0293° N, 73.1084° W):Waters, Mary Ann (1805–1887)" \f "Place" } on Monday, 28th October 1805.^[234, 235] She was the daughter of Adam Waters{ XE "Waters:Adam (1779–)" \f "Name" \i }.

Mary Ann reached 81 years of age and died in Bennington{ XE "USA, Vermont, Bennington:(43.0293° N, 73.1084° W):Waters, Mary Ann (1805–1887)" \f "Place" } on 3rd July 1887.^[234] She was buried in Bennington, Bennington{ XE "USA, Vermont, Bennington:(42.8781° N, 73.1968° W):Waters, Mary Ann (1805–1887)" \f "Place" }.^[234]

!Benj. R Sears, Jr dau of Adam Waters. Sunday, 20 Nov 1831. Ben. R. Sears was this eve'g by Mr Teesdell wedd'd to Miss M A Waters - likewise by the same at the house of s'd Sears - Mr Zebinah Forbes[sic] of Middleton, VT to Miss Lucy R Sears of this Village. Adeline was present at these weddings which by previous arangement were attended only by a few. From the diary of Benjamin Harwood of Bennington, VT OE 0001 F LC SEARS MARY ANN BE008 F WATERS 28 OCT 1805 3 JUL 1887 0 0 0 0 W/O BENJAMIN R. SEARS 552 000B M G U G 1 FT1997

- f IV. **Lucy Robinson Sears**{ XE "Sears:Lucy Robinson (1810–1892)" \f "Name" \b } was born in St Albans, Franklin,{ XE "USA, Vermont, Franklin, St Albans:(44.8108° N, 73.0836° W):Sears, Lucy Robinson (1810–1892)" \f "Place" } on 13th February 1810. She died on 10th February 1892, at the age of 81.

At the age of 21, Lucy Robinson Sears married **Zebina Eaton Fobes**{ XE "Fobes:Zebina Eaton (1804–1886)" \f "Name" \b \i } on Sunday, 20th November 1831, in St Albans{ XE "USA, Vermont, Franklin, St Albans:(44.8108° N, 73.0836° W):Sears, Lucy Robinson (1810–1892)" \f "Place" } when he was 27 years old. They had two daughters: Evanette (1832–) and Harriet (1836–1904).

Zebina Eaton was born in Middleborough, Plymouth, Massachusetts,{ XE "USA, Massachusetts, Plymouth, Middleborough:(41.8945° N, 70.9069° W):Fobes, Zebina Eaton (1804–1886)" \f "Place" } on Monday, 19th November 1804. He reached 81 years of age and died on 29th May 1886.

- m V. **Charles Follett Sears**{ XE "Sears:Charles Follett (1817–1841)" \f "Name" \b } was born in Bennington{ XE "USA, Vermont, Bennington:(43.0293° N, 73.1084° W):Sears, Charles Follett (1817–1841)" \f "Place" } on 26th August 1817. He died in New Orleans, Orleans, Louisiana,{ XE "USA, Louisiana, Orleans, New Orleans:(29.9547° N, 90.0751° W):Sears, Charles Follett (1817–1841)" \f "Place" } in 1841 at the age of 23.

²³⁴ Ancestry.com, U.S., Find A Grave Index, 1600s-Current (Provo, UT, USA, Ancestry.com Operations, Inc., 2012), Ancestry.com.

²³⁵ Ancestry.com, U.S., Sons of the American Revolution Membership Applications, 1889-1970 (Provo, UT, USA, Ancestry.com Operations, Inc., 2011), Ancestry.com.

f VI. **Delia Maria Sears**{ XE "Sears:Delia Maria (1821-1853)" \f "Name" \b } was born in Bennington{ XE "USA, Vermont, Bennington:(43.0293° N, 73.1084° W):Sears, Delia Maria (1821-1853)" \f "Place" } on 25th August 1821. She died on 1st August 1853, at the age of 31.

At the age of 24, Delia Maria Sears married **Zimri Haswell**{ XE "Haswell:Zimri (1817-1858)" \f "Name" \b \i } on Thursday, 19th March 1846, in Bennington{ XE "USA, Vermont, Bennington:(43.0293° N, 73.1084° W):Sears, Delia Maria (1821-1853)" \f "Place" } when he was 28 years old. They had no known children.

Zimri was born in Shoreham, Addison,{ XE "USA, Vermont, Addison, Shoreham:(43.8936° N, 73.3164° W):Haswell, Zimri (1817-1858)" \f "Place" } on Monday, 1st September 1817. He reached 40 years of age and died in San Francisco, California,{ XE "USA, California, San Francisco:(37.7933° N, 122.5548° W):Haswell, Zimri (1817-1858)" \f "Place" } on 22nd April 1858.

Family of Betsy Sears and Joseph Montague{ TC "Betsy Sears and Joseph Montague" \I 3 \f C}

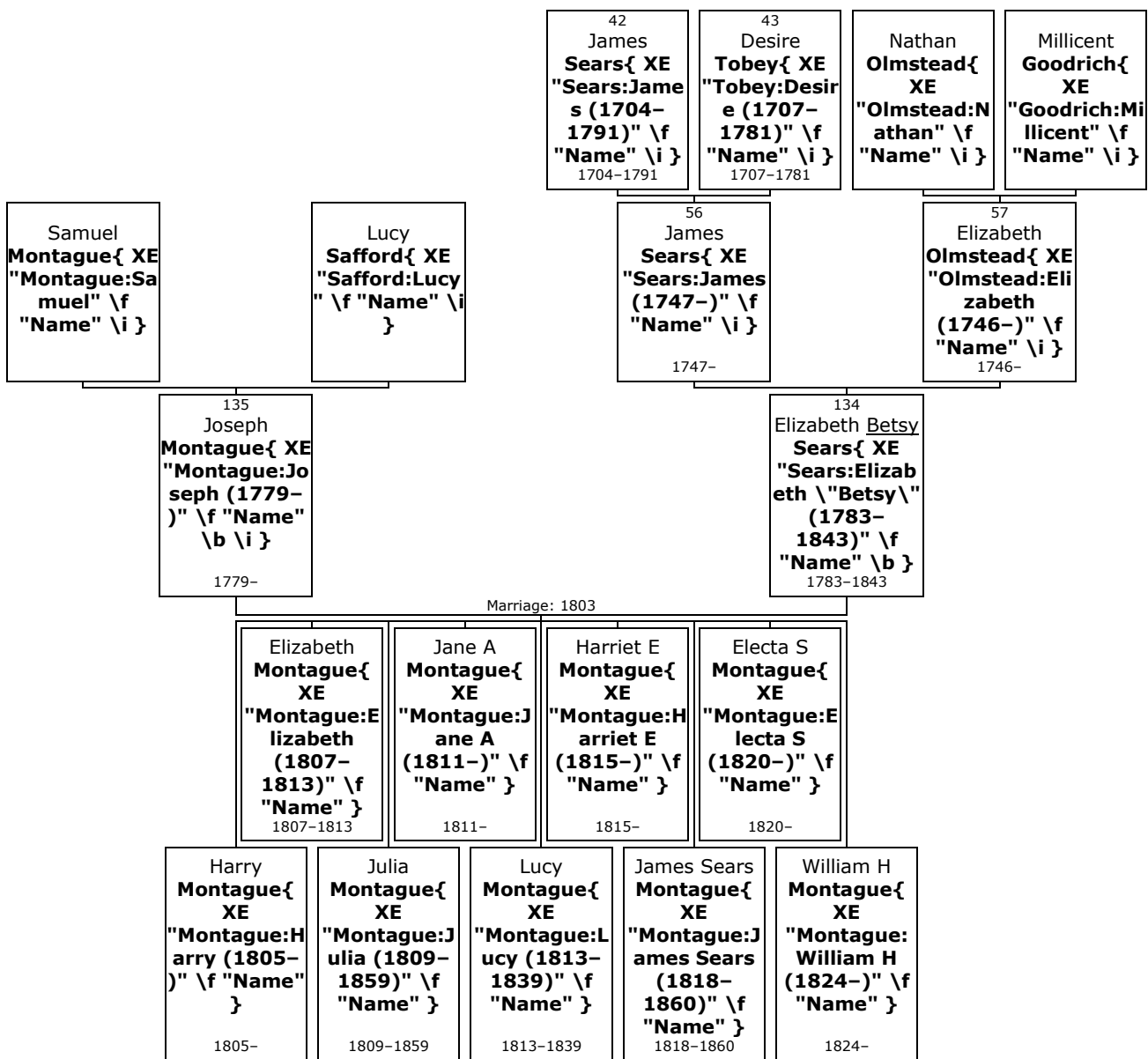

134. **Elizabeth Betsy⁴ Sears**{ XE "Sears:Elizabeth \"Betsy\" (1783-1843)" \f "Name" \b } (*James³, James²*) was born in August 1783 in Arlington, Bennington, Vermont, USA{ XE "USA, Vermont, Bennington, Arlington:(43.0748° N, 73.154° W):Sears, Elizabeth \"Betsy\" (1783-1843)" \f "Place" }. She was the

daughter of James Sears{ XE "Sears:James (1747-)" \f "Name" \i } (56) and Elizabeth Olmstead{ XE "Olmstead:Elizabeth (1746-)" \f "Name" \i } (57).

Betsy died in Fletcher, Franklin,{ XE "USA, Vermont, Franklin, Fletcher:(44.6833° N, 72.9142° W):Sears, Elizabeth \"Betsy\" (1783-1843)" \f "Place" } on 6th July 1843, at the age of 59.

!DSB-The Montague Family in America, rev by William L Montague, pub Amherst, MA-1886, says Elizabeth was from Sutton, province of Quebec. Alt d. date 5 Jul 1845.

- 135.** Betsy married **Joseph Montague**{ XE "Montague:Joseph (1779-)" \f "Name" \b \i } in 1803. They had nine children: Harry (1805-), Elizabeth (1807-1813), Julia (1809-1859), Jane (1811-), Lucy (1813-1839), Harriet (1815-), James (1818-1860), Electa (1820-) and William (1824-).

Joseph was born in Cambridge, Lamoille,{ XE "USA, Vermont, Lamoille, Cambridge:(44.6448° N, 72.8762° W):Montague, Joseph (1779-)" \f "Place" } in 1779. He was the son of Samuel Montague{ XE "Montague:Samuel" \f "Name" \i } and Lucy Safford{ XE "Safford:Lucy" \f "Name" \i }.

Children of Elizabeth Betsy Sears and Joseph Montague:

- m I. **Harry⁵ Montague**{ XE "Montague:Harry (1805-)" \f "Name" \b } was born in Swanton, Franklin,{ XE "USA, Vermont, Franklin, Swanton:(44.9181° N, 73.1243° W):Montague, Harry (1805-)" \f "Place" } on 28th June 1805.
- f II. **Elizabeth Montague**{ XE "Montague:Elizabeth (1807-1813)" \f "Name" \b } was born in perh, Swanton,{ XE "USA, Vermont, Franklin, Swanton, perh: :Montague, Elizabeth (1807-1813)" \f "Place" } in 1807. She died in St Albans{ XE "USA, Vermont, Franklin, St Albans:(44.8108° N, 73.0836° W):Montague, Elizabeth (1807-1813)" \f "Place" } in 1813 at the age of 6.
- Elizabeth married (**unknown given name**) **Porter**{ XE "Porter: (1803-)" \f "Name" \b \i }. They had no known children.
- (unknown given name) was born in Hadley, Hampshire, Massachusetts,{ XE "USA, Massachusetts, Hampshire, Hadley:(42.3418° N, 72.5884° W):Porter, (1803-)" \f "Place" } in 1803.
- f III. **Julia Montague**{ XE "Montague:Julia (1809-1859)" \f "Name" \b } was born in perh{ XE "USA, Vermont, Franklin, Swanton, perh: :Montague, Julia (1809-1859)" \f "Place" } on 2nd July 1809. She died in April 1859 at the age of 49.
- f IV. **Jane A Montague**{ XE "Montague:Jane A (1811-)" \f "Name" \b } was born in perh{ XE "USA, Vermont, Franklin, Swanton, perh: :Montague, Jane A (1811-)" \f "Place" } on 15th October 1811.
- f V. **Lucy Montague**{ XE "Montague:Lucy (1813-1839)" \f "Name" \b } was born in perh{ XE "USA, Vermont, Franklin, Swanton, perh: :Montague, Lucy (1813-1839)" \f "Place" } in November 1813. She died in 1839 at the age of 25.
- f VI. **Harriet E Montague**{ XE "Montague:Harriet E (1815-)" \f "Name" \b } was born in perh{ XE "USA, Vermont, Franklin, Swanton, perh: :Montague, Harriet E (1815-)" \f "Place" } on 3rd September 1815.
- m VII. **James Sears Montague**{ XE "Montague:James Sears (1818-1860)" \f "Name" \b } was born in perh{ XE "USA, Vermont, Franklin, Swanton, perh: :Montague, James Sears (1818-1860)" \f "Place" } in 1818. He died in 1860 at the age of 42.
- f VIII. **Electa S Montague**{ XE "Montague:Electa S (1820-)" \f "Name" \b } was born in perh{ XE "USA, Vermont, Franklin, Swanton, perh: :Montague, Electa S (1820-)" \f "Place" } in 1820.
- Electa S married **Jonathan Edwards Porter**{ XE "Porter:Jonathan Edwards" \f "Name" \b \i }.
- m IX. **William H Montague**{ XE "Montague:William H (1824-)" \f "Name" \b } was born in perh{ XE "USA, Vermont, Franklin, Swanton, perh: :Montague, William H (1824-)" \f "Place" } on 24th October 1824.
- William H married **Laura H Potter**{ XE "Potter:Laura H" \f "Name" \b \i }.

Family of Millicent Sears and Bradley Castle{ TC "Millicent Sears and Bradley Castle" \I 3 \f C}

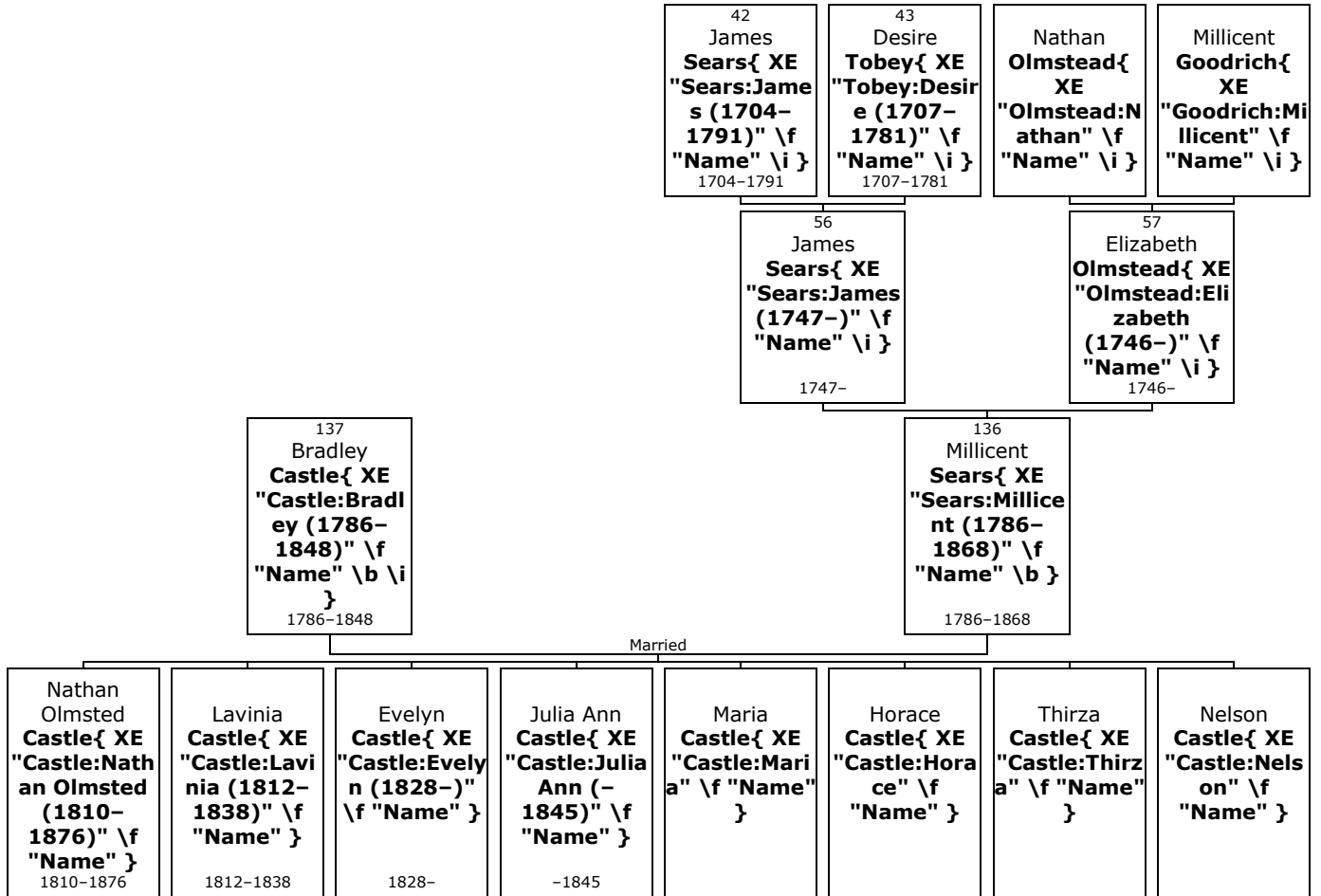

136. Millicent⁴ Sears{ XE "Sears:Millicent (1786-1868)" \f "Name" \b } (*James³, James²*) was born on Saturday, 15th April 1786, in Vermont, USA{ XE "USA, Vermont:(43.8726° N, 71.55° W):Sears, Millicent (1786-1868)" \f "Place" }. She was the daughter of James Sears{ XE "Sears:James (1747-)\" \f "Name" \i } (56) and Elizabeth Olmstead{ XE "Olmstead:Elizabeth (1746-)\" \f "Name" \i } (57).

Millicent was christened in Stukeley, Quebec, Canada,{ XE "Canada, Quebec, Stukeley: :Sears, Millicent (1786-1868)" \f "Place" } on 9th October 1853. She died in Shefford, La Haute-Yamaska,{ XE "Canada, Quebec, La Haute-Yamaska, Shefford:(45.4167° N, 72.5833° W):Sears, Millicent (1786-1868)" \f "Place" } on 29th April 1868, at the age of 82. Millicent was buried on 2nd May 1868.

!BIRTH-CHRISTENING-CHILDREN-DEATH: Letter from Diane Sears Brigode, Northglenn, CO, to Ray Sears in Duncan, OK; 1830-1915; Letter dtd 27 Jan 1994; ; copy in poss of Ray Sears; Family Group Sheets.
 !DSB-Several suspected children of Millicent and Bradley, but none confirmed as of yet, except Nathan Olmsted Castle.

137. Millicent married **Bradley Castle**{ XE "Castle:Bradley (1786-1848)" \f "Name" \b \i } in Quebec{ XE "Canada, Quebec:(47.4278° N, 71.8805° W):Sears, Millicent (1786-1868)" \f "Place" }. They had eight children: Nathan (1810-1876), Lavinia (1812-1838), Evelyn (1828-), Julia (-1845), Maria, Horace, Thirza and Nelson.

Bradley was born in 1786. He reached 62 years of age and died in Shefford, La Haute-Yamaska, Quebec,{ XE "Canada, Quebec, La Haute-Yamaska, Shefford:(45.4167° N, 72.5833° W):Castle, Bradley (1786-1848)" \f "Place" } on 13th March 1848. Bradley was buried in Waterloo Burial Ground, Shefford,{ XE "Canada, Quebec, La Haute-Yamaska, Shefford, Waterloo Burial Ground: :Castle, Bradley (1786-1848)" \f "Place" } on 15th March 1848.

!BIRTH-DEATH: Letter from Diane Sears Brigode, Northglenn, CO, to Ray Sears in Duncan, OK; 1830-1915; Letter dtd 27 Jan 1994; ; copy in poss of Ray Sears; Family Group Sheets.

Children of Millicent Sears and Bradley Castle:

- m I. **Nathan Olmsted⁵ Castle**{ XE "Castle:Nathan Olmsted (1810–1876)" \f "Name" \b } was born in Shefford, La Haute-Yamaska, Quebec,{ XE "Canada, Quebec, La Haute-Yamaska, Shefford:(45.4167° N, 72.5833° W):Castle, Nathan Olmsted (1810–1876)" \f "Place" } on 20th May 1810. He died in Afton, Washington, Minnesota, USA,{ XE "USA, Minnesota, Washington, Afton:(44.9028° N, 92.7835° W):Castle, Nathan Olmsted (1810–1876)" \f "Place" } on 24th August 1876, at the age of 66.
Nathan Olmsted married **Rosetta Savage**{ XE "Savage:Rosetta" \f "Name" \b \i }.
Nathan Olmsted married **Phebe Lawrence**{ XE "Lawrence:Phebe" \f "Name" \b \i }.
- f II. **Lavinia Castle**{ XE "Castle:Lavinia (1812–1838)" \f "Name" \b } was born in Quebec{ XE "Canada, Quebec:(47.4278° N, 71.8805° W):Castle, Lavinia (1812–1838)" \f "Place" } in 1812. She was christened in Shefford, La Haute-Yamaska, Quebec,{ XE "Canada, Quebec, La Haute-Yamaska, Shefford:(45.4167° N, 72.5833° W):Castle, Lavinia (1812–1838)" \f "Place" } on 16th February 1837. Lavinia died in Frost Village, Shefford,{ XE "Canada, Quebec, La Haute-Yamaska, Shefford, Frost Village: :Castle, Lavinia (1812–1838)" \f "Place" } on 29th September 1838, at the age of 26. She was buried on 2nd October 1838. Public Burial Ground, Frost Village, Quebec.
Lavinia married **Jarvis C Ellis**{ XE "Ellis:Jarvis C" \f "Name" \b \i }.
- f III. **Evelyn Castle**{ XE "Castle:Evelyn (1828–)" \f "Name" \b } was born in 1828.
Evelyn married **Shepard Parker Bunker**{ XE "Bunker:Shepard Parker" \f "Name" \b \i }.
- f IV. **Julia Ann Castle**{ XE "Castle:Julia Ann (–1845)" \f "Name" \b }. Julia Ann died in Shefford, La Haute-Yamaska, Quebec,{ XE "Canada, Quebec, La Haute-Yamaska, Shefford:(45.4167° N, 72.5833° W):Castle, Julia Ann (–1845)" \f "Place" } on 30th July 1845.
Julia Ann married **Gardner Kneeland**{ XE "Kneeland:Gardner" \f "Name" \b \i }.
- f V. **Maria Castle**{ XE "Castle:Maria" \f "Name" \b }.
Maria married **Lindsey Day**{ XE "Day:Lindsey" \f "Name" \b \i }.
- m VI. **Horace Castle**{ XE "Castle:Horace" \f "Name" \b }.
- f VII. **Thirza Castle**{ XE "Castle:Thirza" \f "Name" \b }.
- m VIII. **Nelson Castle**{ XE "Castle:Nelson" \f "Name" \b }.
Nelson married **Elizabeth Spinney**{ XE "Spinney:Elizabeth" \f "Name" \b \i }.
Nelson married **Hannah Lawrence**{ XE "Lawrence:Hannah" \f "Name" \b \i }.

Family of Eber Crosby and Esther Raymond{ TC "Eber Crosby and Esther Raymond" \I 3 \f C}

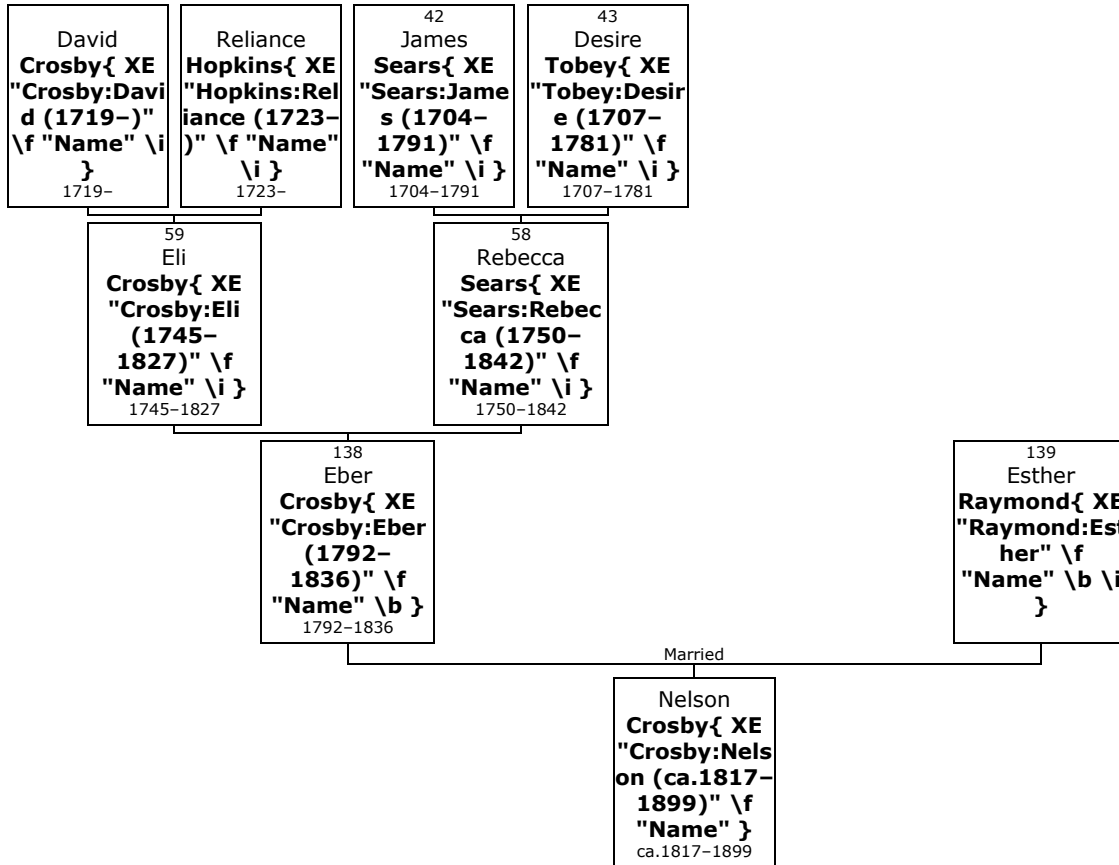

138. Eber⁴ Crosby{ XE "Crosby:Eber (1792-1836)" \f "Name" \b } (*Rebecca³ Sears, James²*) was born on Saturday, 8th September 1792, in Brewster, Putnam, New York, USA{ XE "USA, New York, Putnam, Brewster:(41.3973° N, 73.6171° W):Crosby, Eber (1792-1836)" \f "Place" }. He was the son of Eli Crosby{ XE "Crosby:Eli (1745-1827)" \f "Name" \i } (59) and Rebecca Sears{ XE "Sears:Rebecca (1750-1842)" \f "Name" \i } (58).

Eber died in Southeast{ XE "USA, New York, Putnam, Southeast:(41.4054° N, 73.6001° W):Crosby, Eber (1792-1836)" \f "Place" } on 16th May 1836, at the age of 43.

139. He married **Esther Raymond**{ XE "Raymond:Esther" \f "Name" \b \i }. They had one son: Nelson (ca.1817-1899).

Son of Eber Crosby and Esther Raymond:

- m I. **Nelson⁵ Crosby**{ XE "Crosby:Nelson (ca.1817-1899)" \f "Name" \b } was born in Putnam{ XE "USA, New York, Putnam:(41.4314° N, 73.7464° W):Crosby, Nelson (ca.1817-1899)" \f "Place" } about 1817. He died in Walworth, Wisconsin,{ XE "USA, Wisconsin, Walworth:(42.6681° N, 88.5416° W):Crosby, Nelson (ca.1817-1899)" \f "Place" } on 2nd May 1899, at the age of 82.

Family of Thirza Sears and William Sears{ TC "Thirza Sears and William Sears" \I 3 \f C}

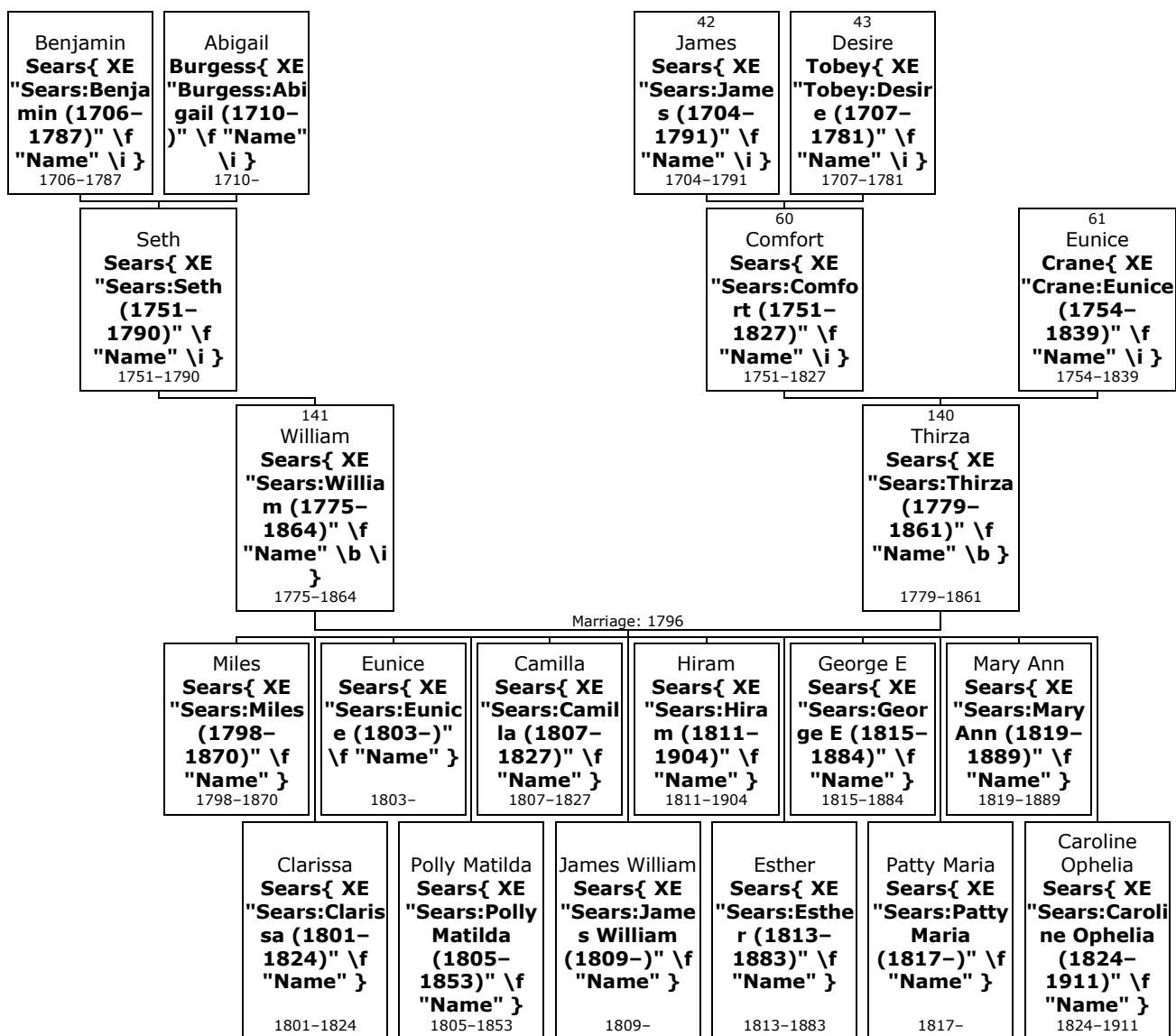

- 140.** **Thirza⁴ Sears**{ XE "Sears:Thirza (1779-1861)" \f "Name" \b \i } (*Comfort³, James²*) was born on Monday, 22nd March 1779, in Joe's Hill, Ridgefield, Fairfield, Connecticut, USA{ XE "USA, Connecticut, Fairfield, Ridgefield, Joe's Hill: :Sears, Thirza (1779-1861)" \f "Place" \i }.^[236, 237-238] She was the daughter of Comfort Sears{ XE "Sears:Comfort (1751-1827)" \f "Name" \i } (60) and Eunice Crane{ XE "Crane:Eunice (1754-1839)" \f "Name" \i } (61).

Thirza died in Neversink{ XE "USA, New York, Sullivan, Neversink:(41.8472° N, 74.6195° W):Sears, Thirza (1779-1861)" \f "Place" \i } on 3rd January 1861, at the age of 81.^[238] She was buried in Mountain Dale{ XE "USA, New York, Sullivan, Mountain Dale:(41.6894° N, 74.5317° W):Sears, Thirza (1779-1861)" \f "Place" \i }.^[238]

S P May No. 782

<https://www.wikitree.com/wiki/Sears-4785>

²³⁶ Samuel P. May, The Descendants of Richard Sares (Sears) of Yarmouth, Mass. 1638-1888 (Joel Munsell's Sons, Publishers, 1890, Albany, NY), Ray Sears, 2208 Amber RdOklahoma City, OK 73170 / 405/703-0779, Date record was made: 0097/11/06.

²³⁷ Ancestry.com, New York, State Census, 1855 (Provo, UT, USA, Ancestry.com Operations, Inc., 2013), Ancestry.com. [Source citation includes one media item]

²³⁸ "Ancestry Family Tree", Record for Mary (Polly) Matilda Sears. <https://familysearch.org/ark:/61903/1:1:F7WL-GSM>.

More facts and events for Thirza Sears:

- Residence: 1850 Thompson{ XE "USA, New York, Sullivan, Thompson:(41.647° N, 74.6766° W):Sears, Thirza (1779–1861)" \f "Place" }^[238]
- Residence: 1855 Thompson{ XE "USA, New York, Sullivan, Thompson:(41.647° N, 74.6766° W):Sears, Thirza (1779–1861)" \f "Place" }^[237, 238]
Relation to Head of House: Wife
- Residence: 1860 Fallsburg{ XE "USA, New York, Sullivan, Fallsburg:(41.732° N, 74.6017° W):Sears, Thirza (1779–1861)" \f "Place" }^[238]

- 141.** At the age of 17, Thirza married **William Sears**{ XE "Sears:William (1775–1864)" \f "Name" \b \i } on Monday, 24th October 1796, in Ridgefield, Fairfield, Connecticut,{ XE "USA, Connecticut, Fairfield, Ridgefield:(41.2815° N, 73.4982° W):Sears, Thirza (1779–1861)" \f "Place" } when he was 21 years old.^[237–239] They had twelve children: Miles (1798–1870), Clarissa (1801–1824), Eunice (1803–), Polly (1805–1853), Camilla (1807–1827), James (1809–), Hiram (1811–1904), Esther (1813–1883), George (1815–1884), Patty (1817–), Mary (1819–1889) and Caroline (1824–1911).

William was born in Southeast, Putnam, New York,{ XE "USA, New York, Putnam, Southeast:(41.4054° N, 73.6001° W):Sears, William (1775–1864)" \f "Place" } on Thursday, 19th October 1775.^[237–239] He was the son of Seth Sears{ XE "Sears:Seth (1751–1790)" \f "Name" \i }.

William reached 88 years of age and died in Neversink{ XE "USA, New York, Sullivan, Neversink:(41.8472° N, 74.6195° W):Sears, William (1775–1864)" \f "Place" } on 24th May 1864.^[238, 239] He was buried in Mountain Dale{ XE "USA, New York, Sullivan, Mountain Dale:(41.6894° N, 74.5317° W):Sears, William (1775–1864)" \f "Place" }.^[238, 239]

!CHILDREN-DEATH-BIOGRAPHY: GENEALOGICAL AND FAMILY HISTORY of SOUTHERN NEW YORK and the HUDSON RIVER VALLEY, Vol II;1640-1913; Lewis Historical Publishing Co, 1913; pp 507-510; Brewster, NY Public Library; In 1804 he settled in the town of Thompson, Sullivan co, NY, where he cleared land and engaged in farming. He had lived for some time previous in Ridgefield or Stamford, CT.

!

!S P May No. 464 p 129

<https://www.wikitree.com/wiki/Sears-4712>

!

!http://www.usgennet.org/usa/topic/historical/SouthernNewYork2/sny2_pt78.htm (VI) William, son of Seth Sears, was born October 19, 1775, in South East, died in Neversink, New York, May 24, 1864. In 1804 he settled in the town of Thompson, Sullivan County, New York, where he cleared land and engaged in farming. He had lived for some time previous in Ridgefield or Stamford, Connecticut. He married, in Ridgefield, October 24, 1796, Thirza daughter of Comfort and Eunice (Crane) Sears, of Ridgefield. She died January 3, 1861. Children: 1. Miles, of whom further. 2. Clarissa, born October 18, 1801; married S. M. Hoyt; died in Thompson, Sullivan County, New York, April 5, 1824. 3. Eunice, born July 10, 1803; married Sturges Andrus of Mountaindale, New York. 4. Polly Matilda, born April 6, 1805; married E. T. Partridge; died November 3, 1853, in Jamestown, New York. 5. Camilla, born April [Page 509] 13, 1807; became the wife of Alson Lord, of Bridgeville, Sullivan County, New York, died April 1, 1827. 6. James William, born March 12, 1809, went south. 7. Hiram, born March 9, 1811; settled in Gerry, New York; died in Jamestown, New York, aged ninety-six. 8. Esther, born March 19, 1813; married William bowers and lived in Bridgeville. 9. George E., born March 13, 1815, died in 1884, no issue. 10. Patty Maria, born March 10, 1817; married (first) Henry Race, (second) Walter Hoyt; died in Bridgeville. 11. Mary Ann, born April 18, 1819; married Robert Knapp, died without issue. 12. Caroline Ophelia, born May 18, 1824; married James O'Neil and had a large family; lived in Thompson; died in 1911.

More facts and events for William Sears:

- Residence: 1850 Thompson{ XE "USA, New York, Sullivan, Thompson:(41.647° N, 74.6766° W):Sears, William (1775–1864)" \f "Place" }^[238]
- Residence: 1855 Thompson{ XE "USA, New York, Sullivan, Thompson:(41.647° N, 74.6766° W):Sears, William (1775–1864)" \f "Place" }^[237, 238]
Relation to Head of House: Head

²³⁹ Ancestry.com, U.S., Find A Grave Index, 1600s-Current (Provo, UT, USA, Ancestry.com Operations, Inc., 2012), Ancestry.com.

Residence: 1860 Fallsburg{ XE "USA, New York, Sullivan, Fallsburg:(41.732° N, 74.6017° W):Sears, William (1775–1864)" \f "Place" }^[238]

Children of Thirza Sears and William Sears:

- m I. **Miles⁵ Sears**{ XE "Sears:Miles (1798–1870)" \f "Name" \b } was born in Ridgefield{ XE "USA, Connecticut, Fairfield, Ridgefield:(41.2815° N, 73.4982° W):Sears, Miles (1798–1870)" \f "Place" } on 1st December 1798.^[239, 240, 241–242] He died in Rileyville{ XE "USA, Pennsylvania, Wayne, Rileyville: :Sears, Miles (1798–1870)" \f "Place" } in January 1870 at the age of 71.^[239, 241] Miles was buried in Wayne{ XE "USA, Pennsylvania, Wayne:(41.6502° N, 75.3064° W):Sears, Miles (1798–1870)" \f "Place" }.^[239]

More facts and events for Miles Sears:

Residence: 1850 Lebanon, Wayne{ XE "USA, Pennsylvania, Wayne, Lebanon:(40.3409° N, 76.4114° W):Sears, Miles (1798–1870)" \f "Place" }^[240]

Residence: 1860 Damascus{ XE "USA, Pennsylvania, Wayne, Damascus:(41.7031° N, 75.0686° W):Sears, Miles (1798–1870)" \f "Place" }^[242]

At the age of 36, Miles married **Catherine Misner**{ XE "Misner:Catherine (1820–1895)" \f "Name" \b \i } on Tuesday, 6th October 1835, when she was 15 years old. They had seven children: Oliver (1839–1922), Ann (1843–), Mary (1848–), Harriet (1848–), Herman (1852–1916), Caroline (1855–1925) and Helen (1855–).

Catherine was born in Thompson, Sullivan, New York,{ XE "USA, New York, Sullivan, Thompson:(41.647° N, 74.6766° W):Misner, Catherine (1820–1895)" \f "Place" } on Saturday, 4th March 1820. She reached 74 years of age and died in Cold Spring, Lebanon, Pennsylvania,{ XE "USA, Pennsylvania, Lebanon, Cold Spring:(41.5896° N, 76.7327° W):Misner, Catherine (1820–1895)" \f "Place" } in 1895.

BIRTH-DEATH: TAG, Apr 1992, p117-8; CONFLICT: shows her birth year as 1817; Richard Orvis Eldred, Nyack College, Nyack, NY 10960

Miles Sears married **Sally P Bowers**{ XE "Bowers:Sally P (1800–1833)" \f "Name" \b \i } in Glenville, Schenectady, New York{ XE "USA, New York, Schenectady, Glenville:(42.9292° N, 74.0525° W):Sears, Miles (1798–1870)" \f "Place" }. They had six children: John (1823–1907), Clarissa (1826–1897), Alfred (1829–), Charles (1831–1902), Lewis (1834–1908) and George (1837–1864).

Sally P was born in Thompson, Sullivan,{ XE "USA, New York, Sullivan, Thompson:(41.647° N, 74.6766° W):Bowers, Sally P (1800–1833)" \f "Place" } in 1800. She was the daughter of Zephaniah Bowers{ XE "Bowers:Zephaniah" \f "Name" \i }.

Sally P reached 33 years of age and died in Thompson{ XE "USA, New York, Sullivan, Thompson:(41.647° N, 74.6766° W):Bowers, Sally P (1800–1833)" \f "Place" } on 6th October 1833.

IFATHER-BIRTH-CHILDREN-DEATH-BIOGRAPHY: GENEALOGICAL AND FAMILY HISTORY of SOUTHERN NEW YORK and the HUDSON RIVER VALLEY, Vol II;1640-1913; Lewis Historical Publishing Co, 1913; pp 507-510; Brewster, NY Public Library;

- f II. **Clarissa Sears**{ XE "Sears:Clarissa (1801–1824)" \f "Name" \b } was born in perh, Ridgefield,{ XE "USA, Connecticut, Fairfield, Ridgefield, perh: :Sears, Clarissa (1801–1824)" \f "Place" } on 18th October 1801. She died in Thompson, Sullivan, New York,{

²⁴⁰ Ancestry.com, 1850 United States Federal Census (Provo, UT, USA, Ancestry.com Operations, Inc., 2009), Ancestry.com, Year: 1850; Census Place: Lebanon, Wayne, Pennsylvania; Roll: M432_835; Page: 59A; Image: 117.

²⁴¹ Ancestry.com, U.S. Federal Census Mortality Schedules, 1850-1885 (Provo, UT, USA, Ancestry.com Operations, Inc., 2010), Ancestry.com, National Archives and Records Administration (NARA); Washington, D.C.; Non-Population Census Schedules for Pennsylvania, 1850-1880: Mortality; Archive Collection: M1838; Archive Roll Number: 7; Census Year: 1870; Census Place: Lebanon, Wayne, Pennsylvania.

²⁴² Ancestry.com, 1860 United States Federal Census (Provo, UT, USA, Ancestry.com Operations, Inc., 2009), Ancestry.com, Year: 1860; Census Place: Damascus, Wayne, Pennsylvania; Roll: M653_1193; Page: 202; Family History Library Film: 805193.

XE "USA, New York, Sullivan, Thompson:(41.647° N, 74.6766° W):Sears, Clarissa (1801-1824)" \f "Place" } on 5th April 1824, at the age of 22.

Clarissa Sears married **S M Hoyt**{ XE "Hoyt:S M (1797-)" \f "Name" \b \i }. They had no known children.

S M was born in perh, Thompson,{ XE "USA, New York, Sullivan, Thompson, perh: :Hoyt, S M (1797-)" \f "Place" } in 1797.

SPOUSE: GENEALOGICAL AND FAMILY HISTORY of SOUTHERN NEW YORK and the HUDSON RIVER VALLEY, Vol II;1640-1913; Lewis Historical Publishing Co, 1913; pp 507-510; Brewster, NY Public Library;

- f III. **Eunice Sears**{ XE "Sears:Eunice (1803-)" \f "Name" \b } was born in perh{ XE "USA, Connecticut, Fairfield, Ridgefield, perh: :Sears, Eunice (1803-)" \f "Place" } on 9th July 1803.

Eunice married **Sturges Andrus**{ XE "Andrus:Sturges" \f "Name" \b \i }.

- f IV. **Polly Matilda Sears**{ XE "Sears:Polly Matilda (1805-1853)" \f "Name" \b } was born in perh{ XE "USA, Connecticut, Fairfield, Ridgefield, perh: :Sears, Polly Matilda (1805-1853)" \f "Place" } on 6th April 1805.^[238] She died in Jamestown{ XE "USA, New York, Chautauqua, Jamestown:(42.097° N, 79.2353° W):Sears, Polly Matilda (1805-1853)" \f "Place" } on 3rd November 1853, at the age of 48.^[238] Polly Matilda was buried in Chautauqua{ XE "USA, New York, Chautauqua:(42.3015° N, 79.4125° W):Sears, Polly Matilda (1805-1853)" \f "Place" }.^[238]

More facts and events for Polly Matilda Sears:

Residence: 1820 Chautauqua{ XE "USA, New York, Chautauqua:(42.3015° N, 79.4125° W):Sears, Polly Matilda (1805-1853)" \f "Place" }.^[238]

Residence: 1850 Gerry, Chautauqua{ XE "USA, New York, Chautauqua, Gerry:(42.1933° N, 79.2489° W):Sears, Polly Matilda (1805-1853)" \f "Place" }.^[238]

Polly Matilda married **Edward Turner Partridge**{ XE "Partridge:Edward Turner (1799-1887)" \f "Name" \b \i }.^[238] They had six children: Camilla (1834-1906), Edward (1836-1905), Delia (1838-1929), Oscar (1842-1927), George (1844-1860) and Burton (1848-1932).

Edward Turner was born in Wilbraham, Hampden, Massachusetts,{ XE "USA, Massachusetts, Hampden, Wilbraham:(42.1237° N, 72.4315° W):Partridge, Edward Turner (1799-1887)" \f "Place" } on Saturday, 21st December 1799.^[238] He reached 87 years of age and died in Gerry{ XE "USA, New York, Chautauqua, Gerry:(42.1933° N, 79.2489° W):Partridge, Edward Turner (1799-1887)" \f "Place" } on 25th September 1887.^[238] Edward Turner was buried in Chautauqua{ XE "USA, New York, Chautauqua:(42.3015° N, 79.4125° W):Partridge, Edward Turner (1799-1887)" \f "Place" }.^[238]

!SPOUSE: GENEALOGICAL AND FAMILY HISTORY of SOUTHERN NEW YORK and the HUDSON RIVER VALLEY, Vol II;1640-1913; Lewis Historical Publishing Co, 1913; pp 507-510; Brewster, NY Public Library;

- f V. **Camilla Sears**{ XE "Sears:Camilla (1807-1827)" \f "Name" \b } was born in perh{ XE "USA, Connecticut, Fairfield, Ridgefield, perh: :Sears, Camilla (1807-1827)" \f "Place" } on 13th April 1807. She died on 1st April 1827, at the age of 19.

Camilla married **Alson Lord**{ XE "Lord:Alson" \f "Name" \b \i }.

- m VI. **James William Sears**{ XE "Sears:James William (1809-)" \f "Name" \b } was born in perh{ XE "USA, Connecticut, Fairfield, Ridgefield, perh: :Sears, James William (1809-)" \f "Place" } on 12th March 1809.

- m VII. **Hiram Sears**{ XE "Sears:Hiram (1811-1904)" \f "Name" \b } was born in perh{ XE "USA, Connecticut, Fairfield, Ridgefield, perh: :Sears, Hiram (1811-1904)" \f "Place" }

on 9th March 1811.^[239, 243, 244] He died in Jamestown{ XE "USA, New York, Chautauqua, Jamestown:(42.097° N, 79.2353° W):Sears, Hiram (1811–1904)" \f "Place" } in 1904 at the age of 92.^[239] Hiram was buried in Gerry{ XE "USA, New York, Chautauqua, Gerry:(42.1933° N, 79.2489° W):Sears, Hiram (1811–1904)" \f "Place" }.^[239]

More facts and events for Hiram Sears:

Residence: 1865 Gerry{ XE "USA, New York, Chautauqua, Gerry:(42.1933° N, 79.2489° W):Sears, Hiram (1811–1904)" \f "Place" }^[244]
Relation to Head of House: Head

Residence: 1880 Gerry{ XE "USA, New York, Chautauqua, Gerry:(42.1933° N, 79.2489° W):Sears, Hiram (1811–1904)" \f "Place" }^[243]
Marital status: Married; Relation to Head of House: Self

Hiram married **Laurilla Shepardson**{ XE "Shepardson:Laurilla (1818–1850)" \f "Name" \b \i } in 1838 in New York{ XE "USA, New York:(42.7531° N, 74.2224° W):Sears, Hiram (1811–1904)" \f "Place" }.^[239] They had three children: Corydon (ca.1841–), Ophelia (1845–1923) and George (1849–1867).

Laurilla was born in Guilford, Windham County, Vermont,{ XE "USA, Vermont, Windham County, Guilford:(42.8178° N, 72.577° W):Shepardson, Laurilla (1818–1850)" \f "Place" } on Thursday, 8th January 1818.^[239] She was the daughter of Pliny Shepardson{ XE "Shepardson:Pliny (1796–1871)" \f "Name" \i } and Rachel --Shepardson{ XE "--Shepardson:Rachel (1798–1864)" \f "Name" \i }.

Laurilla reached 31 years of age and died in Chautauqua, New York,{ XE "USA, New York, Chautauqua:(42.3015° N, 79.4125° W):Shepardson, Laurilla (1818–1850)" \f "Place" } in 1850.^[239] She was buried in Gerry, Chautauqua{ XE "USA, New York, Chautauqua, Gerry:(42.1933° N, 79.2489° W):Shepardson, Laurilla (1818–1850)" \f "Place" }.^[239]

Hiram Sears married **Mary --Sears**{ XE "--Sears:Mary (ca.1807–)" \f "Name" \b \i } on Friday, 20th May 1853, in Lebanon, Madison{ XE "USA, New York, Madison, Lebanon:(42.7814° N, 75.6481° W):Sears, Hiram (1811–1904)" \f "Place" }.^[243, 244] They had one daughter: Arilla (ca.1855–).

Mary was born in New York{ XE "USA, New York:(42.7531° N, 74.2224° W):--Sears, Mary (ca.1807–)" \f "Place" } about 1807.^[243, 244]

- f VIII. **Esther Sears**{ XE "Sears:Esther (1813–1883)" \f "Name" \b } was born in perh{ XE "USA, Connecticut, Fairfield, Ridgefield, perh: :Sears, Esther (1813–1883)" \f "Place" } on 9th March 1813.^[245] She died in 1883 at the age of 69.^[245]

Esther Sears married **William Mansfield Bowers**{ XE "Bowers:William Mansfield (1802–1864)" \f "Name" \b \i } in 1830.^[245] They had two children: Herman (1834–1907) and Kate (1852–1929).

William Mansfield was born in 1802.^[245] He reached 62 years of age and died on 16th April 1864.^[245]

!SPOUSE: GENEALOGICAL AND FAMILY HISTORY of SOUTHERN NEW YORK and the HUDSON RIVER VALLEY, Vol II;1640-1913; Lewis Historical Publishing Co, 1913; pp 507-510; Brewster, NY Public Library; lived in Bridgeville.

- m IX. **George E Sears**{ XE "Sears:George E (1815–1884)" \f "Name" \b } was born in perh{ XE "USA, Connecticut, Fairfield, Ridgefield, perh: :Sears, George E (1815–1884)" \f "Place" } on 3rd March 1815. He died in 1884 at the age of 68.

- f X. **Patty Maria Sears**{ XE "Sears:Patty Maria (1817–)" \f "Name" \b } was born in Sullivan, New York,{ XE "USA, New York, Sullivan:(41.7153° N, 74.765° W):Sears, Patty

²⁴³ Ancestry.com and The Church of Jesus Christ of Latter-day Saints, 1880 United States Federal Census (Provo, UT, USA, Ancestry.com Operations Inc, 2010), Ancestry.com, Year: 1880; Census Place: Gerry, Chautauqua, New York; Roll: 815; Family History Film: 1254815; Page: 385A; Enumeration District: 058; Image: 0771.

²⁴⁴ Ancestry.com, New York, State Census, 1865 (Provo, UT, USA, Ancestry.com Operations, Inc., 2014), Ancestry.com.

²⁴⁵ "Ancestry Family Tree", Record for Esther SEARS. <https://familysearch.org/ark:/61903/1:1:VQDD-36X>.

Maria (1817-) \f "Place" } on 12th March 1817.^[246] She died in Bridgeville{ XE "USA, New York, Sullivan, Bridgeville: :Sears, Patty Maria (1817-)" \f "Place" }.^[246] Patty Maria was buried in Bridgeville, Thompson{ XE "USA, New York, Sullivan, Thompson, Bridgeville: :Sears, Patty Maria (1817-)" \f "Place" }.^[246]

More facts and events for Patty Maria Sears:

Residence: 1855 Thompson{ XE "USA, New York, Sullivan, Thompson:(41.647° N, 74.6766° W):Sears, Patty Maria (1817-)" \f "Place" }.^[246]

Residence: 1st June 1875 Thompson{ XE "USA, New York, Sullivan, Thompson:(41.647° N, 74.6766° W):Sears, Patty Maria (1817-)" \f "Place" }.^[246]

Residence: 1880 Thompson{ XE "USA, New York, Sullivan, Thompson:(41.647° N, 74.6766° W):Sears, Patty Maria (1817-)" \f "Place" }.^[246]

Patty Maria married **Henry Race**{ XE "Race:Henry" \f "Name" \b \i }.

Patty Maria married **Walter Hoyt**{ XE "Hoyt:Walter (1810-1888)" \f "Name" \b \i }.^[246] They had four children: Rheua (1850-1862), Laura (1855-), Benjamin (1857-) and Gurnsey (1860-).

Walter was born in Bridgeville{ XE "USA, New York, Sullivan, Bridgeville: :Hoyt, Walter (1810-1888)" \f "Place" } on Saturday, 19th May 1810.^[246] He reached 77 years of age and died in Bridgeville{ XE "USA, New York, Sullivan, Bridgeville: :Hoyt, Walter (1810-1888)" \f "Place" } in 1888.^[246] Walter was buried in Bridgeville, Thompson{ XE "USA, New York, Sullivan, Thompson, Bridgeville: :Hoyt, Walter (1810-1888)" \f "Place" }.^[246]

!SPOUSE: GENEALOGICAL AND FAMILY HISTORY of SOUTHERN NEW YORK and the HUDSON RIVER VALLEY, Vol II;1640-1913; Lewis Historical Publishing Co, 1913; pp 507-510; Brewster, NY Public Library;

- f XI. **Mary Ann Sears**{ XE "Sears:Mary Ann (1819-1889)" \f "Name" \b } was born in perh, Ridgefield, Fairfield, Connecticut,{ XE "USA, Connecticut, Fairfield, Ridgefield, perh: :Sears, Mary Ann (1819-1889)" \f "Place" } on 18th April 1819. She died in 1889 at the age of 69.

Mary Ann married **Robert Knapp**{ XE "Knapp:Robert" \f "Name" \b \i }.

- f XII. **Caroline Ophelia Sears**{ XE "Sears:Caroline Ophelia (1824-1911)" \f "Name" \b } was born in perh{ XE "USA, Connecticut, Fairfield, Ridgefield, perh: :Sears, Caroline Ophelia (1824-1911)" \f "Place" } on 18th May 1824. She died in 1911 at the age of 86. Caroline Ophelia married **James O'Neil**{ XE "O'Neil:James" \f "Name" \b \i }.

²⁴⁶ "Ancestry Family Tree", Record for Maria Sears (Race).
<https://search.ancestry.com/cgi-bin/sse.dll?db=1030&h=202092141391&indiv=try>.

Family of Esther Sears and Jeremiah Griffiths{ TC "Esther Sears and Jeremiah Griffiths" \I 3 \f C}

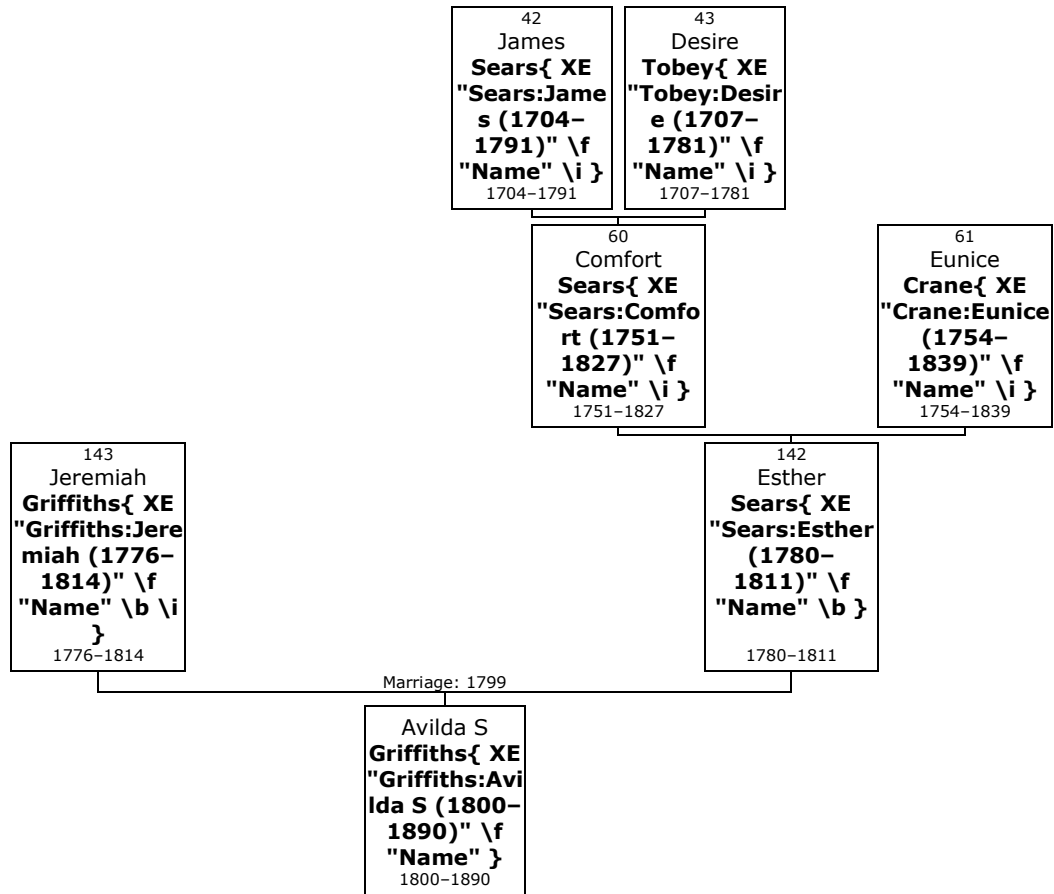

- 142.** **Esther⁴ Sears**{ XE "Sears:Esther (1780-1811)" \f "Name" \b } (*Comfort³, James²*) was born on Saturday, 29th July 1780, in Ridgefield, Fairfield, Connecticut, USA{ XE "USA, Connecticut, Fairfield, Ridgefield:(41.2815° N, 73.4982° W):Sears, Esther (1780-1811)" \f "Place" }. She was the daughter of Comfort Sears{ XE "Sears:Comfort (1751-1827)" \f "Name" \i } (60) and Eunice Crane{ XE "Crane:Eunice (1754-1839)" \f "Name" \i } (61).

Esther died on 10th October 1811, at the age of 31.

!S.P. May No 783 p.179 had 4 children

<https://www.wikitree.com/wiki/Sears-4786>

- 143.** Esther married **Jeremiah Griffiths**{ XE "Griffiths:Jeremiah (1776-1814)" \f "Name" \b \i } in 1799. They had one daughter: Avilda (1800-1890).

Jeremiah was born in perh, Ridgefield,{ XE "USA, Connecticut, Fairfield, Ridgefield, perh: :Griffiths, Jeremiah (1776-1814)" \f "Place" } in 1776. He reached 38 years of age and died in 1814.

!S.P. May p.179 Had 4 children

Daughter of Esther Sears and Jeremiah Griffiths:

f I. **Avilda S⁵ Griffiths**{ XE "Griffiths:Avilda S (1800–1890)" \f "Name" \b } was born in Ridgefield{ XE "USA, Connecticut, Fairfield, Ridgefield:(41.2815° N, 73.4982° W):Griffiths, Avilda S (1800–1890)" \f "Place" } on 20th June 1800.^[247, 248, 249–250] She died in Zumbrota{ XE "USA, Minnesota, Goodhue, Zumbrota:(44.2941° N, 92.6691° W):Griffiths, Avilda S (1800–1890)" \f "Place" } on 20th November 1890, at the age of 90.^[248, 250] Avilda S was buried in Zumbrota, Goodhue County{ XE "USA, Minnesota, Goodhue County, Zumbrota:(44.2941° N, 92.6691° W):Griffiths, Avilda S (1800–1890)" \f "Place" }.^[248]



Avilda

More facts and events for Avilda S Griffiths:

Residence: 1880

Zumbrota, Goodhue{ XE "USA, Minnesota, Goodhue, Zumbrota:(44.2941° N, 92.6691° W):Griffiths, Avilda S (1800–1890)" \f "Place" }.^[249]

Marital Status: Widowed; Relation to Head of House: Self

Residence: 1st May 1885

Zumbrota{ XE "USA, Minnesota, Goodhue, Zumbrota:(44.2941° N, 92.6691° W):Griffiths, Avilda S (1800–1890)" \f "Place" }.^[247]

Avilda S married **Amos Scofield**{ XE "Scofield:Amos (1796–1844)" \f "Name" \b \i }.^[248] They had eight children: James (1824–1901), Anne (1826–1909), Francis (1829–1905), Mary (1835–1861), Persis (1843–1923), David, George and Amos.

Amos was born on Friday, 29th April 1796.^[248]

He reached 47 years of age and died in 1844.^[248] Amos was buried in Greenwood, McHenry, Illinois{ XE "USA, Illinois, McHenry, Greenwood:(42.3925° N, 88.3893° W):Scofield, Amos (1796–1844)" \f "Place" }.^[248]

²⁴⁷ Ancestry.com, Minnesota, Territorial and State Censuses, 1849-1905 (Provo, UT, USA, Ancestry.com Operations Inc, 2007), Ancestry.com.

²⁴⁸ Ancestry.com, U.S., Find A Grave Index, 1600s-Current (Provo, UT, USA, Ancestry.com Operations, Inc., 2012), Ancestry.com.

²⁴⁹ Ancestry.com and The Church of Jesus Christ of Latter-day Saints, 1880 United States Federal Census (Provo, UT, USA, Ancestry.com Operations Inc, 2010), Ancestry.com, Year: 1880; Census Place: Zumbrota, Goodhue, Minnesota; Roll: 621; Family History Film: 1254621; Page: 367C; Enumeration District: 165; Image: 0289.

²⁵⁰ Dalby, John, Minnesota Cemetery Inscription Index, Select Counties (Provo, UT, USA, Ancestry.com Operations Inc, 2003), Ancestry.com.

Family of Desire Sears and Czar Benedict{ TC "Desire Sears and Czar Benedict" \i 3 \f C}

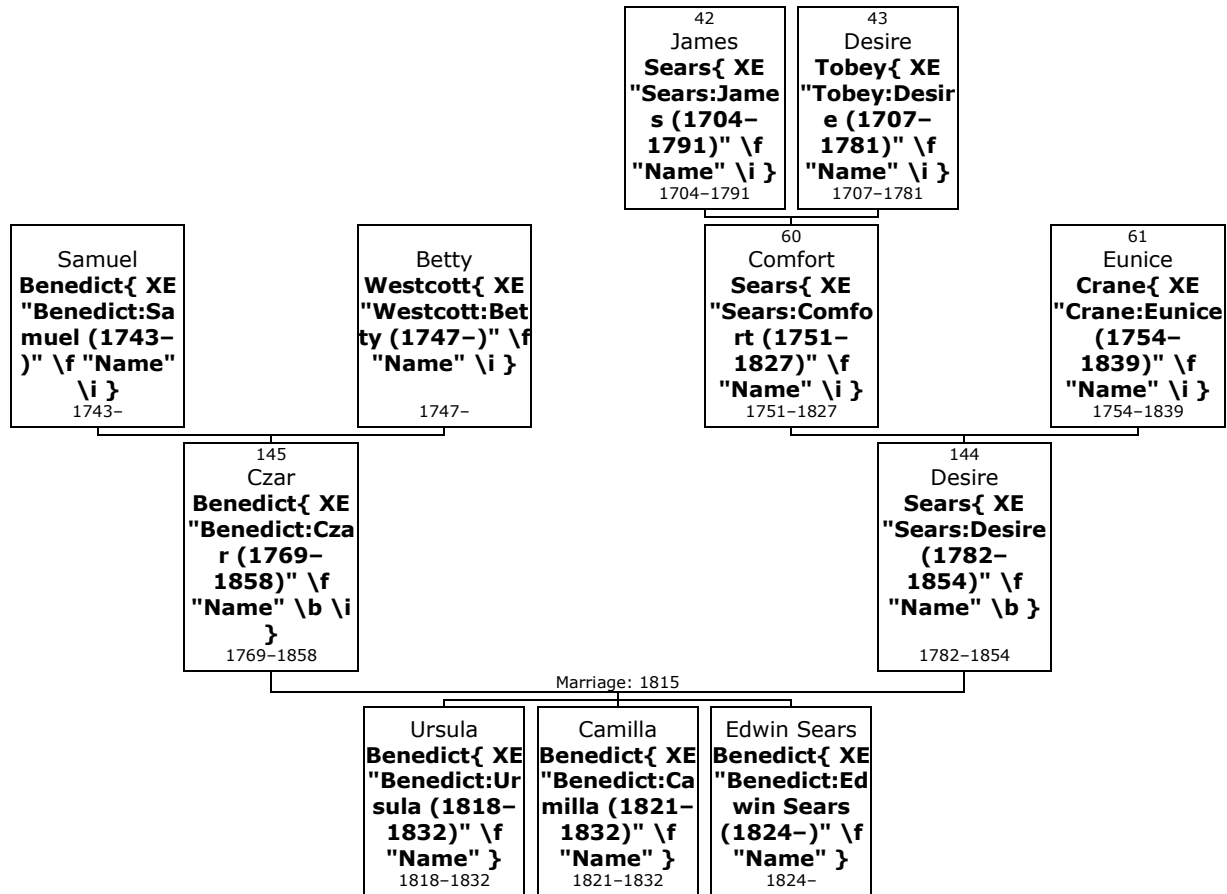

- 144.** **Desire⁴ Sears**{ XE "Sears:Desire (1782–1854)" \f "Name" \b } (*Comfort³, James²*) was born on Friday, 24th May 1782, in Ridgefield, Fairfield, Connecticut, USA{ XE "USA, Connecticut, Fairfield, Ridgefield:(41.2815° N, 73.4982° W):Sears, Desire (1782–1854)" \f "Place" }. She was the daughter of Comfort Sears{ XE "Sears:Comfort (1751–1827)" \f "Name" \i } (60) and Eunice Crane{ XE "Crane:Eunice (1754–1839)" \f "Name" \i } (61).

Desire died on 22nd April 1854, at the age of 71.

<https://www.wikitree.com/wiki/Sears-4787>

- 145.** At the age of 33, Desire married **Czar Benedict**{ XE "Benedict:Czar (1769–1858)" \f "Name" \b \i } on Sunday, 1st October 1815, when he was 46 years old. They had three children: Ursula (1818–1832), Camilla (1821–1832) and Edwin (1824–).

Czar was born in perh, Lebanon, New London,{ XE "USA, Connecticut, New London, Lebanon, perh: :Benedict, Czar (1769–1858)" \f "Place" } on Saturday, 7th January 1769. He was the son of Samuel Benedict{ XE "Benedict:Samuel (1743–)" \f "Name" \i } and Betty Westcott{ XE "Westcott:Betty (1747–)" \f "Name" \i }.

Czar reached 89 years of age and died in Lebanon{ XE "USA, Connecticut, New London, Lebanon:(41.6361° N, 72.2131° W):Benedict, Czar (1769–1858)" \f "Place" } on 5th December 1858.

!S.P. May p.179 hand note 1st wife unknown

Children of Desire Sears and Czar Benedict:

- f I. **Ursula⁵ Benedict**{ XE "Benedict:Ursula (1818–1832)" \f "Name" \b } was born in perh, Ridgefield, Fairfield,{ XE "USA, Connecticut, Fairfield, Ridgefield, perh: :Benedict, Ursula (1818–1832)" \f "Place" } on 7th July 1818. She died on 9th July 1832, at the age of 14.
- f II. **Camilla Benedict**{ XE "Benedict:Camilla (1821–1832)" \f "Name" \b } was born in perh{ XE "USA, Connecticut, Fairfield, Ridgefield, perh: :Benedict, Camilla (1821–1832)" \f "Place" } on 30th July 1821. She died on 27th July 1832, at the age of 10.

m III. **Edwin Sears Benedict**{ XE "Benedict:Edwin Sears (1824-)" \f "Name" \b } was born in perh{ XE "USA, Connecticut, Fairfield, Ridgefield, perh: :Benedict, Edwin Sears (1824-)" \f "Place" } on 14th July 1824.

Edwin Sears married **Caroline Aurelia Benedict**{ XE "Benedict:Caroline Aurelia" \f "Name" \b \i } on Tuesday, 15th September 1846. They had one son: Frank (1848-). She was the daughter of Stephen Benedict{ XE "Benedict:Stephen" \f "Name" \i }.

Benedict book says Caroline Amelia

Family of Eunice Sears and James Weed{ TC "Eunice Sears and James Weed" \I 3 \f C}

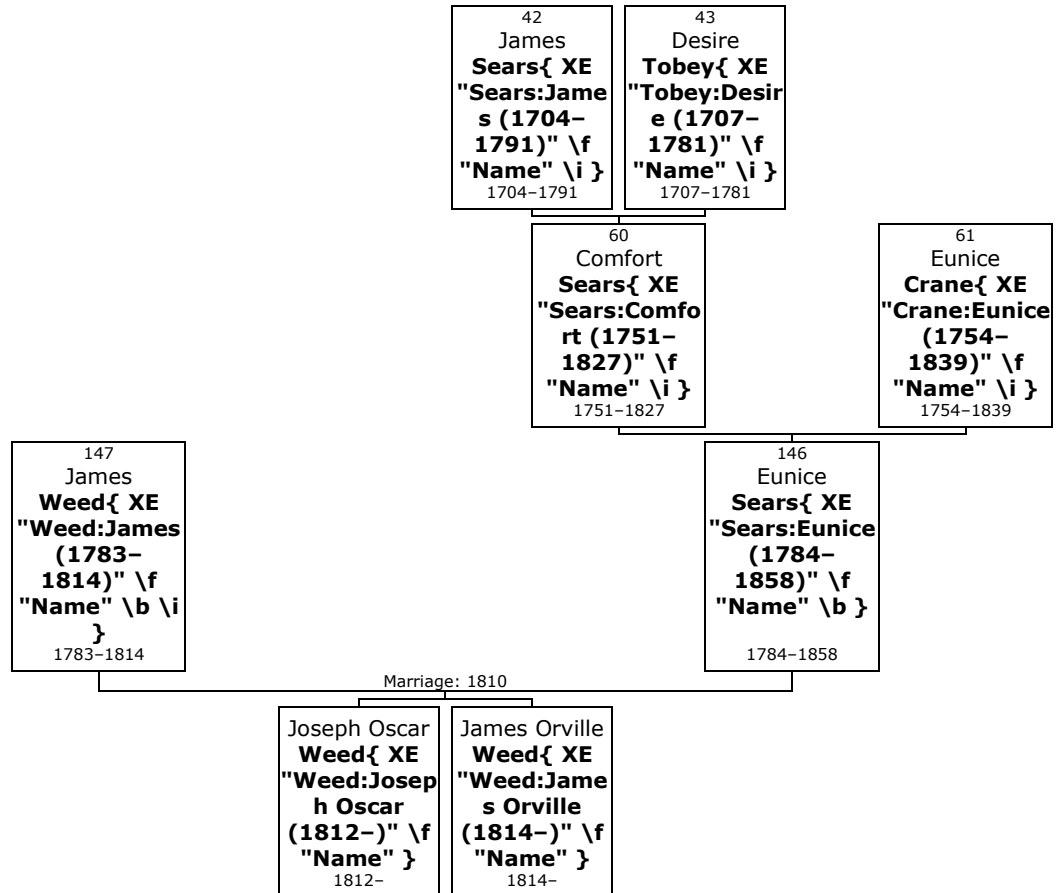

146. Eunice⁴ Sears{ XE "Sears:Eunice (1784-1858)" \f "Name" \b } (*Comfort³, James²*) was born on Wednesday, 4th February 1784, in Ridgefield, Fairfield, Connecticut, USA{ XE "USA, Connecticut, Fairfield, Ridgefield:(41.2815° N, 73.4982° W):Sears, Eunice (1784-1858)" \f "Place" }. She was the daughter of Comfort Sears{ XE "Sears:Comfort (1751-1827)" \f "Name" \i } (60) and Eunice Crane{ XE "Crane:Eunice (1754-1839)" \f "Name" \i } (61).

Eunice died on 8th July 1858, at the age of 74. She was buried in Milltown Cemetery, Southeast, Putnam, New York{ XE "USA, New York, Putnam, Southeast, Milltown Cemetery: :Sears, Eunice (1784-1858)" \f "Place" }.

[MB]-BUR.- Milltown Cem, Putnam co, NY

<https://www.wikitree.com/wiki/Sears-4788>

147. At the age of 26, Eunice married **James Weed**{ XE "Weed:James (1783-1814)" \f "Name" \b \i } on Tuesday, 18th December 1810, when he was 27 years old. They had two sons: Joseph (1812-) and James (1814-).

James was born in perh, Ridgefield, Fairfield, Connecticut,{ XE "USA, Connecticut, Fairfield, Ridgefield, perh: :Weed, James (1783-1814)" \f "Place" } on Monday, 31st March 1783. He reached 31 years of age and died on 8th May 1814.

!S.P. May p.179 James died of the malignant fever that raged in So. E. that spring.

Sons of Eunice Sears and James Weed:

- m I. **Joseph Oscar⁵ Weed**{ XE "Weed:Joseph Oscar (1812-)" \f "Name" \b } was born in perh{ XE "USA, Connecticut, Fairfield, Ridgefield, perh: :Weed, Joseph Oscar (1812-)" \f "Place" } on 4th December 1812.

At the age of 24, Joseph Oscar married **Ann Eliza Eliza Quintard**{ XE "Quintard:Ann Eliza \"Eliza\" (1818-)" \f "Name" \b \i } on Monday, 6th November 1837, when she was 19 years old. They had two children: George (1839-) and Mary (1842-1890).

Eliza was born in Norwalk{ XE "USA, Connecticut, Fairfield, Norwalk:(41.1176° N, 73.4079° W):Quintard, Ann Eliza \"Eliza\" (1818-)" \f "Place" } on Friday, 23rd October 1818.

- m II. **James Orville Weed**{ XE "Weed:James Orville (1814-)" \f "Name" \b } was born in perh{ XE "USA, Connecticut, Fairfield, Ridgefield, perh: :Weed, James Orville (1814-)" \f "Place" } on 4th September 1814.

At the age of 28, James Orville Weed married **Sarah E Crane**{ XE "Crane:Sarah E (1818-)" \f "Name" \b \i } on Wednesday, 12th April 1843, when she was 24 years old. They had no known children.

Sarah E was born in Southeast, Putnam, New York,{ XE "USA, New York, Putnam, Southeast:(41.4054° N, 73.6001° W):Crane, Sarah E (1818-)" \f "Place" } on Friday, 23rd October 1818.

Family of Camilla Sears and Elijah Crosby{ TC "Camilla Sears and Elijah Crosby" \I 3 \f C}

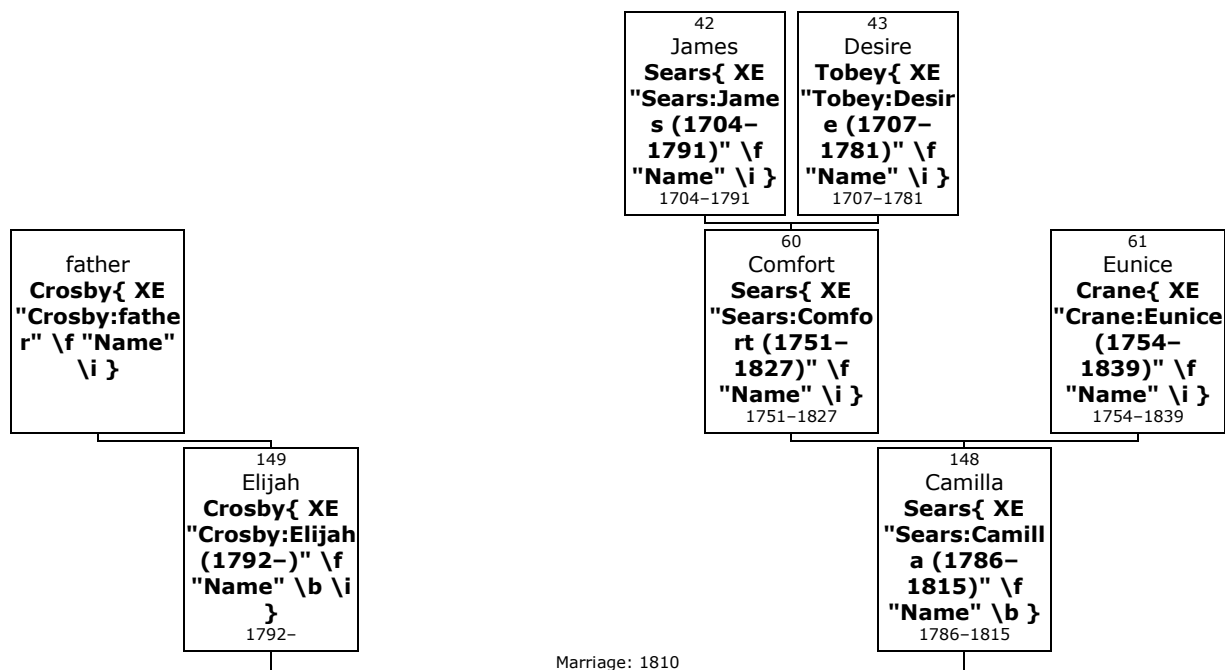

- 148. Camilla⁴ Sears**{ XE "Sears:Camilla (1786-1815)" \f "Name" \b } (*Comfort³, James²*) was born on Wednesday, 26th April 1786, in perh, Ridgefield, Fairfield, Connecticut, USA{ XE "USA, Connecticut, Fairfield, Ridgefield, perh: :Sears, Camilla (1786-1815)" \f "Place" }. She was the daughter of Comfort Sears{ XE "Sears:Comfort (1751-1827)" \f "Name" \i } (60) and Eunice Crane{ XE "Crane:Eunice (1754-1839)" \f "Name" \i } (61).

Camilla died on 9th January 1815, at the age of 28.

!S.P.May No 786 p.179 Had 2 chil.

<https://www.wikitree.com/wiki/Sears-4789>

- 149.** Camilla married **Elijah Crosby**{ XE "Crosby:Elijah (1792-)" \f "Name" \b \i } on Wednesday, 4th July 1810. They had no known children.

Elijah was born in perh, Southeast, Putnam, New York,{ XE "USA, New York, Putnam, Southeast, perh: Crosby, Elijah (1792-)" \f "Place" } in 1792. He was the son of father Crosby{ XE "Crosby:father" \f "Name" \i }.

James Sears{ TC "James Sears" \I 3 \f C}

150. Dea. James⁴ Sears{ XE "Sears:James (1788-1878)" \f "Name" \b } (*Comfort³, James²*) was born on Monday, 10th November 1788, in Ridgefield, Fairfield, Connecticut, USA{ XE "USA, Connecticut, Fairfield, Ridgefield:(41.2815° N, 73.4982° W):Sears, James (1788-1878)" \f "Place" }.^[251] He was the son of Comfort Sears{ XE "Sears:Comfort (1751-1827)" \f "Name" \i } (60) and Eunice Crane{ XE "Crane:Eunice (1754-1839)" \f "Name" \i } (61).

James died in Seneca Castle, Ontario, New York,{ XE "USA, New York, Ontario, Seneca Castle:(42.8869° N, 77.0964° W):Sears, James (1788-1878)" \f "Place" } on 19th January 1878, at the age of 89.^[251] He was buried in Seneca, Ontario County{ XE "USA, New York, Ontario County, Seneca:(42.8367° N, 77.0756° W):Sears, James (1788-1878)" \f "Place" }.^[251]

!S.P. May p.282 James Sears removed from Millplain, CT to Seneca Castle, NY in 1836, having sold his farm (which adjoined his bro. Lewis', and was 2 miles from the old homestead,) to his bro. Joseph C. He was a well-to-do farmer, of excellent literary taste, and of much spiritual culture. His idea of honesty was, good measure, pressed down and running over, and every thing was done heartily, and as unto the Lord, who seemed ever present with him. He was single-hearted, pure-minded beyond most Christians, and had great humility. All his children were taught by example as well as precept. He was a Deacon for 30 years, and was blessed with two most excellent wives.

<https://www.wikitree.com/wiki/Sears-4790>

<https://www.findagrave.com/memorial/115562689>

Marriages with Charity White and Deborah Crosby (Page 180) are known.

Family of James Sears and Charity White{ TC "James Sears and Charity White" \I 4 \f C}

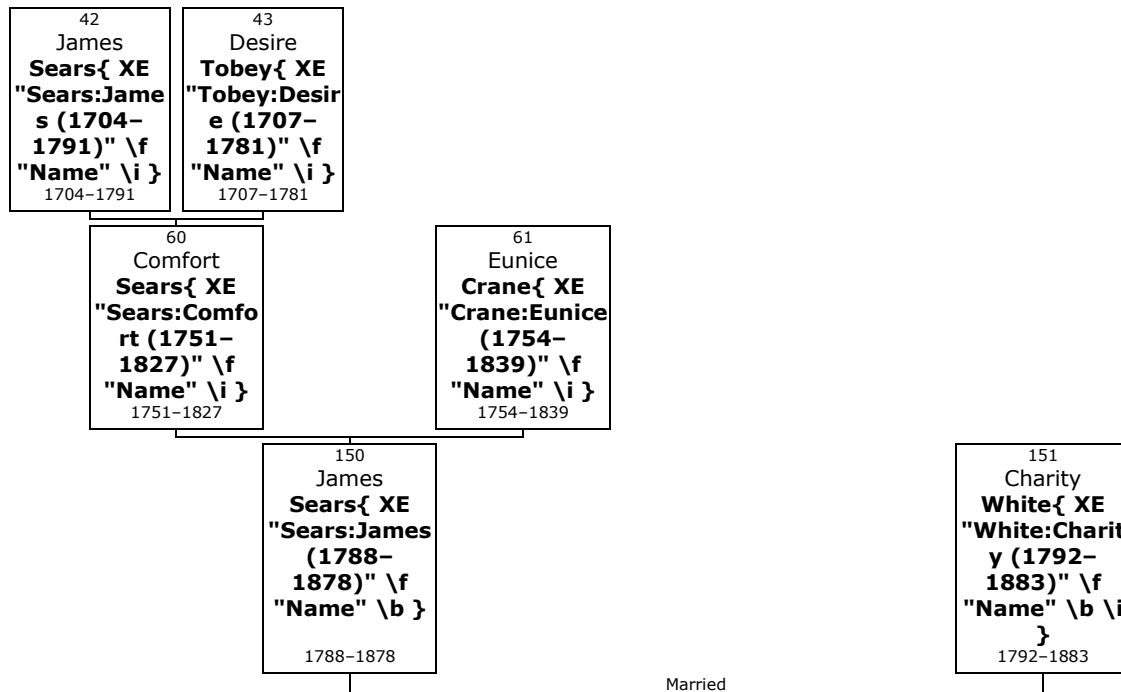

Here are the details about **James Sears**{ XE "Sears:James (1788-1878)" \f "Name" \b } first marriage, with Charity White. You can read more about James on page 179.

151. Dea. James Sears married **Charity White**{ XE "White:Charity (1792-1883)" \f "Name" \b \i }. They had no known children.

²⁵¹ Ancestry.com, U.S., Find A Grave Index, 1600s-Current (Provo, UT, USA, Ancestry.com Operations, Inc., 2012), Ancestry.com, <https://www.findagrave.com/memorial/115562689>.

Charity was born in perh, Ridgefield,{ XE "USA, Connecticut, Fairfield, Ridgefield, perh: :White, Charity (1792-1883)" \f "Place" } in 1792. She reached 91 years of age and died on 11th April 1883.

!S.P. May Having been thrice married

Family of James Sears and Deborah Crosby{ TC "James Sears and Deborah Crosby" \I 4 \f C}

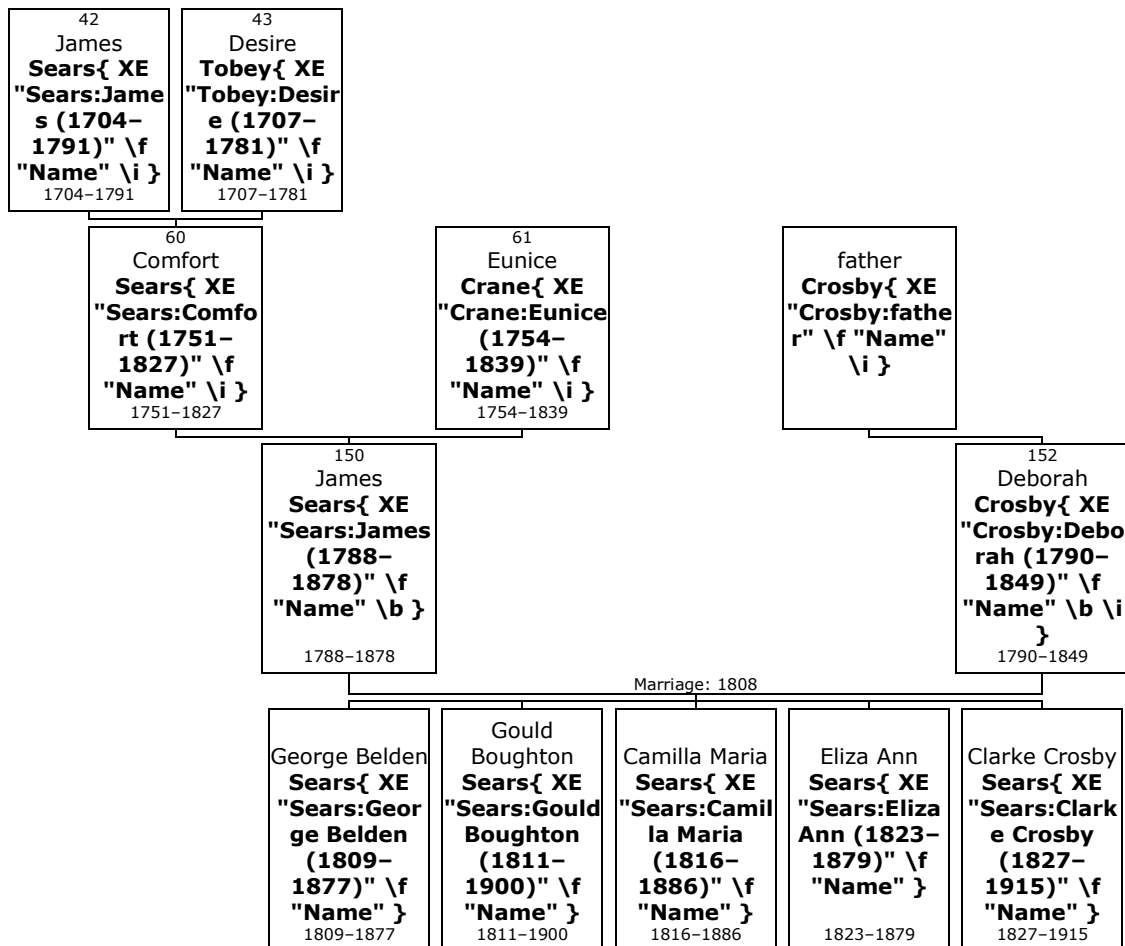

Here are the details about **James Sears**{ XE "Sears:James (1788-1878)" \f "Name" \b } second marriage, with Deborah Crosby. You can read more about James on page 179.

- 152.** At the age of 19, Dea. James Sears married **Deborah Crosby**{ XE "Crosby:Deborah (1790-1849)" \f "Name" \b \i } on Tuesday, 11th October 1808, in Southeast, Putnam, New York,{ XE "USA, New York, Putnam, Southeast:(41.4054° N, 73.6001° W):Sears, James (1788-1878)" \f "Place" } when she was 18 years old. They had five children: George (1809-1877), Gould (1811-1900), Camilla (1816-1886), Eliza (1823-1879) and Clarke (1827-1915).

Deborah was born in was Dutchess, Southeast,{ XE "USA, New York, Putnam, Southeast, was Dutchess: :Crosby, Deborah (1790-1849)" \f "Place" } on Monday, 11th October 1790. She was the daughter of father Crosby{ XE "Crosby:father" \f "Name" \i }.

Deborah reached 58 years of age and died in Phelps, Ontario,{ XE "USA, New York, Ontario, Phelps:(42.9576° N, 77.0575° W):Crosby, Deborah (1790-1849)" \f "Place" } on 3rd February 1849.

Children of James Sears and Deborah Crosby:

- m I. **George Belden⁵ Sears**{ XE "Sears:George Belden (1809-1877)" \f "Name" \b } was born in Mill Plain, Fairfield, Fairfield, Connecticut,{ XE "USA, Connecticut, Fairfield, Fairfield, Mill Plain: :Sears, George Belden (1809-1877)" \f "Place" } on 25th June 1809.^[252, 253, 254, 255, 256, 257, 258-259] He died in Newark{ XE "USA, New Jersey, Essex,

²⁵² Ancestry.com, New Jersey, Deaths and Burials Index, 1798-1971 (Provo, UT, USA, Ancestry.com Operations, Inc., 2011), Ancestry.com.

Newark:(40.7357° N, 74.1724° W):Sears, George Belden (1809–1877)" \f "Place" } on 17th November 1877, at the age of 68.^[252, 253, 255, 257, 258] George Belden was buried in Newark, Essex County{ XE "USA, New Jersey, Essex County, Newark:(40.7357° N, 74.1724° W):Sears, George Belden (1809–1877)" \f "Place" },^[253] His estate was probated on 25th October 1878, in Essex{ XE "USA, New Jersey, Essex:(40.7873° N, 74.2463° W):Sears, George Belden (1809–1877)" \f "Place" }.^[258]

More facts and events for George Belden Sears:

Residence: 1870 Newark, Essex{ XE "USA, New Jersey, Essex, Newark:(40.7357° N, 74.1724° W):Sears, George Belden (1809–1877)" \f "Place" }^[254]
Residence Post Office: Newark/Ward 3

At the age of 20, George Belden married **Marinda B Rockwell**{ XE "Rockwell:Marinda B (1813–1831)" \f "Name" \b \i } on Tuesday, 15th September 1829, in Ridgefield, Fairfield, Connecticut,{ XE "USA, Connecticut, Fairfield, Ridgefield:(41.2815° N, 73.4982° W):Sears, George Belden (1809–1877)" \f "Place" } when she was 16 years old.^[253, 259, 260] They had no known children.

Marinda B was born in Ridgefield{ XE "USA, Connecticut, Fairfield, Ridgefield:(41.2815° N, 73.4982° W):Rockwell, Marinda B (1813–1831)" \f "Place" } on Tuesday, 12th January 1813.^[259, 260] She reached 18 years of age and died in Ridgefield{ XE "USA, Connecticut, Fairfield, Ridgefield:(41.2815° N, 73.4982° W):Rockwell, Marinda B (1813–1831)" \f "Place" } on 25th July 1831.^[253, 259, 260] Marinda B was buried in Ridgefield{ XE "USA, Connecticut, Fairfield, Ridgefield:(41.2815° N, 73.4982° W):Rockwell, Marinda B (1813–1831)" \f "Place" }.^[253]

At the age of 22, George Belden Sears married **Mary Jane Northrop**{ XE "Northrop:Mary Jane (1813–)" \f "Name" \b \i } on Wednesday, 28th March 1832, when she was 18 years old.^[254, 256, 261, 262–263] They had four daughters: Augusta (1834–), Ann (1836–1841), Anna (1842–1880) and Mary (1851–).

-
- ²⁵³ Ancestry.com, U.S., Find A Grave Index, 1600s-Current (Provo, UT, USA, Ancestry.com Operations, Inc., 2012), Ancestry.com.
- ²⁵⁴ Ancestry.com, 1870 United States Federal Census (Provo, UT, USA, Ancestry.com Operations, Inc., 2009), Ancestry.com, Year: 1870; Census Place: Newark Ward 3, Essex, New Jersey; Roll: M593_879; Page: 272A; Family History Library Film: 552378.
- ²⁵⁵ Ancestry.com, U.S., Newspaper Extractions from the Northeast, 1704-1930 (Provo, UT, USA, Ancestry.com Operations, Inc., 2014), Ancestry.com.
- ²⁵⁶ Ancestry.com, North America, Family Histories, 1500-2000 (Provo, UT, USA, Ancestry.com Operations, Inc., 2016), Ancestry.com, Book Title: The Northrup-Northrop genealogy : a record of the known descendants of Joseph Northrup, who came fr.
- ²⁵⁷ Ancestry.com, Web: Warren County, New Jersey, Obituary Index, 1848-1914 (Provo, UT, USA, Ancestry.com Operations, Inc., 2012), Ancestry.com.
- ²⁵⁸ Ancestry.com, New Jersey, Wills and Probate Records, 1739-1991 (Provo, UT, USA, Ancestry.com Operations, Inc., 2015), Ancestry.com, Author: New Jersey. Surrogate's Court (Essex); Probate Place: Essex, New Jersey.
- ²⁵⁹ Ancestry.com, Connecticut, Hale Cemetery Inscriptions and Newspaper Notices, 1629-1934 (Provo, UT, USA, Ancestry.com Operations, Inc., 2012), Ancestry.com, Connecticut State Library; Hartford, Connecticut.
- ²⁶⁰ Ancestry.com, Connecticut, Deaths and Burials Index, 1650-1934 (Provo, UT, USA, Ancestry.com Operations, Inc., 2011), Ancestry.com.
- ²⁶¹ Ancestry.com and The Church of Jesus Christ of Latter-day Saints, 1880 United States Federal Census (Provo, UT, USA, Ancestry.com Operations Inc, 2010), Ancestry.com, Year: 1880; Census Place: Newark, Essex, New Jersey; Roll: 776; Page: 241D; Enumeration District: 031.
[Source citation includes one media item]
- ²⁶² Ancestry.com, 1860 United States Federal Census (Provo, UT, USA, Ancestry.com Operations, Inc., 2009), Ancestry.com, Year: 1860; Census Place: Newark Ward 3, Essex, New Jersey; Roll: M653_688; Page: 299; Family History Library Film: 803688.
[Source citation includes one media item]
- ²⁶³ Ancestry.com, 1850 United States Federal Census (Provo, UT, USA, Ancestry.com Operations, Inc., 2009), Ancestry.com, Year: 1850; Census Place: Newark South Ward, Essex, New Jersey; Roll: M432_447; Page: 219A; Image: 449.
[Source citation includes one media item]

Mary Jane was born in Southeast, Putnam, New York, { XE "USA, New York, Putnam, Southeast:(41.4054° N, 73.6001° W):Northrop, Mary Jane (1813-)" \f "Place" } on Sunday, 18th July 1813.^[254, 256, 261-263] She was the daughter of James Northrop { XE "Northrop:James" \f "Name" \i } and Susan --Northrop { XE "--Northrop:Susan" \f "Name" \i }.

!CL3RD Jul 29 2013 5:20 PM GMT I am hoping that you might provide access to your information regarding Mary Jane Northrop Sears. I am new to ancestry.com, so let me know if you would like any additional information. Thanks, Cloyd.

!Ancestor link: Mary Jane Northrop (1813 -) CL3RD 8 Aug 2013 2:42 PM GMT Really returned to the area. Sears is on my mother's father's side, George Packer Berry. My great uncle was Richard Sears Berry, who lived in NYC. My mother's mother died shortly after my mother's birth, and she ended up being raised in Rochester before going to boarding school and then Smith College (where she met my father). It is my father who has the close connection to this area, so my growing up here is a coincidence.

!

!1880 United States Federal Census about Mary J. Sears Name: Mary J. Sears Age: 66 Birth Year: abt 1814 Birthplace: New York Home in 1880: Newark, Essex, New Jersey Race: White Gender: Female Relation to Head of House: Mother-in-law Marital Status: Widowed Father's Birthplace: New York Mother's Birthplace: New York Neighbors: View others on page Cannot read/write: Blind: Deaf and dumb: Otherwise disabled: Idiotic or insane: View Image Household Members: Name Age J.J. Dickerson 50 Augusta M. Dickerson 45 Mary J. Sears 66 Sophia Beckett 45 Fitzimmons 28 Eliza B. Winans 55

!1880 United States Federal Census

<http://www.ancestry.com/search/db.aspx?dbid=6742> Name: Mary J. Sears Age: 66 Birth Year: abt 1814 Birthplace: New York Home in 1880: Newark, Essex, New Jersey Race: White Gender: Female Relation to Head of House: Mother-in-law Marital Status: Widowed Father's Birthplace: New York Mother's Birthplace: New York Household Members: Name Age

J.J. Dickerson 50

Augusta M. Dickerson 45

Mary J. Sears 66

Sophia Beckett 45

Fitzimmons 28

Eliza B. Winans 55

CL3RD Jul 29 5:20 PM GMT I am hoping that you might provide access to your information regarding Mary Jane Northrop Sears. I am new to ancestry.com, so let me know if you would like any additional information. Thanks, Cloyd. Ancestor link: Mary Jane Northrop (1813 -) CL3RD 8 Aug 2013 2:42 PM GMT Really returned to the area. Sears is on my mother's father's side, George Packer Berry. My great uncle was Richard Sears Berry, who lived in NYC. My mother's mother died shortly after my mother's birth, and she ended up being raised in Rochester before going to boarding school and then Smith College (where she met my father). It is my father who has the close connection to this area, so my growing up here is a coincidence.

1870 United States Federal Census about Mary Northrop Name: Mary Northrop Age in 1870: 57 Birth Year: abt 1813 Birthplace: New York Home in 1870: Bridgeport, Fairfield, Connecticut Race: White Gender: Female Post Office: Bridgeport Value of real estate: View Image Household Members: Name Age Mary Northrop 57 William Northrop 29 Marhta Kimball 25 John R Kimball 26 Lottie Kimball 1 Elizabeth Northrop 24 William Northrop 3 Benjamin Northrop 7/12 Clarissa Northrop 20 Lydia M Morton 26 Hattie Kimball 23 Charles N Whitherell 23

1880 United States Federal Census about Mary J. Sears Name: Mary J. Sears Age: 66 Birth Year: abt 1814 Birthplace: New York Home in 1880: Newark, Essex, New Jersey Race: White Gender: Female Relation to Head of House: Mother-in-law Marital Status: Widowed Father's Birthplace: New York Mother's Birthplace: New York Neighbors: View others on page Cannot read/write: Blind: Deaf and dumb: Otherwise disabled: Idiotic or insane: View Image Household Members: Name Age J.J. Dickerson 50 Augusta M. Dickerson 45 Mary J. Sears 66 Sophia Beckett 45 Fitzimmons 28 Eliza B. Winans 55

!CL3RD Jul 29 2013 5:20 PM GMT I am hoping that you might provide access to your information regarding Mary Jane Northrop Sears. I am new to ancestry.com, so let me know if you would like any additional information. Thanks, Cloyd. Ancestor link: Mary Jane Northrop (1813 -) CL3RD 8 Aug 2013 2:42 PM GMT Really returned to the area. Sears is on my mother's father's side, George Packer Berry. My great uncle was Richard Sears Berry, who lived in NYC. My mother's mother died shortly after my mother's birth, and she ended up being raised in Rochester before going to boarding school and then Smith College (where she met my father). It is my father who has the close connection to this area, so my growing up here is a coincidence.

!

!1870 United States Federal Census

<http://www.ancestry.com/search/db.aspx?dbid=7163> Name: Mary Northrop
Age in 1870: 57 Birth Year: abt 1813 Birthplace: New York Home in 1870: Bridgeport,
Fairfield, Connecticut Race: White Gender: Female Post Office: Bridgeport
Household Members: Name Age

Mary Northrop 57
William Northrop 29
Marhta Kimball 25
John R Kimball 26
Lottie Kimball 1
Elizabeth Northrop 24
William Northrop 3
Benjamin Northrop 7/12
Clarissa Northrop 20
Lydia M Morton 26
Hattie Kimball 23
Charles N Whitherell 23

!

!1880 United States Federal Census

<http://www.ancestry.com/search/db.aspx?dbid=6742> Name: Mary J. Sears
Age: 66 Birth Year: abt 1814 Birthplace: New York Home in 1880: Newark, Essex, New
Jersey Race: White Gender: Female Relation to Head of House: Mother-in-law Marital
Status: Widowed Father's Birthplace: New York Mother's Birthplace: New York
Household Members: Name Age

J.J. Dickerson 50
Augusta M. Dickerson 45
Mary J. Sears 66
Sophia Beckett 45
Fitzimmons 28
Eliza B. Winans 55

- m II. **Gould Boughton Sears**{ XE "Sears:Gould Boughton (1811–1900)" \f "Name" \b } was born in Millplain{ XE "USA, Connecticut, Millplain: :Sears, Gould Boughton (1811–1900)" \f "Place" } on 18th April 1811.^[264, 265, 266–267] He died in Quincy, Branch, Michigan,{ XE "USA, Michigan, Branch, Quincy:(41.9442° N, 84.8839° W):Sears, Gould Boughton (1811–1900)" \f "Place" } on 19th April 1900, at the age of 89.^[265]

More facts and events for Gould Boughton Sears:

Residence: 1855 Seneca, Ontario, New York{ XE "USA, New York, Ontario, Seneca:(42.8367° N, 77.0756° W):Sears, Gould Boughton (1811–1900)" \f "Place" }^[266]
Relation to Head: Head

Residence: 1865 Seneca{ XE "USA, New York, Ontario, Seneca:(42.8367° N, 77.0756° W):Sears, Gould Boughton (1811–1900)" \f

²⁶⁴ Ancestry.com, New York, State Census, 1865 (Provo, UT, USA, Ancestry.com Operations, Inc., 2014), Ancestry.com.

²⁶⁵ Ancestry.com, Michigan, Death Records, 1897-1920 (Provo, UT, USA, Ancestry.com Operations, Inc., 2010), Ancestry.com, The Library of Michigan; Michigan Death Records, 1897-1920; Rolls: 1-302; Archive Barcode/Item Number: 30000008346003; Roll Number: 24; Certificate Number: 1.

²⁶⁶ Ancestry.com, New York, State Census, 1855 (Provo, UT, USA, Ancestry.com Operations, Inc., 2013), Ancestry.com.

²⁶⁷ Ancestry.com, Michigan, Death Records, 1867-1950 (Provo, UT, USA, Ancestry.com Operations, Inc., 2015), Ancestry.com.

"Place" }^[264]

Relation to Head of House: Head

At the age of 23, Gould Boughton Sears married **Betsy Ann Sanford**{ XE "Sanford:Betsy Ann (1816-1889)" \f "Name" \b \i } on Tuesday, 21st October 1834, in Redding, Fairfield, Connecticut,{ XE "USA, Connecticut, Fairfield, Redding:(41.3025° N, 73.3839° W):Sears, Gould Boughton (1811-1900)" \f "Place" } when she was 18 years old.^[264, 266, 267] They had three children: James (1836-1897), Dewitt (1838-1923) and Annette (1847-1926).

Betsy Ann was born in Redding{ XE "USA, Connecticut, Fairfield, Redding:(41.3025° N, 73.3839° W):Sanford, Betsy Ann (1816-1889)" \f "Place" } on Monday, 22nd January 1816.^[264, 266, 267] She was the daughter of Seth Sanford{ XE "Sanford:Seth" \f "Name" \i } and Esther --Sanford{ XE "--Sanford:Esther" \f "Name" \i }.

Betsy Ann reached 73 years of age and died in Quincy, Branch, Michigan,{ XE "USA, Michigan, Branch, Quincy:(41.9442° N, 84.8839° W):Sanford, Betsy Ann (1816-1889)" \f "Place" } on 3rd December 1889.^[267]

- f III. **Camilla Maria Sears**{ XE "Sears:Camilla Maria (1816-1886)" \f "Name" \b } was born in Millplain{ XE "USA, Connecticut, Millplain: :Sears, Camilla Maria (1816-1886)" \f "Place" } on 9th August 1816. She died in 1886 at the age of 69.

At the age of 17, Camilla Maria Sears married **Francis B Northrop**{ XE "Northrop:Francis B (1809-)" \f "Name" \b \i } on Wednesday, 25th December 1833, in Ridgefield, Fairfield,{ XE "USA, Connecticut, Fairfield, Ridgefield:(41.2815° N, 73.4982° W):Sears, Camilla Maria (1816-1886)" \f "Place" } when he was 24 years old. They had four children: Marietta (1834-), James (1840-), Henry (1843-) and George (1850-).

Francis B was born in North Salem, Westchester, New York,{ XE "USA, New York, Westchester, North Salem:(41.3347° N, 73.5717° W):Northrop, Francis B (1809-)" \f "Place" } on Monday, 1st May 1809. He was the son of James Northrop{ XE "Northrop:James (1783-)" \f "Name" \i } and Susan Frances Smith{ XE "Smith:Susan Frances (1785-1849)" \f "Name" \i }.

- f IV. **Eliza Ann Sears**{ XE "Sears:Eliza Ann (1823-1879)" \f "Name" \b } was born in Mill Plain, Fairfield,{ XE "USA, Connecticut, Fairfield, Fairfield, Mill Plain: :Sears, Eliza Ann (1823-1879)" \f "Place" } on 13th May 1823. She died in August 1879 at the age of 56.

Eliza Ann Sears married **John Wright**{ XE "Wright:John (1819-)" \f "Name" \b \i } in March 1840. They had two children: W (1841-) and (unknown given name) (1843-).

John was born in 1819.

- m V. **Clarke Crosby Sears**{ XE "Sears:Clarke Crosby (1827-1915)" \f "Name" \b } was born in Millplain{ XE "USA, Connecticut, Millplain: :Sears, Clarke Crosby (1827-1915)" \f "Place" } on 23rd October 1827.^[253, 267, 268-269] He died in 1915 at the age of 87.^[253]

Clarke Crosby was buried in Quincy, Branch County{ XE "USA, Michigan, Branch County, Quincy:(41.9442° N, 84.8839° W):Sears, Clarke Crosby (1827-1915)" \f "Place" }.^[253]

More facts and events for Clarke Crosby Sears:

Residence: 1900 Quincy, Branch{ XE "USA, Michigan, Branch, Quincy:(41.9442° N, 84.8839° W):Sears, Clarke Crosby (1827-1915)" \f "Place" }^[269]

Marital Status: Married; Relation to Head: Head

At the age of 23, Clarke Crosby Sears married **Harriet Elizabeth Warner**{ XE "Warner:Harriet Elizabeth (1832-1913)" \f "Name" \b \i } on Thursday, 10th April 1851, in Orleans, New York,{ XE "USA, New York, Orleans:(43.3682° N, 78.2288° W):Sears,

²⁶⁸ Ancestry.com, North America, Family Histories, 1500-2000 (Provo, UT, USA, Ancestry.com Operations, Inc., 2016), Ancestry.com, Book Title: The descendants of Andrew Warner.

²⁶⁹ Ancestry.com, 1900 United States Federal Census (Provo, UT, USA, Ancestry.com Operations Inc, 2004), Ancestry.com, Year: 1900; Census Place: Quincy, Branch, Michigan; Roll: 704; Page: 4A; Enumeration District: 0018; FHL microfilm: 1240704.

Clarke Crosby (1827–1915)" \f "Place" } when she was 18 years old.^[253, 267–269] They had four children: Charles (1853–1923), Florence (1855–), Helen (1859–1934) and George (1863–).

Harriet Elizabeth was born in Phelps, Ontario,{ XE "USA, New York, Ontario, Phelps:(42.9576° N, 77.0575° W):Warner, Harriet Elizabeth (1832–1913)" \f "Place" } on Thursday, 13th September 1832.^[253, 268, 269] She was the daughter of John Warner{ XE "Warner:John (1806–)" \f "Name" \i } and Susan --Warner{ XE "--Warner:Susan (1810–)" \f "Name" \i }.

Harriet Elizabeth reached 80 years of age and died in Quincy{ XE "USA, Michigan, Branch, Quincy:(41.9442° N, 84.8839° W):Warner, Harriet Elizabeth (1832–1913)" \f "Place" } in 1913.^[253, 268] She was buried in Quincy, Branch County{ XE "USA, Michigan, Branch County, Quincy:(41.9442° N, 84.8839° W):Warner, Harriet Elizabeth (1832–1913)" \f "Place" }.^[253]

Joseph Sears{ TC "Joseph Sears" \I 3 \f C}

153. Joseph Crane⁴ Sears{ XE "Sears:Joseph Crane (1792–1857)" \f "Name" \b } (*Comfort³, James²*) was born on Tuesday, 18th December 1792, in Ridgefield, Fairfield, Connecticut, USA{ XE "USA, Connecticut, Fairfield, Ridgefield:(41.2815° N, 73.4982° W):Sears, Joseph Crane (1792–1857)" \f "Place" }.^[270, 271] He was the son of Comfort Sears{ XE "Sears:Comfort (1751–1827)" \f "Name" \i } (60) and Eunice Crane{ XE "Crane:Eunice (1754–1839)" \f "Name" \i } (61).

His estate was probated in 1857 in Hartford{ XE "USA, Connecticut, Hartford:(41.8071° N, 72.735° W):Sears, Joseph Crane (1792–1857)" \f "Place" }.^[271] Joseph Crane died in Millplain{ XE "USA, Connecticut, Millplain: :Sears, Joseph Crane (1792–1857)" \f "Place" } on 29th May 1857, at the age of 64.^[270, 271]

!S.P. May p.284 Joseph Sears lived in South East, NY, till 1827-7, when he removed to his father's place, remaining there til 1836, when he purchased the farm of his brother James in Millplain, Ct. The house that Herman B Sears was born in, was also the birthplace of George Belden Sears. The old boundary line between CT and NY passed through the house, and the room they were born in was on the New York side. By a later survey the whole house is in CT. Mr Sears was a public spirited man, and interested in all improvements. He was a Rep to State Leg in 1835-6, and 1842. He was greatly loved by all his neighbors, especially the young, was an active church member, often on committees, and in 1829 sent to the Presbytery.

<https://www.wikitree.com/wiki/Sears-3195>

Marriages with Patty M Barnum and Mary A Brush (Page 188) are known.

²⁷⁰ Ancestry.com, Connecticut, Hale Cemetery Inscriptions and Newspaper Notices, 1629-1934 (Provo, UT, USA, Ancestry.com Operations, Inc., 2012), Ancestry.com.
[Source citation includes one media item]

²⁷¹ Ancestry.com, Connecticut, Wills and Probate Records, 1609-1999 (Provo, UT, USA, Ancestry.com Operations, Inc., 2015), Ancestry.com, Probate Files Collection, Early to 1880; Author: Connecticut State Library (Hartford, Connecticut); Probate Place: Hartford, Connecticut.
[Source citation includes one media item]

Family of Joseph Sears and Patty Barnum{ TC "Joseph Sears and Patty Barnum" \I 4 \f C}

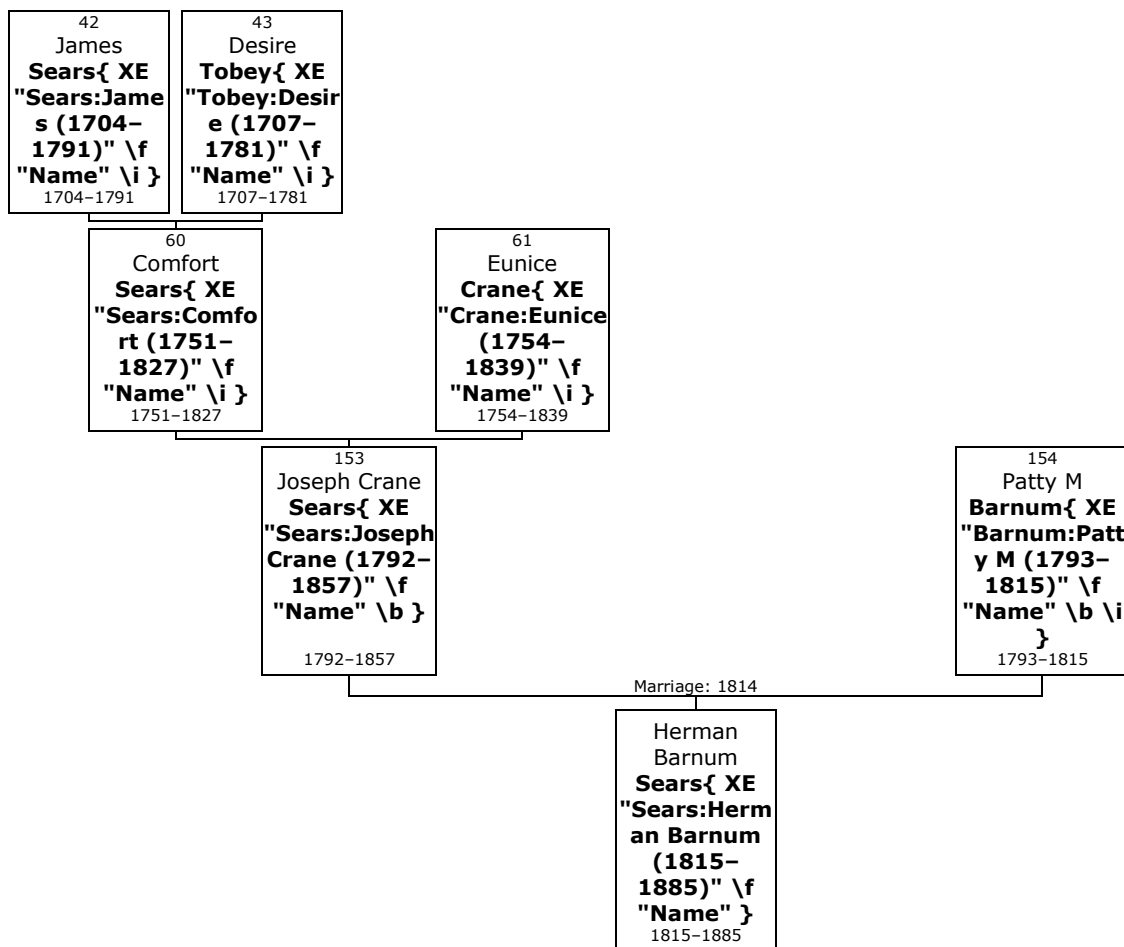

Here are the details about **Joseph Crane Sears{ XE "Sears:Joseph Crane (1792-1857)" \f "Name" \b }** first marriage, with Patty M Barnum. You can read more about Joseph Crane on page 185.

- 154.** At the age of 21, Joseph Crane Sears married **Patty M Barnum{ XE "Barnum:Patty M (1793-1815)" \f "Name" \b \i }** on Wednesday, 26th October 1814, when she was 20 years old.^[272, 273] They had one son: Herman (1815-1885).

Patty M was born in Southeast, Putnam, New York,{ XE "USA, New York, Putnam, Southeast:(41.4054° N, 73.6001° W):Barnum, Patty M (1793-1815)" \f "Place" } on Monday, 9th December 1793.^[272] She reached 21 years of age and died in Southeast{ XE "USA, New York, Putnam, Southeast:(41.4054° N, 73.6001° W):Barnum, Patty M (1793-1815)" \f "Place" } on 14th November 1815.^[273] Patty M was buried in Old Cemetery, Milltown, Dutchess{ XE "USA, New York, Dutchess, Milltown, Old Cemetery: :Barnum, Patty M (1793-1815)" \f "Place" }.^[273]

Son of Joseph Crane Sears and Patty M Barnum:

- m I. **Herman Barnum⁵ Sears{ XE "Sears:Herman Barnum (1815-1885)" \f "Name" \b }** was born in Southeast, Putnam,{ XE "USA, New York, Putnam, Southeast:(41.4054° N, 73.6001° W):Sears, Herman Barnum (1815-1885)" \f "Place" } on 11th November 1815.^[274, 275, 276, 277-278] He died in 1885 at the age of 69.

²⁷² Ancestry.com, New York, Genealogical Records, 1675-1920 (Provo, UT, USA, Ancestry.com Operations Inc, 2004), Ancestry.com, The New York Genealogical and Biographical Record (quarterly-1902) - Extracts; Publication Place: New York; Publisher: New York Genealogical and Biographical Society; Page Number: 138.

²⁷³ Ancestry.com, U.S., Find A Grave Index, 1600s-Current (Provo, UT, USA, Ancestry.com Operations, Inc., 2012), Ancestry.com.

²⁷⁴ Ancestry.com, California, Voter Registers, 1866-1898 (Provo, UT, USA, Ancestry.com Operations, Inc., 2011), Ancestry.com, California State Library, California History Section; Great Registers, 1866-1898; Collection Number: 4 - 2A; CSL Roll Number: 1; FHL Roll Number: 976446.

More facts and events for Herman Barnum Sears:

- Residence: 1855 Ward 16, Manhattan, New York, New York{ XE "USA, New York, New York, Manhattan, Ward 16: :Sears, Herman Barnum (1815-1885)" \f "Place" }^[276]
Relation to Head of House: Head
- Residence: 1876 Alameda, California{ XE "USA, California, Alameda:(37.6539° N, 121.914° W):Sears, Herman Barnum (1815-1885)" \f "Place" }^[274]
- Residence: 1892 Alameda{ XE "USA, California, Alameda:(37.6539° N, 121.914° W):Sears, Herman Barnum (1815-1885)" \f "Place" }^[275]

At the age of 24, Herman Barnum married **Harriet Almira Raymond**{ XE "Raymond:Harriet Almira (1819-)" \f "Name" \b \i } on Wednesday, 1st January 1840, in Patterson, Putnam, New York,{ XE "USA, New York, Putnam, Patterson:(41.5136° N, 73.6067° W):Sears, Herman Barnum (1815-1885)" \f "Place" } when she was 20 years old.^[276, 279-280] They had five children: Mary (1840-), Joseph (1847-1927), Charles (1850->1930), Carrie (1856-1924) and Herman (1860-).

Harriet Almira was born in Dutchess{ XE "USA, New York, Dutchess:(41.7645° N, 73.7472° W):Raymond, Harriet Almira (1819-)" \f "Place" } on Friday, 8th October 1819.^[276, 279, 280] She was the daughter of John Raymond{ XE "Raymond:John (1795-1875)" \f "Name" \i } and Betsy Pickett{ XE "Pickett:Betsy (1797-1858)" \f "Name" \i }.

²⁷⁵ Ancestry.com, California, Voter Registers, 1866-1898 (Provo, UT, USA, Ancestry.com Operations, Inc., 2011), Ancestry.com, California State Library, California History Section; Great Registers, 1866-1898; Collection Number: 4 - 2A; CSL Roll Number: 3; FHL Roll Number: 976448.

²⁷⁶ Ancestry.com, New York, State Census, 1855 (Provo, UT, USA, Ancestry.com Operations, Inc., 2013), Ancestry.com.

²⁷⁷ Ancestry.com, Illinois, Marriage Index, 1860-1920 (Provo, UT, USA, Ancestry.com Operations, Inc., 2015), Ancestry.com.

²⁷⁸ Dodd, Jordan, Illinois Marriages to 1850 (Provo, UT, USA, Ancestry.com Operations Inc, 1997), Ancestry.com.

²⁷⁹ Ancestry.com, 1850 United States Federal Census (Provo, UT, USA, Ancestry.com Operations, Inc., 2009), Ancestry.com, Year: 1850; Census Place: New York Ward 9 District 3, New York, New York; Roll: M432_544; Page: 403B; Image: 318. [Source citation includes one media item]

²⁸⁰ Ancestry.com, 1860 United States Federal Census (Provo, UT, USA, Ancestry.com Operations, Inc., 2009), Ancestry.com, Year: 1860; Census Place: New York Ward 16 District 1, New York, New York; Roll: M653_806; Page: 356; Family History Library Film: 803806. [Source citation includes one media item]

Family of Joseph Sears and Mary Brush{ TC "Joseph Sears and Mary Brush" \I 4 \f C}

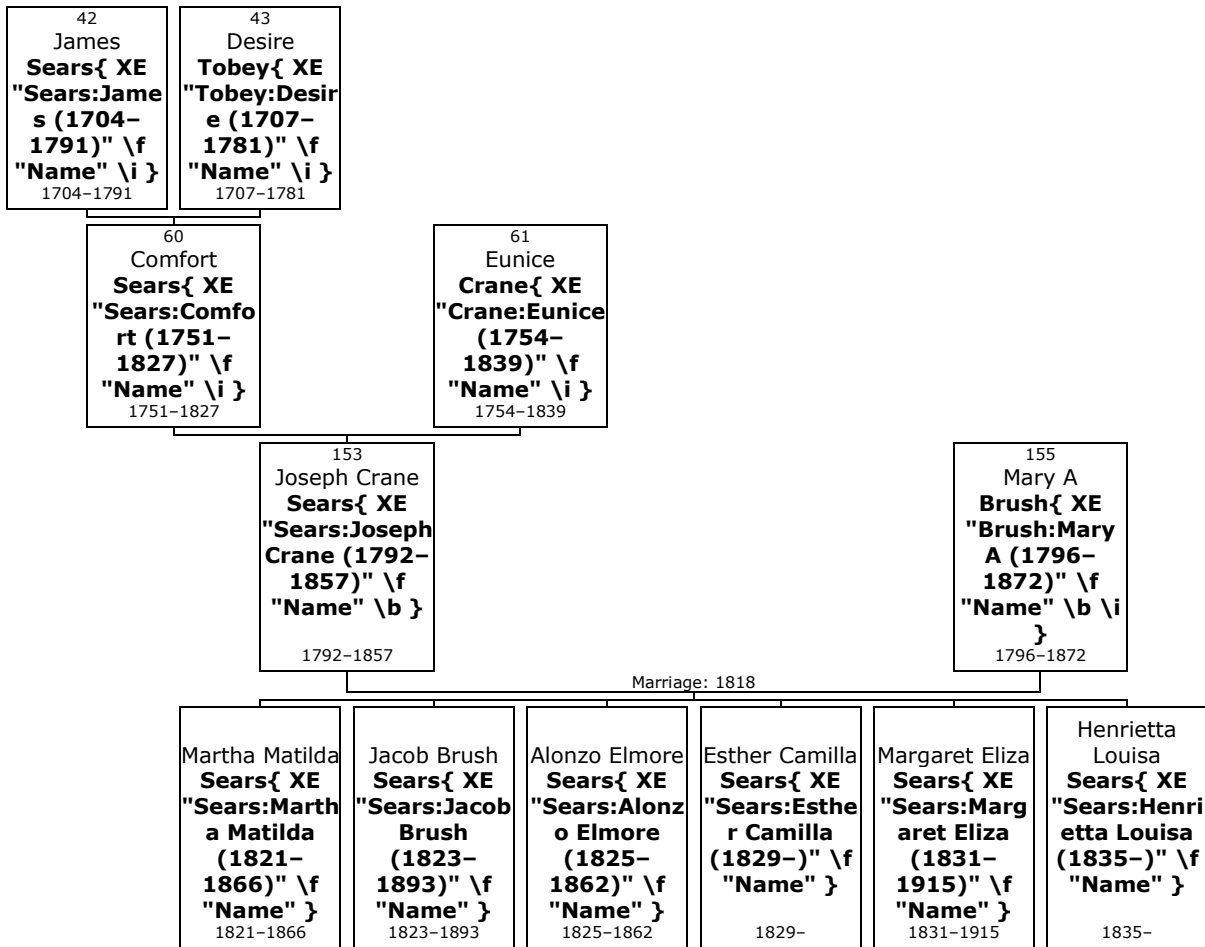

Here are the details about **Joseph Crane Sears**{ XE "Sears:Joseph Crane (1792-1857)" \f "Name" \b } second marriage, with **Mary A Brush**. You can read more about Joseph Crane on page 185.

- 155.** At the age of 25, Joseph Crane Sears married **Mary A Brush**{ XE "Brush:Mary A (1796-1872)" \f "Name" \b \i } on Sunday, 22nd February 1818, when she was 22 years old.^[270] They had six children: Martha (1821-1866), Jacob (1823-1893), Alonzo (1825-1862), Esther (1829-), Margaret (1831-1915) and Henrietta (1835-).

Mary A was born in perh, Southeast, Putnam, New York,{ XE "USA, New York, Putnam, Southeast, perh: :Brush, Mary A (1796-1872)" \f "Place" } on Sunday, 3rd January 1796.^[270] She reached 76 years of age and died in Camden, Camden, New Jersey,{ XE "USA, New Jersey, Camden, Camden:(39.926° N, 75.1196° W):Brush, Mary A (1796-1872)" \f "Place" } on 13th December 1872.^[270]

!S.P. May p.283 Died at the house of her daughter Camilla

Children of Joseph Crane Sears and Mary A Brush:

- f I. **Martha Matilda⁵ Sears**{ XE "Sears:Martha Matilda (1821-1866)" \f "Name" \b } was born in Southeast, Putnam, New York,{ XE "USA, New York, Putnam, Southeast:(41.4054° N, 73.6001° W):Sears, Martha Matilda (1821-1866)" \f "Place" } on 5th March 1821.^[273] She died in Danbury, Fairfield, Connecticut,{ XE "USA, Connecticut, Fairfield, Danbury:(41.3948° N, 73.454° W):Sears, Martha Matilda (1821-1866)" \f "Place" } in 1866 at the age of 44.^[273] Martha Matilda was buried in Danbury{ XE "USA, Connecticut, Fairfield, Danbury:(41.3948° N, 73.454° W):Sears, Martha Matilda (1821-1866)" \f "Place" }.^[273]



Martha

At the age of 32, Martha Matilda married **Lyman Platt**{ XE "Platt:Lyman (1819–1866)" \f "Name" \b \i } on Sunday, 7th August 1853, when he was 34 years old.^[273, 281] They had two children: Anne (1854–1860) and Joseph (1862–1956).

Lyman was born in Danbury{ XE "USA, Connecticut, Fairfield, Danbury:(41.3948° N, 73.454° W):Platt, Lyman (1819–1866)" \f "Place" } on Friday, 1st January 1819.^[273, 281] He reached 47 years of age and died in Danbury{ XE "USA, Connecticut, Fairfield, Danbury:(41.3948° N, 73.454° W):Platt, Lyman (1819–1866)" \f "Place" } on 23rd July 1866.^[273]

Lyman was buried in Danbury{ XE "USA, Connecticut, Fairfield, Danbury:(41.3948° N, 73.454° W):Platt, Lyman (1819–1866)" \f "Place" }.^[273]

- m II. **Jacob Brush Sears**{ XE "Sears:Jacob Brush (1823–1893)" \f "Name" \b } was born in Southeast{ XE "USA, New York, Putnam, Southeast:(41.4054° N, 73.6001° W):Sears, Jacob Brush (1823–1893)" \f "Place" } on 9th April 1823.^[273, 282, 283, 284–285] He died in 1893 at the age of 69.^[273] Jacob Brush was buried in Troy, Bradford County{ XE "USA, Pennsylvania, Bradford County, Troy:(41.7859° N, 76.788° W):Sears, Jacob Brush (1823–1893)" \f "Place" }.^[273]

More facts and events for Jacob Brush Sears:

Residence: 1880 Landis, Cumberland, New Jersey{ XE "USA, New Jersey, Cumberland, Landis:(39.3746° N, 74.9638° W):Sears, Jacob Brush (1823–1893)" \f "Place" }.^[282]

Marital status: Married; Relation to Head of House: Self

Residence: 1900 Troy, Bradford, Pennsylvania{ XE "USA, Pennsylvania, Bradford, Troy:(41.7859° N, 76.788° W):Sears, Jacob Brush (1823–1893)" \f "Place" }.^[283]

Marital Status: Married; Relation to Head: Father in Law

At the age of 22, Jacob Brush Sears married **Harriet Northrop**{ XE "Northrop:Harriet (1824–1911)" \f "Name" \b \i } on Wednesday, 4th February 1846, in Danbury, Fairfield, Connecticut,{ XE "USA, Connecticut, Fairfield, Danbury:(41.3948° N, 73.454° W):Sears, Jacob Brush (1823–1893)" \f "Place" } when she was 22 years old.^[273, 282–286] They had two daughters: Mary (1847–1934) and Emma (1852–1874).

Harriet was born in Southeast, Putnam, New York,{ XE "USA, New York, Putnam, Southeast:(41.4054° N, 73.6001° W):Northrop, Harriet (1824–1911)" \f "Place" } on Saturday, 24th January 1824.^[273, 282–284, 286] She reached 86 years of age and died in 1911.^[273] Harriet was buried in Troy, Bradford County{ XE "USA, Pennsylvania, Bradford County, Troy:(41.7859° N, 76.788° W):Northrop, Harriet (1824–1911)" \f "Place" }.^[273]

!maybe sister to Francis #8132

- ²⁸¹ Ancestry.com and The Church of Jesus Christ of Latter-day Saints, 1880 United States Federal Census (Provo, UT, USA, Ancestry.com Operations Inc, 2010), Ancestry.com, Year: 1880; Census Place: Danbury, Fairfield, Connecticut; Roll: 94; Family History Film: 1254094; Page: 33D; Enumeration District: 111; Image: 0067. [Source citation includes one media item]
- ²⁸² Ancestry.com and The Church of Jesus Christ of Latter-day Saints, 1880 United States Federal Census (Provo, UT, USA, Ancestry.com Operations Inc, 2010), Ancestry.com, Year: 1880; Census Place: Landis, Cumberland, New Jersey; Roll: 776; Family History Film: 1254776; Page: 331D; Enumeration District: 083; Image: 0032.
- ²⁸³ Ancestry.com, 1900 United States Federal Census (Provo, UT, USA, Ancestry.com Operations Inc, 2004), Ancestry.com, Year: 1900; Census Place: Troy, Bradford, Pennsylvania; Roll: 1383; Page: 1B; Enumeration District: 0047; FHL microfilm: 1241383.
- ²⁸⁴ Ancestry.com, Pennsylvania, Death Certificates, 1906-1963 (Provo, UT, USA, Ancestry.com Operations, Inc., 2014), Ancestry.com, Pennsylvania Historic and Museum Commission; Pennsylvania, USA; Certificate Number Range: 003501-006500.
- ²⁸⁵ Ancestry.com, New Jersey, Marriage Records, 1670-1965 (Lehi, UT, USA, Ancestry.com Operations, Inc., 2016), Ancestry.com.
- ²⁸⁶ Ancestry.com, 1910 United States Federal Census (Provo, UT, USA, Ancestry.com Operations Inc, 2006), Ancestry.com, Year: 1910; Census Place: Troy, Bradford, Pennsylvania; Roll: T624_1319; Page: 11B; Enumeration District: 0044; FHL microfilm: 1375332. [Source citation includes one media item]

- m III. **Alonzo Elmore Sears**{ XE "Sears:Alonzo Elmore (1825–1862)" \f "Name" \b } was born in Southeast{ XE "USA, New York, Putnam, Southeast:(41.4054° N, 73.6001° W):Sears, Alonzo Elmore (1825–1862)" \f "Place" } on 3rd October 1825.^[287, 288–289] He died in Manhattan, New York,{ XE "USA, New York, New York, Manhattan:(40.7834° N, 73.9663° W):Sears, Alonzo Elmore (1825–1862)" \f "Place" } on 30th July 1862, at the age of 36.^[287, 288]

More facts and events for Alonzo Elmore Sears:

Residence: 1st July 1863

Cameron, Steuben{ XE "USA, New York, Steuben, Cameron:(42.1992° N, 77.4067° W):Sears, Alonzo Elmore (1825–1862)" \f "Place" }^[289]

At the age of 27, Alonzo Elmore Sears married **Susan A Smith**{ XE "Smith:Susan A (1829–)" \f "Name" \b \i } on Thursday, 23rd June 1853, in North Salem, Westchester,{ XE "USA, New York, Westchester, North Salem:(41.3347° N, 73.5717° W):Sears, Alonzo Elmore (1825–1862)" \f "Place" } when she was 24 years old. They had three children: Marion (1857–1930), Gertrude (1859–) and Edward (1860–1861).

Susan A was born in North Salem{ XE "USA, New York, Westchester, North Salem:(41.3347° N, 73.5717° W):Smith, Susan A (1829–)" \f "Place" } on Tuesday, 10th March 1829.

- f IV. **Esther Camilla Sears**{ XE "Sears:Esther Camilla (1829–)" \f "Name" \b } was born in Ridgefield, Fairfield, Connecticut,{ XE "USA, Connecticut, Fairfield, Ridgefield:(41.2815° N, 73.4982° W):Sears, Esther Camilla (1829–)" \f "Place" } on 21st August 1829.^[290]

At the age of 24, Esther Camilla Sears married **James A Perry**{ XE "Perry:James A (1821–)" \f "Name" \b \i } on Wednesday, 28th June 1854, in Danbury{ XE "USA, Connecticut, Fairfield, Danbury:(41.3948° N, 73.454° W):Sears, Esther Camilla (1829–)" \f "Place" } when he was 33 years old.^[290] They had four children: Norman (1855–), Emma (1857–1940), Anna (1863–) and Mary (1867–).

James A was born in Patterson, Putnam, New York,{ XE "USA, New York, Putnam, Patterson:(41.5136° N, 73.6067° W):Perry, James A (1821–)" \f "Place" } on Thursday, 15th March 1821.

!S.P. May p.283 Was a lumber merchant in Buffalo, NY, and rem. to 2642 Brown st., Phila, PA

- f V. **Margaret Eliza Sears**{ XE "Sears:Margaret Eliza (1831–1915)" \f "Name" \b } was born in Ridgefield{ XE "USA, Connecticut, Fairfield, Ridgefield:(41.2815° N, 73.4982° W):Sears, Margaret Eliza (1831–1915)" \f "Place" } on 27th August 1831. She died in 1915 at the age of 83.

- f VI. **Henrietta Louisa Sears**{ XE "Sears:Henrietta Louisa (1835–)" \f "Name" \b } was born in Ridgefield{ XE "USA, Connecticut, Fairfield, Ridgefield:(41.2815° N, 73.4982° W):Sears, Henrietta Louisa (1835–)" \f "Place" } on 31st March 1835.^[291]

²⁸⁷ Ancestry.com, U.S., Newspaper Extractions from the Northeast, 1704-1930 (Provo, UT, USA, Ancestry.com Operations, Inc., 2014), Ancestry.com.

²⁸⁸ Ancestry.com, Connecticut, Deaths and Burials Index, 1650-1934 (Provo, UT, USA, Ancestry.com Operations, Inc., 2011), Ancestry.com.

²⁸⁹ Ancestry.com, U.S., Civil War Draft Registrations Records, 1863-1865 (Provo, UT, USA, Ancestry.com Operations, Inc., 2010), Ancestry.com, National Archives and Records Administration (NARA); Washington, D.C.; Consolidated Lists of Civil War Draft Registration Records (Provost Marshal General's Bureau; Consolidated Enrollment Lists, 1863-1865); Record Group: 110, Records of the Provost Marsh.

²⁹⁰ Ancestry.com, West Virginia, Deaths Index, 1853-1973 (Provo, UT, USA, Ancestry.com Operations, Inc., 2011), Ancestry.com, Record for Emma Camilla Smith.
<http://search.ancestry.com/cgi-bin/sse.dll?db=2568&h=1896995&indiv=try>.

²⁹¹ Ancestry.com and The Church of Jesus Christ of Latter-day Saints, 1880 United States Federal Census (Provo, UT, USA, Ancestry.com Operations Inc, 2010), Ancestry.com, Year: 1880; Census Place: Danbury, Fairfield, Connecticut; Roll: 94; Family History Film: 1254094; Page: 103C; Enumeration District: 113; Image: 0206.

More facts and events for Henrietta Louisa Sears:

Residence: 1880 Danbury{ XE "USA, Connecticut, Fairfield, Danbury:(41.3948° N, 73.454° W):Sears, Henrietta Louisa (1835-)" \f "Place" }^[291]
 Marital status: Married; Relation to Head of House: Wife

Henrietta Louisa Sears married **Charles H Crosby**{ XE "Crosby:Charles H (1831-)" \f "Name" \b \i } in Danbury{ XE "USA, Connecticut, Fairfield, Danbury:(41.3948° N, 73.454° W):Sears, Henrietta Louisa (1835-)" \f "Place" }^[291] They had three children: Jennie (ca.1852-), Charles (1861-1865) and Frances (1873-).

Charles H was born in Cold Spring, Cattaraugus, New York,{ XE "USA, New York, Cattaraugus, Cold Spring:(42.0969° N, 78.865° W):Crosby, Charles H (1831-)" \f "Place" } on Wednesday, 25th May 1831.^[291]

!S.P. May p.284 Lives in Bridgeport, CT

Family of Lewis Sears and Sarah Crosby{ TC "Lewis Sears and Sarah Crosby" \I 3 \f C}

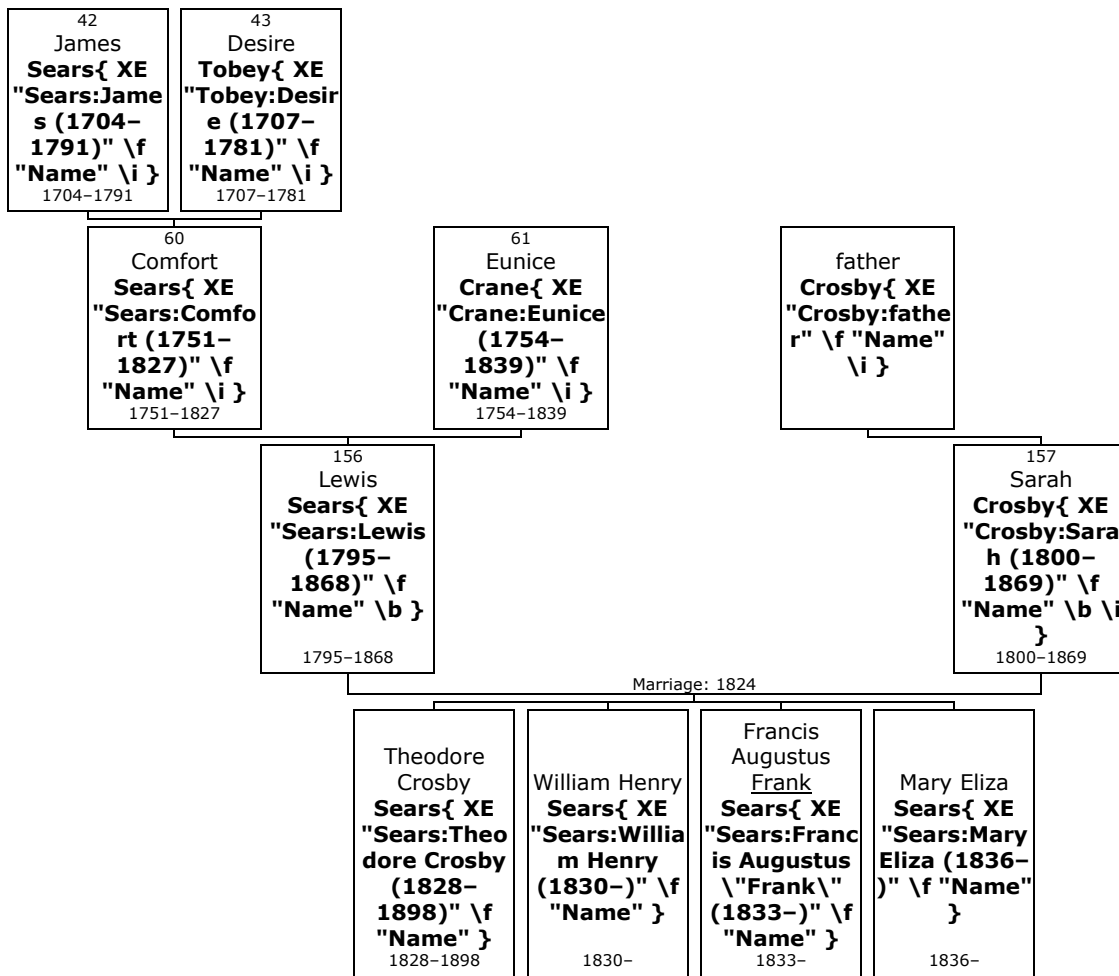

156. Dea Lewis⁴ Sears{ XE "Sears:Lewis (1795-1868)" \f "Name" \b } (*Comfort³, James²*) was born on Friday, 26th June 1795, in Ridgefield, Fairfield, Connecticut, USA{ XE "USA, Connecticut, Fairfield, Ridgefield:(41.2815° N, 73.4982° W):Sears, Lewis (1795-1868)" \f "Place" }^[292, 293] He was the son of

²⁹² Ancestry.com, Connecticut, Deaths and Burials Index, 1650-1934 (Provo, UT, USA, Ancestry.com Operations, Inc., 2011), Ancestry.com.

²⁹³ Ancestry.com, Connecticut, Hale Cemetery Inscriptions and Newspaper Notices, 1629-1934 (Provo, UT, USA, Ancestry.com Operations, Inc., 2012), Ancestry.com.
 [Source citation includes one media item]

Comfort Sears{ XE "Sears:Comfort (1751-1827)" \f "Name" \i } (60) and Eunice Crane{ XE "Crane:Eunice (1754-1839)" \f "Name" \i } (61).

Lewis died in Danbury{ XE "USA, Connecticut, Fairfield, Danbury:(41.3948° N, 73.454° W):Sears, Lewis (1795-1868)" \f "Place" } on 10th November 1868, at the age of 73.^[292, 293]

S P May p 284 No 790

<https://www.wikitree.com/wiki/Sears-4792>

- 157.** At the age of 29, Lewis married **Sarah Crosby**{ XE "Crosby:Sarah (1800-1869)" \f "Name" \b \i } on Thursday, 30th September 1824, in Phelps, Ontario, New York,{ XE "USA, New York, Ontario, Phelps:(42.9576° N, 77.0575° W):Sears, Lewis (1795-1868)" \f "Place" } when she was 24 years old. They had four children: Theodore (1828-1898), William (1830-), Frank (1833-) and Mary (1836-).

Sarah was born in Southeast, Putnam,{ XE "USA, New York, Putnam, Southeast:(41.4054° N, 73.6001° W):Crosby, Sarah (1800-1869)" \f "Place" } on Friday, 27th June 1800. She was the daughter of father Crosby{ XE "Crosby:father" \f "Name" \i }.

Sarah reached 68 years of age and died in Buffalo, Erie,{ XE "USA, New York, Erie, Buffalo:(42.8865° N, 78.8784° W):Crosby, Sarah (1800-1869)" \f "Place" } on 31st May 1869.

Children of Lewis Sears and Sarah Crosby:

m

- I. **Theodore Crosby⁵ Sears**{ XE "Sears:Theodore Crosby (1828-1898)" \f "Name" \b } was born in Danbury, Fairfield, Connecticut,{ XE "USA, Connecticut, Fairfield, Danbury:(41.3948° N, 73.454° W):Sears, Theodore Crosby (1828-1898)" \f "Place" } on 4th August 1828.^[294, 295, 296-297] He was known by the title of Hon.



Theodore

Theodore Crosby died in Lakeview, Grant,{ XE "USA, Washington, Grant, Lakeview:(47.374° N, 119.5023° W):Sears, Theodore Crosby (1828-1898)" \f "Place" } on 8th November 1898, at the age of 70.^[294] He was buried.^[294] Tacoma Cem.

More facts and events for Theodore Crosby Sears:

Residence: 1880

Ottawa, Franklin, Kansas{ XE "USA, Kansas, Franklin, Ottawa:(38.6156° N, 95.2678° W):Sears, Theodore Crosby (1828-1898)" \f "Place" }^[296]

Marital status: Married; Relation to Head of House: Self

Residence: 4th April 1887

Tacoma, Pierce, Washington{ XE "USA, Washington, Pierce, Tacoma:(47.2529° N, 122.4443° W):Sears, Theodore Crosby (1828-1898)" \f "Place" }^[295]

Marital Status: Single

²⁹⁴ Ancestry.com, U.S., Find A Grave Index, 1600s-Current (Provo, UT, USA, Ancestry.com Operations, Inc., 2012), Ancestry.com.

²⁹⁵ Ancestry.com, Washington State and Territorial Censuses, 1857-1892 (Provo, UT, USA, Ancestry.com Operations Inc, 2006), Ancestry.com.

²⁹⁶ Ancestry.com and The Church of Jesus Christ of Latter-day Saints, 1880 United States Federal Census (Provo, UT, USA, Ancestry.com Operations Inc, 2010), Ancestry.com, Year: 1880; Census Place: Ottawa, Franklin, Kansas; Roll: 381; Family History Film: 1254381; Page: 129D; Enumeration District: 088; Image: 0709.

²⁹⁷ Ancestry.com, Ohio, County Marriages, 1774-1993 (Lehi, UT, USA, Ancestry.com Operations, Inc., 2016), Ancestry.com.

At the age of 23, Theodore Crosby married **Elizabeth H Hoyt**{ XE "Hoyt:Elizabeth H (1829-1886)" \f "Name" \b \i } on Monday, 27th October 1851, in New York{ XE "USA, New York:(42.7531° N, 74.2224° W):Sears, Theodore Crosby (1828-1898)" \f "Place" } when she was 22 years old.^[294, 296, 297] They had five children: Theodore (1853-1920), Louis (1855-1925), Gussie (1861-1951), Elizabeth (1864-1866) and Allison (1869-).

Elizabeth H was born in Bethel, Fairfield, Connecticut,{ XE "USA, Connecticut, Fairfield, Bethel:(41.3729° N, 73.4114° W):Hoyt, Elizabeth H (1829-1886)" \f "Place" } on Saturday, 8th August 1829.^[294, 296]

She was the daughter of Starr Hoyt{ XE "Hoyt:Starr (1803-)" \f "Name" \i } and Sally Maria Nichols{ XE "Nichols:Sally Maria (1807-)" \f "Name" \i }. Elizabeth H reached 56 years of age and died in Elmira, Chemung, New York,{ XE "USA, New York, Chemung, Elmira:(42.0898° N, 76.8078° W):Hoyt, Elizabeth H (1829-1886)" \f "Place" } on 5th January 1886.^[294] She was buried in Woodlawn Cemetery, Elmira,{ XE "USA, New York, Chemung, Elmira, Woodlawn Cemetery: :Hoyt, Elizabeth H (1829-1886)" \f "Place" } on 7th January 1886.^[294]

!BIRTH-DEATH: Letter from Helen M Sears, Rancho Mirage, CA, to Ray Sears; 1988;Letter dtd 22 Aug 1989; ; copy in poss of Ray Sears; died of cancer.

- m II. **William Henry Sears**{ XE "Sears:William Henry (1830-)" \f "Name" \b } was born in Danbury{ XE "USA, Connecticut, Fairfield, Danbury:(41.3948° N, 73.454° W):Sears, William Henry (1830-)" \f "Place" } on 23rd December 1830.^[298]

More facts and events for William Henry Sears:

Residence: 1866 San Francisco{ XE "USA, California, San Francisco:(37.7933° N, 122.5548° W):Sears, William Henry (1830-)" \f "Place" }^[298]
StreetAddress: 517 Leavenworth; Age: 36

William Henry Sears married **Rose Richmond**{ XE "Richmond:Rose (1834-)" \f "Name" \b \i }. They had no known children.

Rose was born in perh, Danbury, Fairfield, Connecticut,{ XE "USA, Connecticut, Fairfield, Danbury, perh: :Richmond, Rose (1834-)" \f "Place" } in 1834.

- m III. **Francis Augustus Frank Sears**{ XE "Sears:Francis Augustus \"Frank\" (1833-)" \f "Name" \b } was born in Danbury{ XE "USA, Connecticut, Fairfield, Danbury:(41.3948° N, 73.454° W):Sears, Francis Augustus \"Frank\" (1833-)" \f "Place" } on 18th September 1833.^[299, 300-301]

More facts and events for Francis Augustus Frank Sears:

Residence: 1850 Danbury, Fairfield, Connecticut{ XE "USA, Connecticut, Fairfield, Danbury:(41.3948° N, 73.454° W):Sears, Francis Augustus \"Frank\" (1833-)" \f "Place" }^[301]

Residence: 1st July 1863 Buffalo, Erie, New York{ XE "USA, New York, Erie, Buffalo:(42.8865° N, 78.8784° W):Sears, Francis Augustus \"Frank\" (1833-)" \f "Place" }^[299]

²⁹⁸ Ancestry.com, California, Voter Registers, 1866-1898 (Provo, UT, USA, Ancestry.com Operations, Inc., 2011), Ancestry.com, California State Library; Sacramento, California; Great Registers, 1866-1898; Collection Number: 4-2A; CSL Roll Number: 43; FHL Roll Number: 977099. Record for William Henry Sears.
<http://search.ancestry.com/cgi-bin/sse.dll?db=2495&h=80642725&indiv=try>.

²⁹⁹ Ancestry.com, U.S., Civil War Draft Registrations Records, 1863-1865 (Provo, UT, USA, Ancestry.com Operations, Inc., 2010), Ancestry.com, National Archives and Records Administration (NARA); Washington, D.C.; Consolidated Lists of Civil War Draft Registration Records (Provost Marshal General's Bureau; Consolidated Enrollment Lists, 1863-1865); Record Group: 110, Records of the Provost Marsh.

³⁰⁰ Ancestry.com, New York, State Census, 1865 (Provo, UT, USA, Ancestry.com Operations, Inc., 2014), Ancestry.com.

³⁰¹ Ancestry.com, 1850 United States Federal Census (Provo, UT, USA, Ancestry.com Operations, Inc., 2009), Ancestry.com, Year: 1850; Census Place: Danbury, Fairfield, Connecticut; Roll: M432_37; Page: 140B; Image: 284.

Residence: 1865

Marital Status: Married

Buffalo{ XE "USA, New York, Erie,
Buffalo:(42.8865° N, 78.8784° W):Sears,
Francis Augustus \"Frank\" (1833-)\" \f
\"Place\" }^[300]

Relation to Head of House: Head

At the age of 23, Francis Augustus Frank Sears married **Roxcellana Parish**{ XE
\"Parish:Roxcellana (1838-1867)\" \f \"Name\" \b \i } on Tuesday, 15th September 1857,
when she was 19 years old.^[300] They had four children: Stephen (1860-1898), Alfred
(1863-), Lewis (1865-) and Sarah (1867-1875).

Roxcellana was born in Canandaigua, Ontario,{ XE "USA, New York, Ontario,
Canandaigua:(42.8742° N, 77.2881° W):Parish, Roxcellana (1838-1867)\" \f \"Place\" }
on Thursday, 5th April 1838.^[300] She was the daughter of Isaac Parish{ XE \"Parish:Isaac
(1812-)\" \f \"Name\" \i }.

Roxcellana reached 29 years of age and died in Buffalo{ XE "USA, New York, Erie,
Buffalo:(42.8865° N, 78.8784° W):Parish, Roxcellana (1838-1867)\" \f \"Place\" } on 6th
September 1867.

- f
- IV. **Mary Eliza Sears**{ XE \"Sears:Mary Eliza (1836-)\" \f \"Name\" \b } was born in Danbury{
XE \"USA, Connecticut, Fairfield, Danbury:(41.3948° N, 73.454° W):Sears, Mary Eliza
(1836-)\" \f \"Place\" } on 15th October 1836.^[301]

More facts and events for Mary Eliza Sears:

Residence: 1850 Danbury{ XE \"USA, Connecticut, Fairfield,
Danbury:(41.3948° N, 73.454° W):Sears, Mary Eliza
(1836-)\" \f \"Place\" }^[301]

Family of Polly Sears and Nehemiah Perry{ TC "Polly Sears and Nehemiah Perry" \I 3 \f C}

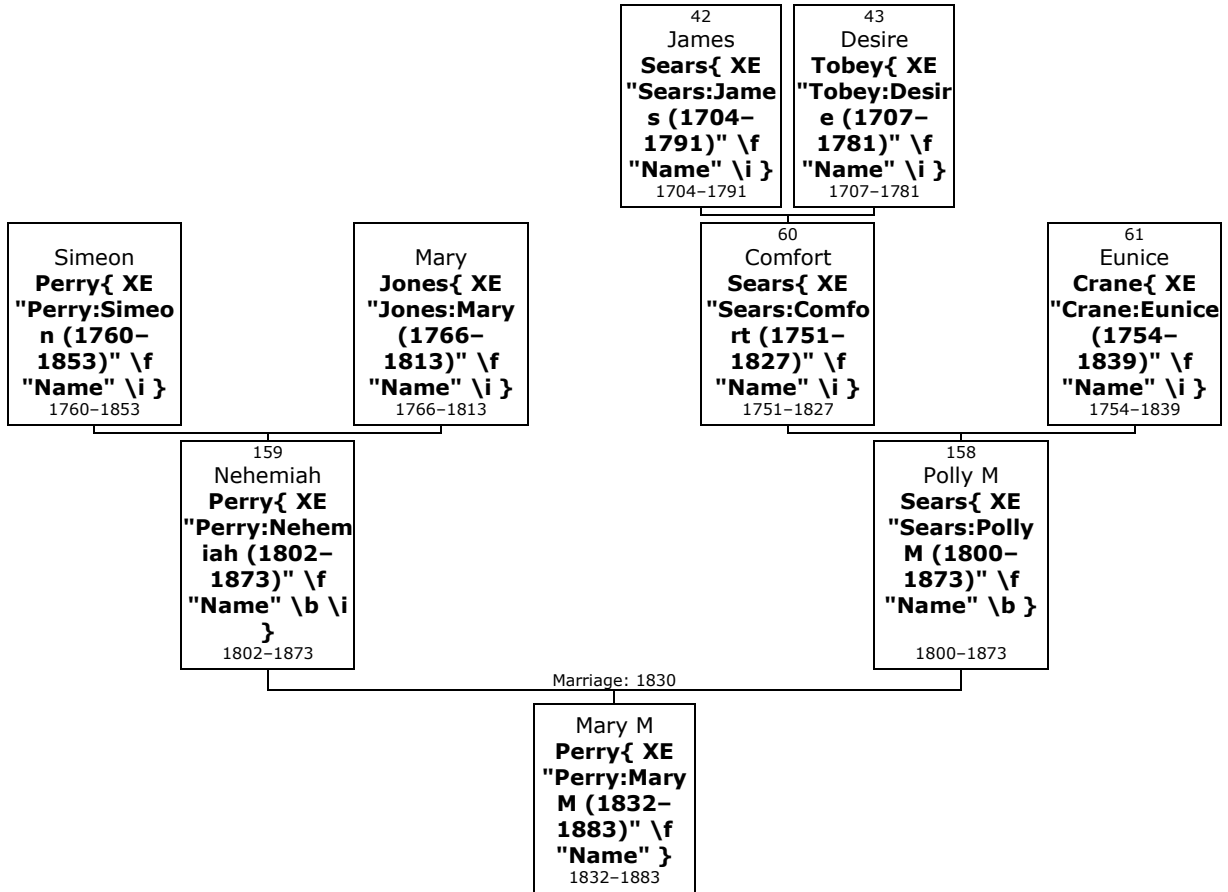

158. Polly M⁴ Sears{ XE "Sears:Polly M (1800-1873)" \f "Name" \b } (*Comfort³, James²*) was born on Saturday, 26th July 1800, in Ridgefield, Fairfield, Connecticut, USA{ XE "USA, Connecticut, Fairfield, Ridgefield:(41.2815° N, 73.4982° W):Sears, Polly M (1800-1873)" \f "Place" }.^[302] She was the daughter of Comfort Sears{ XE "Sears:Comfort (1751-1827)" \f "Name" \i } (60) and Eunice Crane{ XE "Crane:Eunice (1754-1839)" \f "Name" \i } (61).

Polly M died in Patterson{ XE "USA, New York, Putnam, Patterson:(41.5136° N, 73.6067° W):Sears, Polly M (1800-1873)" \f "Place" } on 12th April 1873, at the age of 72.^[302] She was buried in 72-8-16 Sears Burying Ground, Southeast{ XE "USA, New York, Putnam, Southeast, 72-8-16 Sears Burying Ground: :Sears, Polly M (1800-1873)" \f "Place" }.^[302]

<https://www.wikitree.com/wiki/Sears-4793>

More facts and events for Polly M Sears:

Residence: 1870 Patterson{ XE "USA, New York, Putnam, Patterson:(41.5136° N, 73.6067° W):Sears, Polly M (1800-1873)" \f "Place" }.^[302]

159. At the age of 30, Polly M married **Nehemiah Perry**{ XE "Perry:Nehemiah (1802-1873)" \f "Name" \b \i } on Wednesday, 22nd December 1830, in Southeast, Dutchess,{ XE "USA, New York, Dutchess, Southeast: :Sears, Polly M (1800-1873)" \f "Place" } when he was 28 years old.^[302] They had one daughter: Mary (1832-1883).

Nehemiah was born at was Franklin, Dutchess, New York in Patterson, Putnam,{ XE "USA, New York, Putnam, Patterson:(41.5136° N, 73.6067° W):Perry, Nehemiah (1802-1873)" \f "Place" } on Friday, 5th November 1802.^[302] He was the son of Simeon Perry{ XE "Perry:Simeon (1760-1853)" \f "Name" \i } and Mary Jones{ XE "Jones:Mary (1766-1813)" \f "Name" \i }.

Nehemiah reached 70 years of age and died in Patterson{ XE "USA, New York, Putnam, Patterson:(41.5136° N, 73.6067° W):Perry, Nehemiah (1802-1873)" \f "Place" } on 17th January

³⁰² "Ancestry Family Tree", Record for Nehemiah Perry. <https://familysearch.org/ark:/61903/4:1:LC88-91Q>.

1873.^[302] He was buried in Brewster Hill{ XE "USA, New York, Putnam, Brewster Hill:(41.424° N, 73.6043° W):Perry, Nehemiah (1802–1873)" \f "Place" }.^[302]

<https://www.ancestry.com/family-tree/person/tree/153818667/person/252032439359/facts>
Caiside7- Harwich, Barnstable, Massachusetts, USA- 9 Apr

Hi. I came across your tree on Ancestry. I'm researching Simeon Perry family Rev. soldier of Patterson, Putnam Co NY. I see that you have an error in your tree in regard to Nehemiah Perry, spouse of Polly M Sears. You don't have sources, so I can't check where you got this, but I offer this correction.

Nehemiah was born 5 Nov 1802 in Franklin, Dutchess Co NY. (now Patterson, Putnam Co.) son of Simeon Perry and Mary Jones Perry. Nehemiah and Polly Sears (dau of Comfort and Eunice Crane Sears) were married 22 Dec 1830 in Town of Southeast, NY, which differs from your marriage, (which I also have as a 2nd possibility) of 1831 in CT. Nehemiah died 17 Jan 1873 and Polly 12 Apr 1873. Both are buried in the Old Sears Burying Ground (aka, Old Southeast Church Cemetery) .

I've been trying for a long time to find Simeon Perry's parents with no luck. New York does not have good records. I suspect he may be related to the Perrys of Sandwich, MA, but can't make the link. I used to live in Putnam County NY, and live in Harwich, MA, now. It is fun to see so many of the Putnam County settler names (Sears, Crosby, Doane, etc.) on tombstones on the Cape.

Cheers,
Janet Cassidy
11:42 AM

PS: I just noticed a James A Perry b 1821 married to Esther Sears . You have him born in Paterson NJ. Are you sure that's correct? It would make more sense that he was born in Patterson, Putnam, NY, since it borders Danbury, Fairfield Co CT.

Patterson NY has a long history of name changes. I can explain if you are interested.
Janet

More facts and events for Nehemiah Perry:

Residence: 1850 Patterson{ XE "USA, New York, Putnam, Patterson:(41.5136° N, 73.6067° W):Perry, Nehemiah (1802–1873)" \f "Place" }.^[302]

Residence: 1860 Patterson{ XE "USA, New York, Putnam, Patterson:(41.5136° N, 73.6067° W):Perry, Nehemiah (1802–1873)" \f "Place" }.^[302]

Residence: 1870 Patterson{ XE "USA, New York, Putnam, Patterson:(41.5136° N, 73.6067° W):Perry, Nehemiah (1802–1873)" \f "Place" }.^[302]

Daughter of Polly M Sears and Nehemiah Perry:

f I. **Mary M⁵ Perry**{ XE "Perry:Mary M (1832–1883)" \f "Name" \b } was born in New York{ XE "USA, New York:(42.7531° N, 74.2224° W):Perry, Mary M (1832–1883)" \f "Place" } in 1832.^[302] She died in Patterson{ XE "USA, New York, Putnam, Patterson:(41.5136° N, 73.6067° W):Perry, Mary M (1832–1883)" \f "Place" } on 3rd February 1883, at the age of 51.^[302]

More facts and events for Mary M Perry:

Residence: 1880 Patterson{ XE "USA, New York, Putnam, Patterson:(41.5136° N, 73.6067° W):Perry, Mary M (1832–1883)" \f "Place" }.^[302]

Mary M married **Hawley Hayt**{ XE "Hayt:Hawley" \f "Name" \b \i }. They had two children: Edgar and Carrie.

Nephews/nieces{ TC "Nephews/nieces" \I 2 \f C}

Family of Arza Sears and Elizabeth Betts{ TC "Arza Sears and Elizabeth Betts" \I 3 \f C}

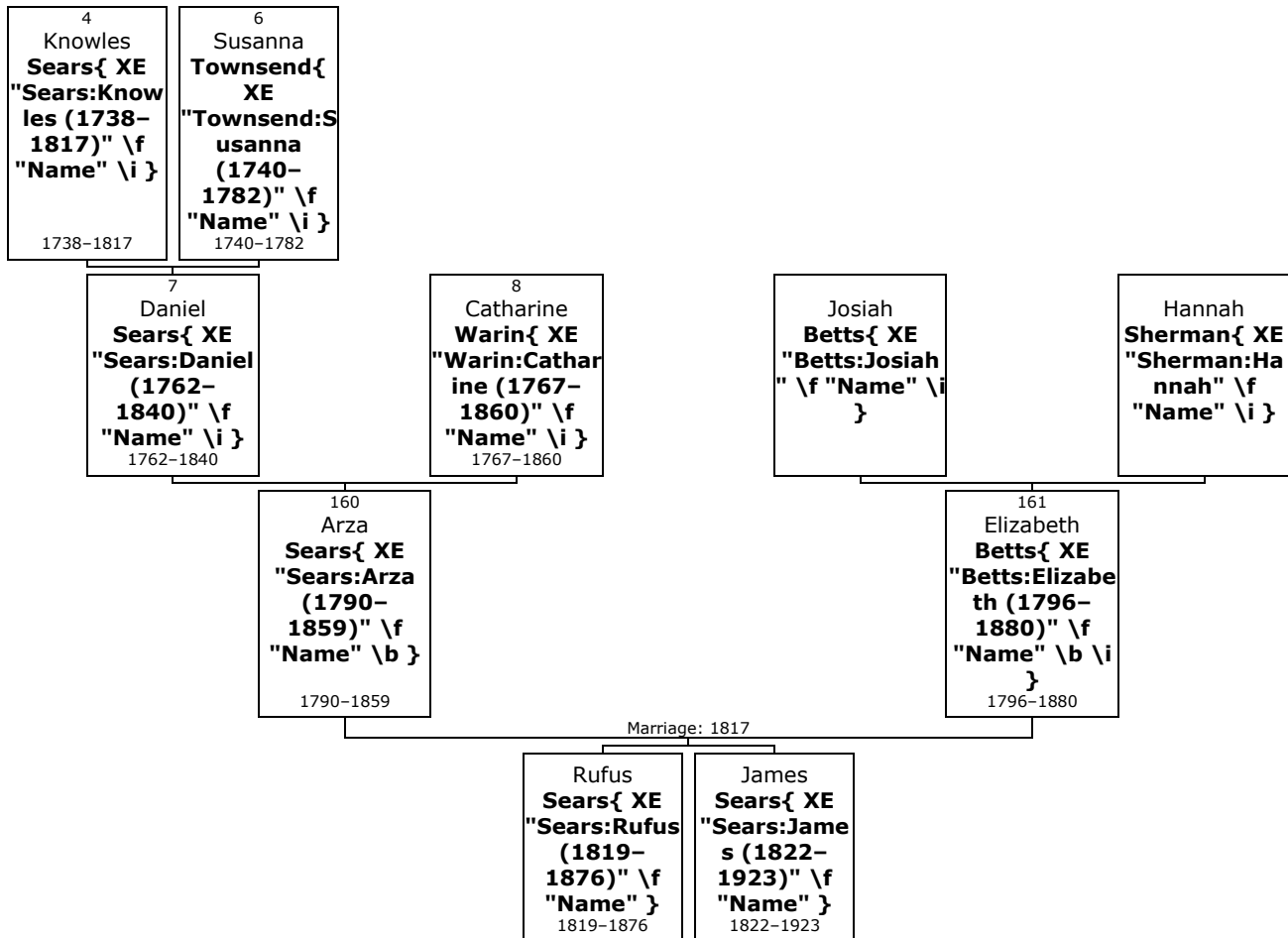

160. Arza⁵ Sears{ XE "Sears:Arza (1790-1859)" \f "Name" \b } (*Daniel⁴, Susanna³ Townsend*) was born on Sunday, 17th October 1790, in Rensselaerville, Albany, New York, USA{ XE "USA, New York, Albany, Rensselaerville:(42.5161° N, 74.1383° W):Sears, Arza (1790-1859)" \f "Place" }.^[303, 304] He was the son of Daniel Sears{ XE "Sears:Daniel (1762-1840)" \f "Name" \i } (7) and Catharine Warin{ XE "Warin:Catharine (1767-1860)" \f "Name" \i } (8).

Arza died in Baldwinsville{ XE "USA, New York, Onondaga, Baldwinsville:(43.1587° N, 76.3327° W):Sears, Arza (1790-1859)" \f "Place" } on 15th July 1859, at the age of 68.^[303] He was buried in Baldwinsville{ XE "USA, New York, Onondaga, Baldwinsville:(43.1587° N, 76.3327° W):Sears, Arza (1790-1859)" \f "Place" }.^[303]

!S P May No 1641

!

!Find A Grave Memorial# 51997466

Birth: Oct. 17, 1790 Rensselaerville Albany County New York, USA Death: Jul. 15, 1859 Baldwinsville Onondaga County New York, USA Family links: Parents: Daniel Sears (1762 - 1840) Catherine Warin Sears (1767 - 1860) Spouse: Elizabeth Betts Sears (1797 - 1880)* Children: Rufus Sears (1819 - 1876)* James Sears (1822 - 1923)* *Calculated relationship Burial: Sears Cemetery Baldwinsville Onondaga County New York, USA Created by: BAArnold Record added: May 04, 2010

³⁰³ Ancestry.com, U.S., Find A Grave Index, 1600s-Current (Provo, UT, USA, Ancestry.com Operations, Inc., 2012), Ancestry.com.

³⁰⁴ Ancestry.com, New York, State Census, 1855 (Provo, UT, USA, Ancestry.com Operations, Inc., 2013), Ancestry.com. [Source citation includes one media item]

<https://www.wikitree.com/wiki/Sears-3223>

More facts and events for Arza Sears:

Residence: 1855 Van Buren{ XE "USA, New York, Onondaga, Van Buren:(43.1136° N, 76.3025° W):Sears, Arza (1790–1859)" \f "Place" }^[304]
Relation to Head of House: Father

- 161.** At the age of 26, Arza married **Elizabeth Betts**{ XE "Betts:Elizabeth (1796–1880)" \f "Name" \b \i } on Sunday, 3rd August 1817, when she was 21 years old.^[303–305] They had two sons: Rufus (1819–1876) and James (1822–1923).

Elizabeth was born in perh, Van Buren, { XE "USA, New York, Onondaga, Van Buren, perh: :Betts, Elizabeth (1796–1880)" \f "Place" } on Friday, 12th February 1796.^[303–305] She was the daughter of Josiah Betts{ XE "Betts:Josiah" \f "Name" \i } and Hannah Sherman{ XE "Sherman:Hannah" \f "Name" \i }.

Elizabeth reached 84 years of age and died in Van Buren, Onondaga County, { XE "USA, New York, Onondaga County, Van Buren:(43.1136° N, 76.3025° W):Betts, Elizabeth (1796–1880)" \f "Place" } on 19th December 1880.^[303] She was buried in Baldwinsville, Onondaga{ XE "USA, New York, Onondaga, Baldwinsville:(43.1587° N, 76.3327° W):Betts, Elizabeth (1796–1880)" \f "Place" }.^[303]

!S.P. May p.419 d. at her son James' house in Van Buren, NY

!

!Find A Grave Memorial# 51997572

Birth: Feb. 12, 1797 Baldwinsville Onondaga County New York, USA Death: Dec. 19, 1880 Van Buren Onondaga County New York, USA m. Arza Sears, August 3, 1817 Family links: Parents: Josiah Betts (1768 - 1847) Hannah Sherman Betts (1772 - 1867) Spouse: Arza Sears (1790 - 1859) Children: Rufus Sears (1819 - 1876)* James Sears (1822 - 1923)* *Calculated relationship Burial: Sears Cemetery Baldwinsville Onondaga County New York, USA Created by: BArnold Record added: May 04, 2010

More facts and events for Elizabeth Betts:

Residence: 1855 Van Buren{ XE "USA, New York, Onondaga, Van Buren:(43.1136° N, 76.3025° W):Betts, Elizabeth (1796–1880)" \f "Place" }^[304]
Relation to Head of House: Mother

Residence: 1880 Van Buren{ XE "USA, New York, Onondaga, Van Buren:(43.1136° N, 76.3025° W):Betts, Elizabeth (1796–1880)" \f "Place" }^[305]
Marital Status: Widowed; Relation to Head: Mother

Sons of Arza Sears and Elizabeth Betts:

- m I. **Rufus⁶ Sears**{ XE "Sears:Rufus (1819–1876)" \f "Name" \b } was born in Van Buren{ XE "USA, New York, Onondaga, Van Buren:(43.1136° N, 76.3025° W):Sears, Rufus (1819–1876)" \f "Place" } on 1st July 1819.^[304, 306] He died on 12th November 1876, at the age of 57. Rufus was buried in Sorrell Hill Cemetery, Van Buren{ XE "USA, New York, Onondaga, Van Buren, Sorrell Hill Cemetery: :Sears, Rufus (1819–1876)" \f "Place" }.



Rufus

More facts and events for Rufus Sears:

Residence: 1850 Van Buren{ XE "USA, New York, Onondaga, Van Buren:(43.1136° N, 76.3025° W):Sears, Rufus (1819–1876)" \f "Place" }

Residence: 1855 Van Buren{ XE "USA, New York, Onondaga, Van

³⁰⁵ Ancestry.com and The Church of Jesus Christ of Latter-day Saints, 1880 United States Federal Census (Provo, UT, USA, Ancestry.com Operations Inc, 2010), Ancestry.com, Year: 1880; Census Place: Van Buren, Onondaga, New York; Roll: 906; Family History Film: 1254906; Page: 352C; Enumeration District: 225.
[Source citation includes one media item]

³⁰⁶ Ancestry.com, New York, State Census, 1865 (Provo, UT, USA, Ancestry.com Operations, Inc., 2014), Ancestry.com, Record for Frank Sears. <http://search.ancestry.com/cgi-bin/sse.dll?db=7218&h=2075137&indiv=try>.

- Buren:(43.1136° N, 76.3025° W):Sears, Rufus (1819–1876)" \f "Place" }^[304]
 Relation to Head of House: Head
- Residence: 1855 E.D. 2, Van Buren{ XE "USA, New York, Onondaga, Van Buren, E.D. 2: :Sears, Rufus (1819–1876)" \f "Place" }
- Residence: 1860 Van Buren{ XE "USA, New York, Onondaga, Van Buren:(43.1136° N, 76.3025° W):Sears, Rufus (1819–1876)" \f "Place" }
- Residence: 1865 Van Buren{ XE "USA, New York, Onondaga, Van Buren:(43.1136° N, 76.3025° W):Sears, Rufus (1819–1876)" \f "Place" }^[306]
 Age: 45; RelationToHead: Head
- Residence: 1865 District 02, Van Buren{ XE "USA, New York, Onondaga, Van Buren, District 02: :Sears, Rufus (1819–1876)" \f "Place" }
- Census: 1870 Van Buren{ XE "USA, New York, Onondaga, Van Buren:(43.1136° N, 76.3025° W):Sears, Rufus (1819–1876)" \f "Place" }
- Residence: 1870 New York{ XE "USA, New York:(42.7531° N, 74.2224° W):Sears, Rufus (1819–1876)" \f "Place" }
- Residence: 1875 Van Buren, Onondaga, New York{ XE "USA, New York, Onondaga, Van Buren:(43.1136° N, 76.3025° W):Sears, Rufus (1819–1876)" \f "Place" }

At the age of 28, Rufus married **Jane Elizabeth Smith**{ XE "Smith:Jane Elizabeth (1824–1904)" \f "Name" \b \i } on Wednesday, 29th September 1847, when she was 22 years old.^[306] They had seven children: Frank (1848–1911), George (1850–1875), Emma (1852–1912), Arza (1853–1943), Mark (1855–1865), Adelaide (1860–1946) and Charles (1862–1946).

Jane Elizabeth was born in perh, Van Buren,{ XE "USA, New York, Onondaga, Van Buren, perh: :Smith, Jane Elizabeth (1824–1904)" \f "Place" } on Wednesday, 15th December 1824.^[306] She was the daughter of William Smith{ XE "Smith:William" \f "Name" \i } and Hannah Upson{ XE "Upson:Hannah" \f "Name" \i }.

Jane Elizabeth reached 79 years of age and died in 1904. She was buried in Baldwinsville{ XE "USA, New York, Onondaga, Baldwinsville:(43.1587° N, 76.3327° W):Smith, Jane Elizabeth (1824–1904)" \f "Place" }.

!S.P. May p.419 she lives in Baldwinsville, NY

!Find A Grave Memorial# 51993051 Birth: 1824 Death: 1904 Family links:
 Spouse: Rufus Sears (1819 - 1876)* Children: George Sears (1850 - 1875)*
 Emma Sears (1852 - 1912)* Arza Sears (1853 - 1943)* Mark Sears (1855 - 1865)*
 Adelaide Sears Dow (1860 - 1946)* *Calculated relationship Burial: Riverview
 Cemetery Baldwinsville Onondaga County New York, USA Created by: BArnold Record
 added: May 04, 2010

- m II. **James Sears**{ XE "Sears:James (1822–1923)" \f "Name" \b } was born in Van Buren{ XE "USA, New York, Onondaga, Van Buren:(43.1136° N, 76.3025° W):Sears, James (1822–1923)" \f "Place" } on 26th December 1822.^[303, 305, 307] He died in Van Buren{ XE "USA, New York, Onondaga, Van Buren:(43.1136° N, 76.3025° W):Sears, James (1822–1923)" \f "Place" } on 31st May 1923, at the age of 100.^[303] James was buried in Van Buren{ XE "USA, New York, Onondaga, Van Buren:(43.1136° N, 76.3025° W):Sears, James (1822–1923)" \f "Place" }.^[303]



James

³⁰⁷ Ancestry.com, 1920 United States Federal Census (Provo, UT, USA, Ancestry.com Operations Inc, 2010), Ancestry.com, Year: 1920; Census Place: Van Buren, Onondaga, New York; Roll: T625_1250; Page: 5B; Enumeration District: 235.

More facts and events for James Sears:

- Census: 1860 Van Buren{ XE "USA, New York, Onondaga, Van Buren:(43.1136° N, 76.3025° W):Sears, James (1822-1923)" \f "Place" }
- Residence: 1880 Van Buren{ XE "USA, New York, Onondaga, Van Buren:(43.1136° N, 76.3025° W):Sears, James (1822-1923)" \f "Place" }^[305]
Marital Status: Widower; Relation to Head: Self
- Census: 1900 Van Buren{ XE "USA, New York, Onondaga, Van Buren:(43.1136° N, 76.3025° W):Sears, James (1822-1923)" \f "Place" }
- Census: 1910 Van Buren{ XE "USA, New York, Onondaga, Van Buren:(43.1136° N, 76.3025° W):Sears, James (1822-1923)" \f "Place" }
- Census: 1920 Van Buren{ XE "USA, New York, Onondaga, Van Buren:(43.1136° N, 76.3025° W):Sears, James (1822-1923)" \f "Place" }
- Residence: 1920 Van Buren{ XE "USA, New York, Onondaga, Van Buren:(43.1136° N, 76.3025° W):Sears, James (1822-1923)" \f "Place" }^[307]
Relation to Head: Head; Residence Marital Status: Widowed

At the age of 21, James Sears married **Hannah Nichols**{ XE "Nichols:Hannah (1825-1878)" \f "Name" \b \i } on Wednesday, 28th February 1844, in Old Sorrels Hill{ XE "USA, New York, Onondaga, Old Sorrels Hill: :Sears, James (1822-1923)" \f "Place" } when she was 18 years old.^[303] They had six children: Viola (1848-1849), Fred (1850-1889), Grant (1853-1854), Mary (1855-1927), Lizzie (1861-1909) and Louis (1864-1954).

Hannah was born in Van Buren{ XE "USA, New York, Onondaga, Van Buren:(43.1136° N, 76.3025° W):Nichols, Hannah (1825-1878)" \f "Place" } on Tuesday, 12th April 1825.^[303] She was the daughter of Browning Nichols{ XE "Nichols:Browning" \f "Name" \i } and Persis Howe{ XE "Howe:Persis" \f "Name" \i }.

Hannah reached 52 years of age and died in Van Buren{ XE "USA, New York, Onondaga, Van Buren:(43.1136° N, 76.3025° W):Nichols, Hannah (1825-1878)" \f "Place" } on 2nd March 1878.^[303] She was buried in Baldwinsville{ XE "USA, New York, Onondaga, Baldwinsville:(43.1587° N, 76.3327° W):Nichols, Hannah (1825-1878)" \f "Place" }.^[303]

* JTFASEN1 * 30 Apr 2010 8:42 PM GMT Thank you for the information. I was just recording data I assumed correct written by my great aunt Persis Marie Nichols, daughter of Albert Nichols, the brother in law of James Sears. It was based on Albert's correspondence with James Sears. When I was growing up, we had photos of Mr. Sears in his old age, bald with a long, long beard, his brick house, and photos of all the graves in the family cemetery. It is the Nichols and Howe family that are buried there on Browning Nichols farm, sold to his son-in-law James Sears

!Find A Grave Memorial# 51997238 Birth: Apr. 12, 1825 Van Buren Onondaga County New York, USA Death: Mar. 2, 1878 Van Buren Onondaga County New York, USA m. James Sears, February 28, 1844 Syracuse Daily Journal March 13, 1887 WARNERS. WARNERS, March 11, 1878. The funeral of Mrs. Hannah Sears was held at the family residence on Monday, March 4th, Rev. Joseph Maxwell preaching an excellent sermon from the text, "For we know that if the tabernacle of this earthly house were dissolved, we have a building of God, a house not made with hands, eternal in the heavens." Mrs. Sears was in her fifty third year, and had suffered much for many years. For many months past she has been confined to her bed, wasted to a skeleton by consumption; and while having everything that could make earth desirable, she has been longing and praying to go to the better land. Her life was pure, and her death triumphant. Family links: Parents: Browning Nichols (1799 - 1864) Persis Howe Nichols (1801 - 1876) Spouse: James Sears (1822 - 1923) Children: Viola Sears (1848 - 1849)* Fred L. Sears (1850 -

1889)* Grant Sears (1853 - 1854)* Mary Sears (1855 - 1927)* Lizzy Sears (1861 - 1909)* Louis J Sears (1864 - 1954)* *Calculated relationship Burial: Sears Cemetery Baldwinsville Onondaga County New York, USA Maintained by: James Faasen Originally Created by: BAarnold Record added: May 04, 2010

Family of Ambrose Sears and Ruth --Sears{ TC "Ambrose Sears and Ruth --Sears" \I 3 \f C}

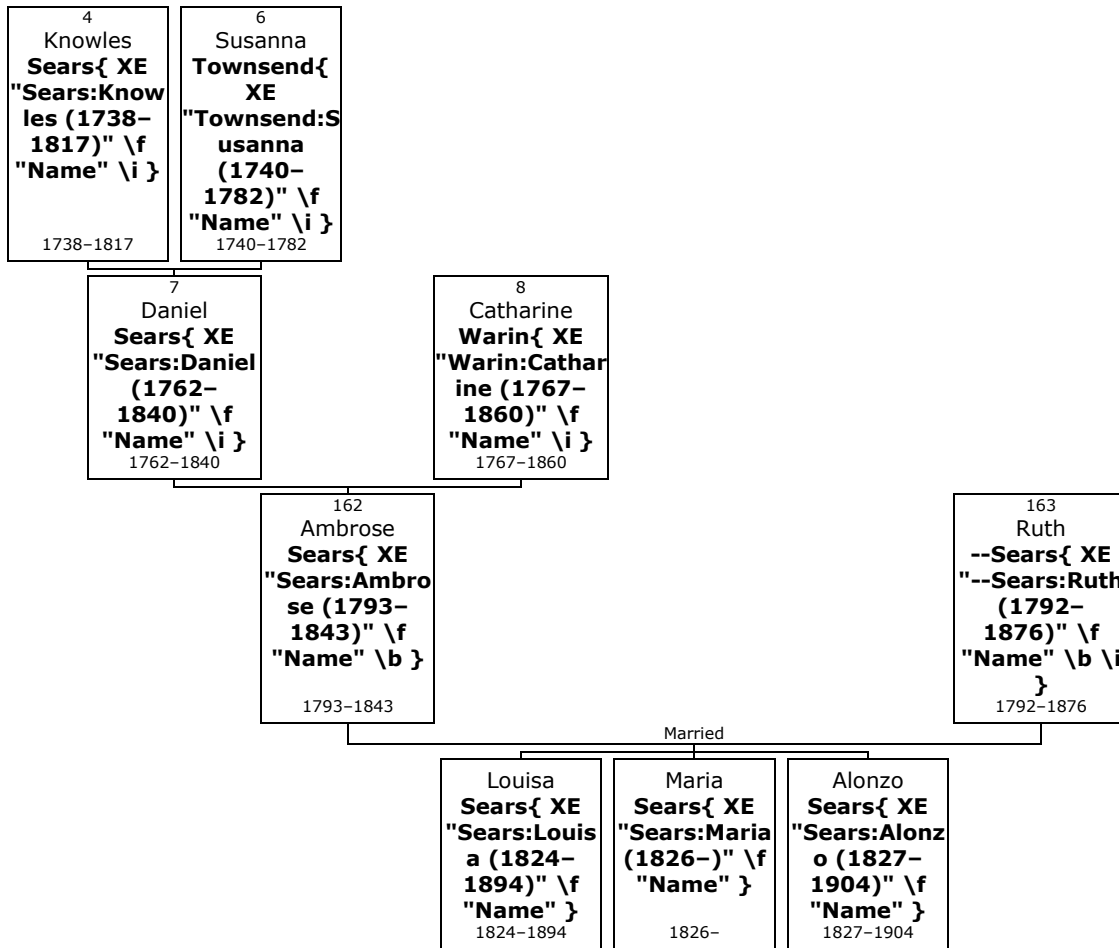

162. Ambrose⁵ Sears{ XE "Sears:Ambrose (1793-1843)" \f "Name" \b } (*Daniel⁴, Susanna³ Townsend*) was born on Saturday, 17th August 1793, in perh, Rensselaerville, Albany, New York, USA{ XE "USA, New York, Albany, Rensselaerville, perh: :Sears, Ambrose (1793-1843)" \f "Place" }. He was the son of Daniel Sears{ XE "Sears:Daniel (1762-1840)" \f "Name" \i } (7) and Catharine Warin{ XE "Warin:Catharine (1767-1860)" \f "Name" \i } (8).

Ambrose died in Ellington, Chautauqua,{ XE "USA, New York, Chautauqua, Ellington:(42.2167° N, 79.1081° W):Sears, Ambrose (1793-1843)" \f "Place" } on 9th August 1843, at the age of 49.

S P May No 1642

<https://www.wikitree.com/wiki/Sears-5698>

163. He married **Ruth --Sears**{ XE "--Sears:Ruth (1792-1876)" \f "Name" \b \i }. They had three children: Louisa (1824-1894), Maria (1826-) and Alonzo (1827-1904).

Ruth was born in perh{ XE "USA, New York, perh: :--Sears, Ruth (1792-1876)" \f "Place" } in 1792. She reached 84 years of age and died in Erie, Whiteside, Illinois,{ XE "USA, Illinois, Whiteside, Erie:(41.6564° N, 90.0793° W):--Sears, Ruth (1792-1876)" \f "Place" } on 18th June 1876. Ruth was buried. Sharon Cemetery.

!Mrs Glenn Loring

Children of Ambrose Sears and Ruth --Sears:

- f I. **Louisa⁶ Sears**{ XE "Sears:Louisa (1824-1894)" \f "Name" \b } was born in perh, New York,{ XE "USA, New York, perh: :Sears, Louisa (1824-1894)" \f "Place" } in 1824. She

died in Republic, Kansas,{ XE "USA, Kansas, Republic:(39.8282° N, 97.6503° W):Sears, Louisa (1824-1894)" \f "Place" } on 6th February 1894, at the age of 70. Louisa was buried. White Rock Cemetery (Republic Co).

More facts and events for Louisa Sears:

Residence: 1850 Ellington, Chautauqua, New York{ XE "USA, New York, Chautauqua, Ellington:(42.2167° N, 79.1081° W):Sears, Louisa (1824-1894)" \f "Place" }

Residence: 1855 Poland{ XE "USA, New York, Chautauqua, Poland:(42.1292° N, 79.1212° W):Sears, Louisa (1824-1894)" \f "Place" }

Residence: 1860 Portland, Whiteside, Illinois{ XE "USA, Illinois, Whiteside, Portland:(41.6625° N, 89.98° W):Sears, Louisa (1824-1894)" \f "Place" }

Residence: 1870 Illinois{ XE "USA, Illinois:(39.7333° N, 88.5° W):Sears, Louisa (1824-1894)" \f "Place" }

Residence: 1880 Portland, Whiteside, Illinois{ XE "USA, Illinois, Whiteside, Portland:(41.6625° N, 89.98° W):Sears, Louisa (1824-1894)" \f "Place" }

Louisa married **Albert Ocobock**{ XE "Ocobock:Albert (1815-1882)" \f "Name" \b \i }. They had six children: James (1841-1905), George (1843-1864), Juliette (1845-), Maria (1847-), Alonzo (1849-) and Willie (1851-).

Albert was born in New York{ XE "USA, New York:(42.7531° N, 74.2224° W):Ocobock, Albert (1815-1882)" \f "Place" } in 1815. He died in Republic, Kansas,{ XE "USA, Kansas, Republic:(39.8282° N, 97.6503° W):Ocobock, Albert (1815-1882)" \f "Place" } between 1882 and 1883. Albert was buried. White Rock Cemetery, Republic Co.

!Mrs Glenn Loring

<http://www.sprague-database.org/genealogy/getperson.php?personID=I143891> d. Between Aug 1881 and 12 Sep 1881

f II. **Maria Sears**{ XE "Sears:Maria (1826-)" \f "Name" \b } was born in New York{ XE "USA, New York:(42.7531° N, 74.2224° W):Sears, Maria (1826-)" \f "Place" } in 1826.

Maria married **Horace Coe**{ XE "Coe:Horace" \f "Name" \b \i }.

m III. **Alonzo Sears**{ XE "Sears:Alonzo (1827-1904)" \f "Name" \b } was born in Steuben, New York,{ XE "USA, New York, Steuben:(42.2642° N, 77.3854° W):Sears, Alonzo (1827-1904)" \f "Place" } on 18th May 1827.^[308] He died in 1904 at the age of 76. Alonzo was buried in Sherer Cemetery{ XE "USA, New York, Steuben, Sherer Cemetery: :Sears, Alonzo (1827-1904)" \f "Place" }.

More facts and events for Alonzo Sears:

Residence: 1865 Cameron{ XE "USA, New York, Steuben, Cameron:(42.1992° N, 77.4067° W):Sears, Alonzo (1827-1904)" \f "Place" }^[308]

Relation to Head of House: Head

Alonzo married **Maria Hotchkiss**{ XE "Hotchkiss:Maria" \f "Name" \b \i }.

Alonzo married **Henrietta Margaret --Sears**{ XE "--Sears:Henrietta Margaret (1830-1892)" \f "Name" \b \i }.^[308] They had one son: Charles (1855-1901).

Henrietta Margaret was born on Thursday, 1st April 1830.^[308] She reached 61 years of age and died in 1892.

!Find A Grave Memorial# 67892535

Birth: Apr. 1, 1830 Death: 1913 Family links: Spouse: Alonzo Sears (1827 - ____)

³⁰⁸ Ancestry.com, New York, State Census, 1865 (Provo, UT, USA, Ancestry.com Operations, Inc., 2014), Ancestry.com.

Burial: Sherer Cemetery Steuben County New York, USA Created by: caroline Record added: Apr 04, 2011

Family of Ahiram Sears and Ann Bell{ TC "Ahiram Sears and Ann Bell" \I 3 \f C}

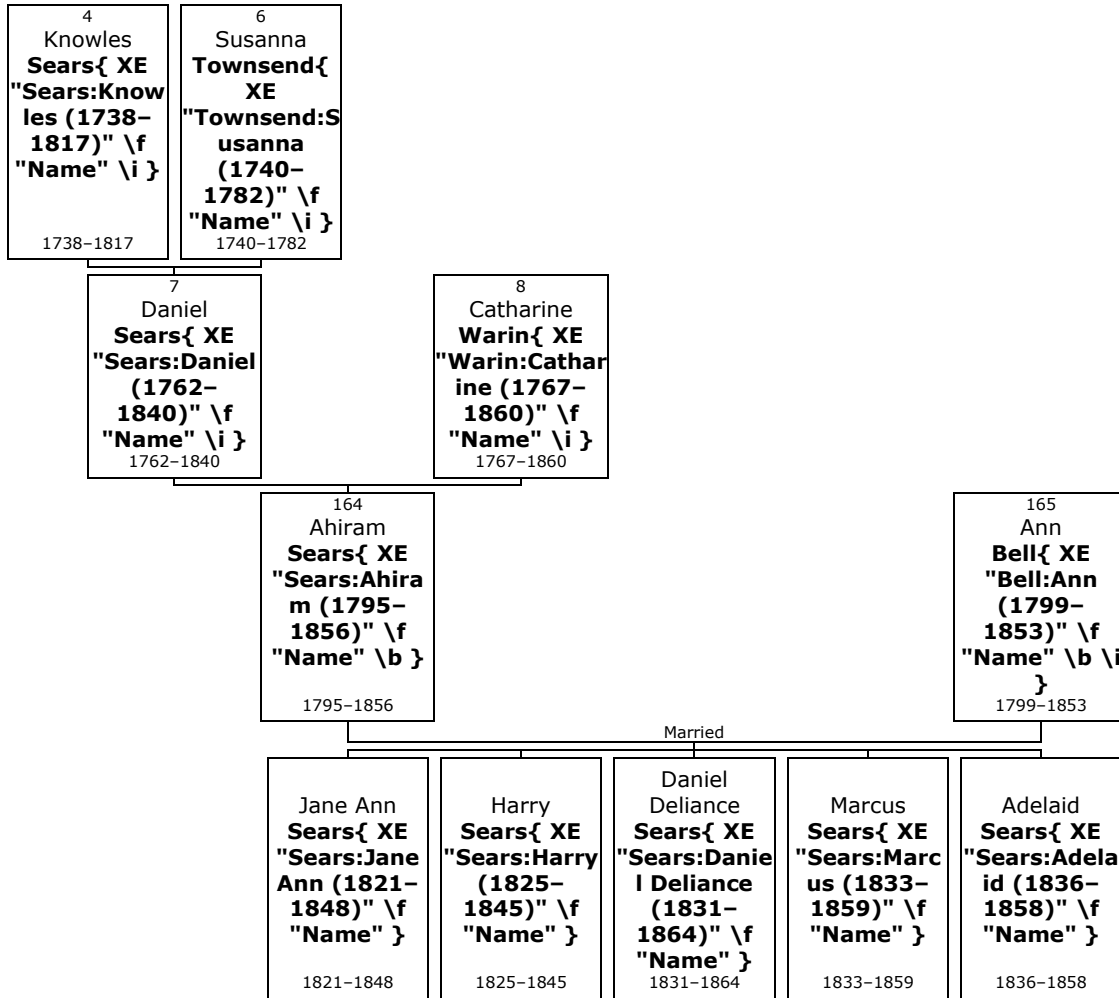

164. Ahiram⁵ Sears{ XE "Sears:Ahiram (1795-1856)" \f "Name" \b } (*Daniel⁴, Susanna³ Townsend*) was born on Sunday, 5th April 1795, in perh, Rensselaerville, Albany, New York, USA{ XE "USA, New York, Albany, Rensselaerville, perh: :Sears, Ahiram (1795-1856)" \f "Place" }.^[309, 310] He was the son of Daniel Sears{ XE "Sears:Daniel (1762-1840)" \f "Name" \i } (7) and Catharine Warin{ XE "Warin:Catharine (1767-1860)" \f "Name" \i } (8).

Ahiram died in Baldwinsville{ XE "USA, New York, Onondaga, Baldwinsville:(43.1587° N, 76.3327° W):Sears, Ahiram (1795-1856)" \f "Place" } on 9th April 1856, at the age of 61.^[310] He was buried in Myrtle Grove Cemetery, Lysander{ XE "USA, New York, Onondaga, Lysander, Myrtle Grove Cemetery: :Sears, Ahiram (1795-1856)" \f "Place" }.^[310]

!S.P. May No 1643 p.419 Ahiram Sears removed about 1838, to the vicinity of Baldwinsville, NY, where he and his wife and children died, and are buried.

!
<https://www.wikitree.com/wiki/Sears-5699>

!Find A Grave Memorial# 65285800

³⁰⁹ Ancestry.com, New York, State Census, 1855 (Provo, UT, USA, Ancestry.com Operations, Inc., 2013), Ancestry.com, Record for Marcus Sears. <http://search.ancestry.com/cgi-bin/sse.dll?db=7181&h=1655401430&indiv=try>. [Source citation includes one media item]

³¹⁰ Ancestry.com, U.S., Find A Grave Index, 1600s-Current (Provo, UT, USA, Ancestry.com Operations, Inc., 2012), Ancestry.com.

Birth: Apr. 3, 1795 Death: Apr. 9, 1856 ae 61 yr, 6 days. Family links: Parents: Daniel Sears (1762 - 1840) Catherine Warin Sears (1767 - 1860) Spouse: Anna Bell Sears (1799 - 1853)* Children: Jane Ann Sears (____ - 1848)* Harry Sears (____ - 1845)* *Calculated relationship Burial: Myrtle Grove Cemetery Lysander Onondaga County New York, USA Created by: BArnold Record added: Feb 06, 2011

FindAGrave=Name: Jane Ann Sears Death Date: 11 May 1848 Burial Place: Lysander, Onondaga County, New York, USA Birth: unknown Death: May 11, 1848 ae 26 yr 7 mo 5 days, dau of Ahiram and Anna Sears. Family links: Parents:Ahiram Sears (1795 - 1856) Anna Bell Sears (1799 - 1853) Burial:Myrtle Grove Cemetery Lysander Onondaga CountyNew York, USA Lewis William Sears 1828 - 1831

!

!Ancestry also shows Clarinda Sears 1820 ? 1825 Jane Anne Sears 1821 - 1848

!

!1850 United States Federal Census <http://www.ancestry.com/search/db.aspx?dbid=8054> Name: Ahiram Sears Age: 53 Estimated birth year: abt 1797 Birth Place: New York Gender: Male Home in 1850 (City,County,State): Lysander, Onondaga, New York Family Number: 897

Household Members: Name Age

Ahiram Sears 53

Anna Sears 51

Daniel Sears 19

Marcus Sears 17

Adelaid Sears 14

Alfred Sears 62

Robert Bell 18

Elen Hewett 19

John Boom 25

More facts and events for Ahiram Sears:

Residence: 1855 Lysander{ XE "USA, New York, Onondaga, Lysander:(43.2064° N, 76.4594° W):Sears, Ahiram (1795-1856)" \f "Place" }^[309]
Age: 59; RelationToHead: Head

165. He married **Ann Bell**{ XE "Bell:Ann (1799-1853)" \f "Name" \b \i }.^[310] They had five children: Jane (1821-1848), Harry (1825-1845), Daniel (1831-1864), Marcus (1833-1859) and Adelaid (1836-1858).

Ann was born in perh, Baldwinsville,{ XE "USA, New York, Onondaga, Baldwinsville, perh: :Bell, Ann (1799-1853)" \f "Place" } on Wednesday, 4th December 1799.^[310] She reached 53 years of age and died in Baldwinsville{ XE "USA, New York, Onondaga, Baldwinsville:(43.1587° N, 76.3327° W):Bell, Ann (1799-1853)" \f "Place" } on 5th April 1853.^[310] Ann was buried in Lysander{ XE "USA, New York, Onondaga, Lysander:(43.2064° N, 76.4594° W):Bell, Ann (1799-1853)" \f "Place" }.^[310]

!Find A Grave Memorial# 65285830

Birth: Dec. 4, 1799 Death: Apr. 5, 1853 ae 53 yr 4 mo 1 day. Wife of Ahiram Sears. Family links: Spouse: Ahiram Sears (1795 - 1856) Children: Jane Ann Sears (____ - 1848)* Harry Sears (____ - 1845)* *Calculated relationship Burial: Myrtle Grove Cemetery Lysander Onondaga County New York, USA Created by: BArnold Record added: Feb 06, 2011

Children of Ahiram Sears and Ann Bell:

f I. **Jane Ann⁶ Sears**{ XE "Sears:Jane Ann (1821-1848)" \f "Name" \b } was born in 1821. She died in 1848 at the age of 27.



Jane

m II. **Harry Sears**{ XE "Sears:Harry (1825-1845)" \f "Name" \b } was born in 1825. He died on 12th December 1845, at the age of 20.

m III. **Daniel Deliance Sears**{ XE "Sears:Daniel Deliance (1831-1864)" \f "Name" \b } was born in Baldwinsville{ XE "USA, New York, Onondaga, Baldwinsville:(43.1587° N, 76.3327° W):Sears, Daniel Deliance (1831-1864)" \f "Place" } in 1831.^[310, 311-312] He died in Baldwinsville{ XE "USA, New York, Onondaga, Baldwinsville:(43.1587° N, 76.3327° W):Sears, Daniel Deliance (1831-1864)" \f "Place" } on 26th January 1864, at the age of 33.^[310, 312] Daniel Deliance was buried in Clay, Onondaga County{ XE "USA, New York, Onondaga County, Clay:(43.1858° N, 76.1728° W):Sears, Daniel Deliance (1831-1864)" \f "Place" }.^[310] His estate was probated on 9th September 1864, in Onondaga{ XE "USA, New York, Onondaga:(43.2291° N, 76.1427° W):Sears, Daniel Deliance (1831-1864)" \f "Place" }.^[312]



Daniel

More facts and events for Daniel Deliance Sears:

Residence: 1855 Lysander, Onondaga{ XE "USA, New York, Onondaga, Lysander:(43.2064° N, 76.4594° W):Sears, Daniel Deliance (1831-1864)" \f "Place" }.^[311]
 Relation to Head of House: Head

Daniel Deliance married **Harriet Amelia Wilcox**{ XE "Wilcox:Harriet Amelia" \f "Name" \b \i }.

Daniel Deliance married **Emily Hopkins Wilcox**{ XE "Wilcox:Emily Hopkins (1831-1859)" \f "Name" \b \i }.^[310, 311] They had four children: Anna (1852-), Harriet (ca.1853-1856), Fred. (1854-) and Arthur (1857-1936).

Emily Hopkins was born in perh, Baldwinsville,{ XE "USA, New York, Onondaga, Baldwinsville, perh: :Wilcox, Emily Hopkins (1831-1859)" \f "Place" } in 1831.^[310, 311] She reached 28 years of age and died on 1st March 1859.^[310] Emily Hopkins was buried in Pine Plains Cemetery, Clay{ XE "USA, New York, Onondaga, Clay, Pine Plains Cemetery: :Wilcox, Emily Hopkins (1831-1859)" \f "Place" }.^[310]

Birth: 1831 Death: Mar. 1, 1859 Family links: Children: Harriet Sears (____ - 1856)* *Calculated relationship Inscription: Wife of Daniel D. Sears Burial: Pine Plains Cemetery Clay Onondaga County New York, USA Edit Virtual Cemetery info [?] Created by: af Record added: Oct 15, 2009 Find A Grave Memorial# 43155677

m IV. **Marcus Sears**{ XE "Sears:Marcus (1833-1859)" \f "Name" \b } was born in Baldwinsville{ XE "USA, New York, Onondaga, Baldwinsville:(43.1587° N, 76.3327° W):Sears, Marcus (1833-1859)" \f "Place" } in 1833.^[309, 310, 313] He died in Baldwinsville{ XE "USA, New York, Onondaga, Baldwinsville:(43.1587° N, 76.3327° W):Sears, Marcus (1833-1859)" \f "Place" } on 18th July 1859, at the age of 26.^[310, 313] Marcus was buried in Myrtle Grove Cemetery, Lysander{ XE "USA, New York, Onondaga, Lysander, Myrtle Grove Cemetery: :Sears, Marcus (1833-1859)" \f "Place" }.^[310] His estate was probated on 8th August 1859, in Onondaga{ XE "USA, New York, Onondaga:(43.2291° N, 76.1427° W):Sears, Marcus (1833-1859)" \f "Place" }.^[313]



Marcus

More facts and events for Marcus Sears:

Residence: 1855 Lysander, Onondaga{ XE "USA, New York, Onondaga, Lysander:(43.2064° N, 76.4594° W):Sears, Marcus (1833-1859)" \f "Place" }.^[309]
 Age: 22; RelationToHead: Son

³¹¹ Ancestry.com, New York, State Census, 1855 (Provo, UT, USA, Ancestry.com Operations, Inc., 2013), Ancestry.com.

³¹² Ancestry.com, New York, Wills and Probate Records, 1659-1999 (Provo, UT, USA, Ancestry.com Operations, Inc., 2015), Ancestry.com, Miscellaneous Orders and Decrees, 1821-1868; Author: New York. Surrogate's Court (Onondaga County); Probate Place: Onondaga, New York.

³¹³ Ancestry.com, New York, Wills and Probate Records, 1659-1999 (Provo, UT, USA, Ancestry.com Operations, Inc., 2015), Ancestry.com, Wills, 1796-1867; Author: New York. Surrogate's Court (Onondaga County); Probate Place: Onondaga, New York.

Marcus Sears married **Prudence M --Sears**{ XE "--Sears:Prudence M (1834–1860)" \f "Name" \b \i }.^[310, 314] They had one son: Ernest (1858–1859).

Prudence M was born on Monday, 16th June 1834.^[310] She reached 25 years of age and died on 16th January 1860.^[310, 314] Prudence M was buried in Myrtle Grove Cemetery, Lysander{ XE "USA, New York, Onondaga, Lysander, Myrtle Grove Cemetery: :--Sears, Prudence M (1834–1860)" \f "Place" }.^[310] Her estate was probated on 5th March 1860, in Onondaga{ XE "USA, New York, Onondaga:(43.2291° N, 76.1427° W):--Sears, Prudence M (1834–1860)" \f "Place" }.^[314]

Birth: unknown Death: Jan. 16, 1860 ae 25 yr 7 mo. Wife of M Sears. Family links:
Spouse: Marcus Sears (____ - 1859) Children: Ernest M Sears (____ - 1859)*
*Calculated relationship Burial: Myrtle Grove Cemetery Lysander Onondaga County
New York, USA Edit Virtual Cemetery info [?] Created by: BArnold Record added: Feb
06, 2011 Find A Grave Memorial# 65285985

- f V. **Adelaid Sears**{ XE "Sears:Adelaid (1836–1858)" \f "Name" \b } was born in Baldwinsville{ XE "USA, New York, Onondaga, Baldwinsville:(43.1587° N, 76.3327° W):Sears, Adelaid (1836–1858)" \f "Place" } in 1836. She died in Baldwinsville{ XE "USA, New York, Onondaga, Baldwinsville:(43.1587° N, 76.3327° W):Sears, Adelaid (1836–1858)" \f "Place" } on 16th July 1858, at the age of 22. Adelaid was buried in Myrtle Grove Cemetery, Lysander{ XE "USA, New York, Onondaga, Lysander, Myrtle Grove Cemetery: :Sears, Adelaid (1836–1858)" \f "Place" }.

³¹⁴ Ancestry.com, New York, Wills and Probate Records, 1659-1999 (Provo, UT, USA, Ancestry.com Operations, Inc., 2015), Ancestry.com, Letters Testamentary and Letters of Administration 1830-1866; Author: New York. Surrogate's Court (Onondaga County); Probate Place: Onondaga, New York. Record for Prudence M Sears.
<http://search.ancestry.com/cgi-bin/sse.dll?db=8800&h=2879268&indiv=try>.
[Source citation includes one media item]

Family of Ruhamah Sears and Judge Barager{ TC "Ruhamah Sears and Judge Barager" \I 3 \f C}

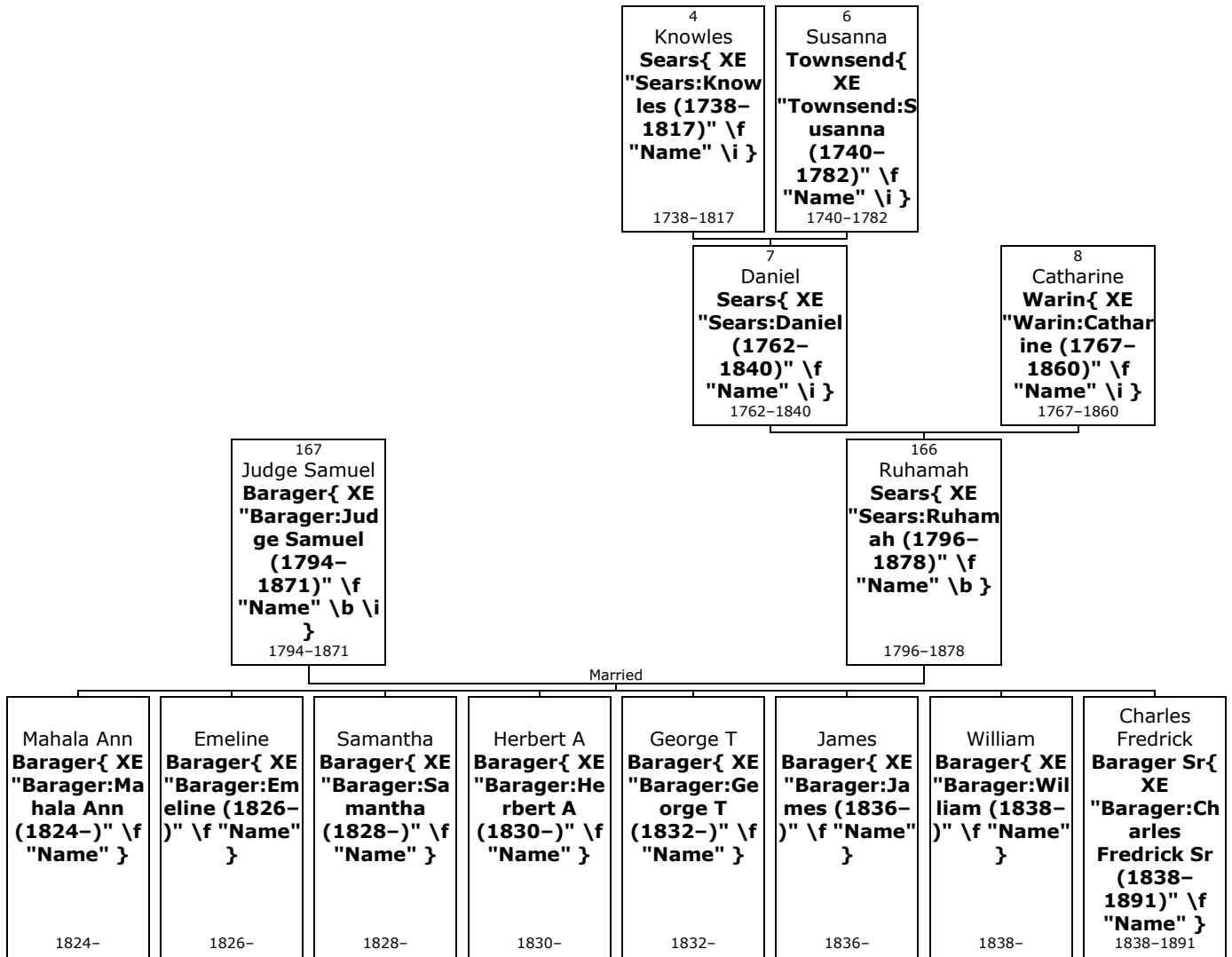

166. Ruhamah⁵ Sears{ XE "Sears:Ruhamah (1796-1878)" \f "Name" \b } (*Daniel⁴, Susanna³ Townsend*) was born on Thursday, 22nd December 1796, in perh, Rensselaerville, Albany, New York, USA{ XE "USA, New York, Albany, Rensselaerville, perh: :Sears, Ruhamah (1796-1878)" \f "Place" }.^[315, 316] She was the daughter of Daniel Sears{ XE "Sears:Daniel (1762-1840)" \f "Name" \i } (7) and Catharine Warin{ XE "Warin:Catharine (1767-1860)" \f "Name" \i } (8).

Ruhamah died in Candor{ XE "USA, New York, Tioga, Candor:(42.2329° N, 76.3425° W):Sears, Ruhamah (1796-1878)" \f "Place" } on 4th April 1878, at the age of 81.^[316] She was buried in Candor{ XE "USA, New York, Tioga, Candor:(42.2329° N, 76.3425° W):Sears, Ruhamah (1796-1878)" \f "Place" }.^[316]

!S.P. May No 1644 p.275 rem. to Candor, NY

<https://www.wikitree.com/wiki/Sears-5700>

More facts and events for Ruhamah Sears:

Residence: 1865 Candor{ XE "USA, New York, Tioga, Candor:(42.2329° N, 76.3425° W):Sears, Ruhamah (1796-1878)" \f "Place" }^[315]

³¹⁵ Ancestry.com, New York, State Census, 1865 (Provo, UT, USA, Ancestry.com Operations, Inc., 2014), Ancestry.com, Record for Charles F Barager. <http://search.ancestry.com/cgi-bin/sse.dll?db=7218&h=1284516&indiv=try>. [Source citation includes one media item]

³¹⁶ Ancestry.com, U.S., Find A Grave Index, 1600s-Current (Provo, UT, USA, Ancestry.com Operations, Inc., 2012), Ancestry.com, Record for Capt Charles Fredrick Sr Barager. <http://search.ancestry.com/cgi-bin/sse.dll?db=60525&h=81239694&indiv=try>.

Age: 66; RelationToHead: Wife

- 167.** She married **Judge Samuel Barager**{ XE "Barager:Judge Samuel (1794–1871)" \f "Name" \b i }.^[315, 316] They had eight children: Mahala (1824–), Emeline (1826–), Samantha (1828–), Herbert (1830–), George (1832–), James (1836–), William (1838–) and Charles (1838–1891).

Judge Samuel was born in New York{ XE "USA, New York:(42.7531° N, 74.2224° W):Barager, Judge Samuel (1794–1871)" \f "Place" } in 1794.^[315, 316] He reached 77 years of age and died in Candor{ XE "USA, New York, Tioga, Candor:(42.2329° N, 76.3425° W):Barager, Judge Samuel (1794–1871)" \f "Place" } on 27th April 1871.^[316] Judge Samuel was buried in Candor{ XE "USA, New York, Tioga, Candor:(42.2329° N, 76.3425° W):Barager, Judge Samuel (1794–1871)" \f "Place" }.^[316]

More facts and events for Judge Samuel Barager:

Residence: 1865 Candor{ XE "USA, New York, Tioga, Candor:(42.2329° N, 76.3425° W):Barager, Judge Samuel (1794–1871)" \f "Place" }.^[315]
Age: 69; RelationToHead: Head

Children of Ruhamah Sears and Judge Samuel Barager:

- f I. **Mahala Ann⁶ Barager**{ XE "Barager:Mahala Ann (1824–)" \f "Name" \b } was born in 1824.
- f II. **Emeline Barager**{ XE "Barager:Emeline (1826–)" \f "Name" \b } was born in 1826.
- f III. **Samantha Barager**{ XE "Barager:Samantha (1828–)" \f "Name" \b } was born in 1828.
- m IV. **Herbert A Barager**{ XE "Barager:Herbert A (1830–)" \f "Name" \b } was born in 1830.
- m V. **George T Barager**{ XE "Barager:George T (1832–)" \f "Name" \b } was born in 1832.
- m VI. **James Barager**{ XE "Barager:James (1836–)" \f "Name" \b } was born in 1836.
- m VII. **William Barager**{ XE "Barager:William (1838–)" \f "Name" \b } was born in 1838.
- m VIII. **Charles Fredrick Barager Sr**{ XE "Barager:Charles Fredrick Sr (1838–1891)" \f "Name" \b } was born in Candor{ XE "USA, New York, Tioga, Candor:(42.2329° N, 76.3425° W):Barager, Charles Fredrick Sr (1838–1891)" \f "Place" } on 5th December 1838.^[315–317] He was known by the title of Capt.

Charles Fredrick died in Candor{ XE "USA, New York, Tioga, Candor:(42.2329° N, 76.3425° W):Barager, Charles Fredrick Sr (1838–1891)" \f "Place" } on 23rd December 1891, at the age of 53.^[316] He was buried in Candor{ XE "USA, New York, Tioga, Candor:(42.2329° N, 76.3425° W):Barager, Charles Fredrick Sr (1838–1891)" \f "Place" }.^[316]

More facts and events for Charles Fredrick Barager Sr:

Residence: 1865 Candor{ XE "USA, New York, Tioga, Candor:(42.2329° N, 76.3425° W):Barager, Charles Fredrick Sr (1838–1891)" \f "Place" }.^[315]
Age: 26; RelationToHead: Son

At the age of 28, Charles Fredrick married **Mary Jane Markell**{ XE "Markell:Mary Jane (1846–1924)" \f "Name" \b i } on Wednesday, 18th September 1867, in St Louis, Missouri,{ XE "USA, Missouri, St Louis:(38.6794° N, 90.3916° W):Barager, Charles Fredrick Sr (1838–1891)" \f "Place" } when she was 20 years old.^[316, 317] They had three children: Charles (1871–1879), Vida (1880–1918) and Ruhamah.

Mary Jane was born in New Brunswick, Canada,{ XE "Canada, New Brunswick:(46.3658° N, 66.137° W):Markell, Mary Jane (1846–1924)" \f "Place" } on Saturday, 24th October 1846.^[316] She reached 77 years of age and died in Binghamton, Broome, New York, USA,{ XE "USA, New York, Broome, Binghamton:(42.0987° N, 75.918° W):Markell, Mary Jane (1846–1924)" \f "Place" } on 17th June 1924.^[316] Mary Jane was buried in

³¹⁷ Ancestry.com, Missouri, Marriage Records, 1805–2002 (Provo, UT, USA, Ancestry.com Operations, Inc., 2007), Ancestry.com, Missouri State Archives; Jefferson City, MO, USA; Missouri Marriage Records [Microfilm]. Record for Charles F Barager. <http://search.ancestry.com/cgi-bin/sse.dll?db=1171&h=10143712&indiv=try>.

Candor, Tioga{ XE "USA, New York, Tioga, Candor:(42.2329° N, 76.3425° W):Markell, Mary Jane (1846–1924)" \f "Place" }.^[316]

Family of Rufus Sears and Amanda Townsend{ TC "Rufus Sears and Amanda Townsend" \I 3 \f C}

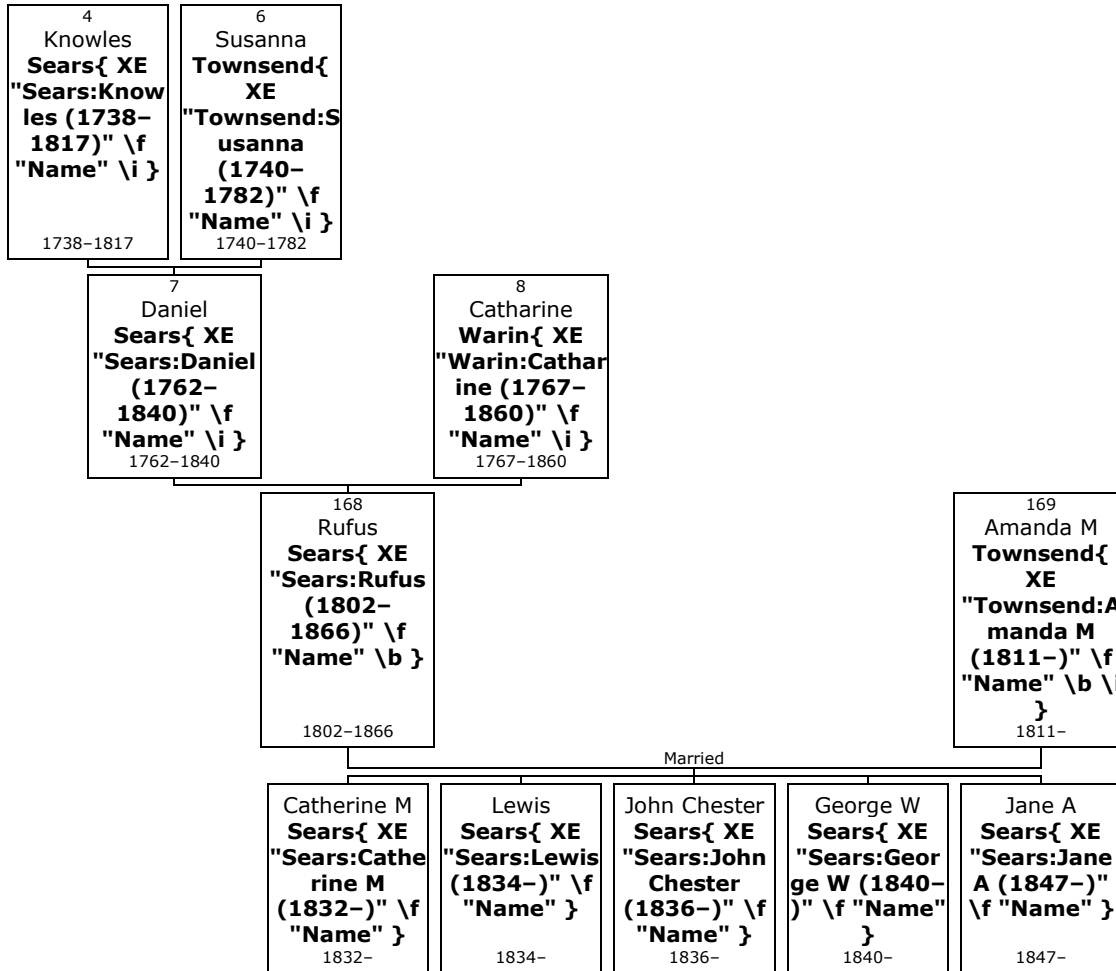

168. Rufus⁵ Sears{ XE "Sears:Rufus (1802–1866)" \f "Name" \b } (*Daniel⁴, Susanna³ Townsend*) was born on Thursday, 2nd September 1802, in perh, Rensselaerville, Albany, New York, USA{ XE "USA, New York, Albany, Rensselaerville, perh: :Sears, Rufus (1802–1866)" \f "Place" }. He was the son of Daniel Sears{ XE "Sears:Daniel (1762–1840)" \f "Name" \i } (7) and Catharine Warin{ XE "Warin:Catharine (1767–1860)" \f "Name" \i } (8).

Rufus died on 26th November 1866, at the age of 64.

!S.P. May No 1646 p.275 rem. to Schoharie, NY, thence to Susquehanna, PA, and in 1854, to Crown Point, Lake co., IN

!
<https://www.wikitree.com/wiki/Sears-5702>

!1850 United States Federal Census <http://www.ancestry.com/search/db.aspx?dbid=8054> Name: Rufus Sears Age: 44 Estimated birth year: abt 1806 Birth Place: New York Gender: Male Home in 1850(City,County,State): Bridgewater, Susquehanna, Pennsylvania Family Number: 204 Household Members: Name Age Rufus Sears 44 Amanda Sears 39 Catherine M Sears 18 Lewis Sears 16 John Chester Sears 14 Geo W Sears 10 Jane A Sears 3 !

!1860 United States Federal Census about Rufus Sears Name: Rufus Sears Age in 1860: 59 Birth Year: abt 1801 Birthplace: New York Home in 1860: Center, Lake, Indiana Gender: Male Post Office: Crown Point Value of real estate: View image Household Members: Name Age Rufus Sears 59 Amanda M Sears 53 George Sears 17 A James Sears 10

169. He married **Amanda M Townsend**{ XE "Townsend:Amanda M (1811-)" \f "Name" \b \i }. They had five children: Catherine (1832-), Lewis (1834-), John (1836-), George (1840-) and Jane (1847-).

Amanda M was born in New York{ XE "USA, New York:(42.7531° N, 74.2224° W):Townsend, Amanda M (1811-)" \f "Place" } in 1811.

!S.P. May p.275 Sister of Benajah Townsend

Children of Rufus Sears and Amanda M Townsend:

- f I. **Catherine M⁶ Sears**{ XE "Sears:Catherine M (1832-)" \f "Name" \b } was born in New York{ XE "USA, New York:(42.7531° N, 74.2224° W):Sears, Catherine M (1832-)" \f "Place" } in 1832.
- m II. **Lewis Sears**{ XE "Sears:Lewis (1834-)" \f "Name" \b } was born in New York{ XE "USA, New York:(42.7531° N, 74.2224° W):Sears, Lewis (1834-)" \f "Place" } in 1834.
- m III. **John Chester Sears**{ XE "Sears:John Chester (1836-)" \f "Name" \b } was born in New York{ XE "USA, New York:(42.7531° N, 74.2224° W):Sears, John Chester (1836-)" \f "Place" } in 1836.
- m IV. **George W Sears**{ XE "Sears:George W (1840-)" \f "Name" \b } was born in New York{ XE "USA, New York:(42.7531° N, 74.2224° W):Sears, George W (1840-)" \f "Place" } in 1840.
- f V. **Jane A Sears**{ XE "Sears:Jane A (1847-)" \f "Name" \b } was born in New York{ XE "USA, New York:(42.7531° N, 74.2224° W):Sears, Jane A (1847-)" \f "Place" } in 1847.

Family of Maria Sears and Asa Bushnell{ TC "Maria Sears and Asa Bushnell" \I 3 \f C}

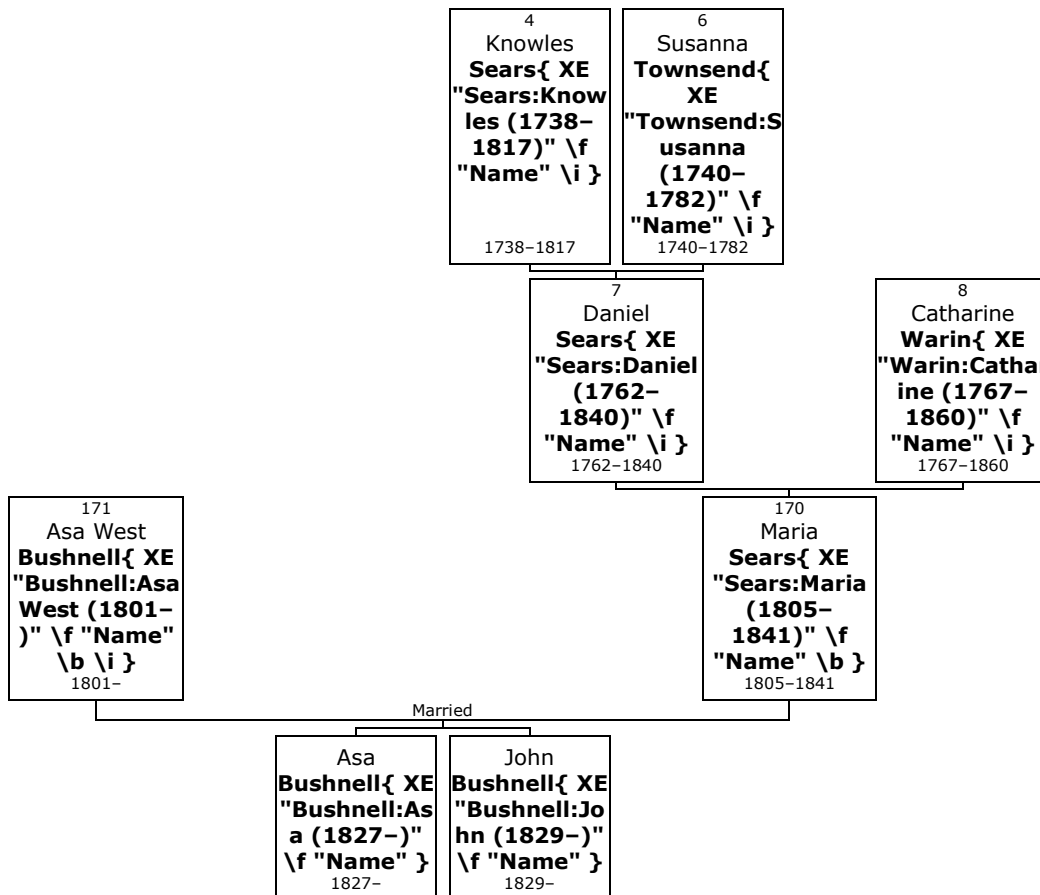

170. Maria⁵ Sears{ XE "Sears: Maria (1805–1841)" \f "Name" \b } (*Daniel⁴, Susanna³ Townsend*) was born on Friday, 1st March 1805, in perh, Rensselaerville, Albany, New York, USA{ XE "USA, New York, Albany, Rensselaerville, perh: :Sears, Maria (1805–1841)" \f "Place" }. She was the daughter of Daniel Sears{ XE "Sears: Daniel (1762–1840)" \f "Name" \i } (7) and Catharine Warin{ XE "Warin: Catharine (1767–1860)" \f "Name" \i } (8).

Maria died in Le Roy, Calhoun, Michigan,{ XE "USA, Michigan, Calhoun, Le Roy:(44.0382° N, 85.4526° W):Sears, Maria (1805–1841)" \f "Place" } on 19th October 1841, at the age of 36.

!S.P. May No 1647 p.276 Rem. to Le Roy, Calhoun co., MI, in 1840.

<https://www.wikitree.com/wiki/Sears-5703>

171. She married **Asa West Bushnell**{ XE "Bushnell: Asa West (1801–)" \f "Name" \b \i }. They had two sons: Asa (1827–) and John (1829–).

Asa West was born in perh, Le Roy, Calhoun Co.,{ XE "USA, Michigan, Calhoun Co., Le Roy, perh: :Bushnell, Asa West (1801–)" \f "Place" } in 1801.

!S.P. May p.276 A presbyterian minister

Sons of Maria Sears and Asa West Bushnell:

- m I. **Asa⁶ Bushnell**{ XE "Bushnell: Asa (1827–)" \f "Name" \b } was born in perh{ XE "USA, Michigan, Calhoun Co., Le Roy, perh: :Bushnell, Asa (1827–)" \f "Place" } in 1827.
- m II. **John Bushnell**{ XE "Bushnell: John (1829–)" \f "Name" \b } was born in perh{ XE "USA, Michigan, Calhoun Co., Le Roy, perh: :Bushnell, John (1829–)" \f "Place" } in 1829.

Family of George Hawley and Matilda Warner{ TC "George Hawley and Matilda Warner" \I 3 \f C}

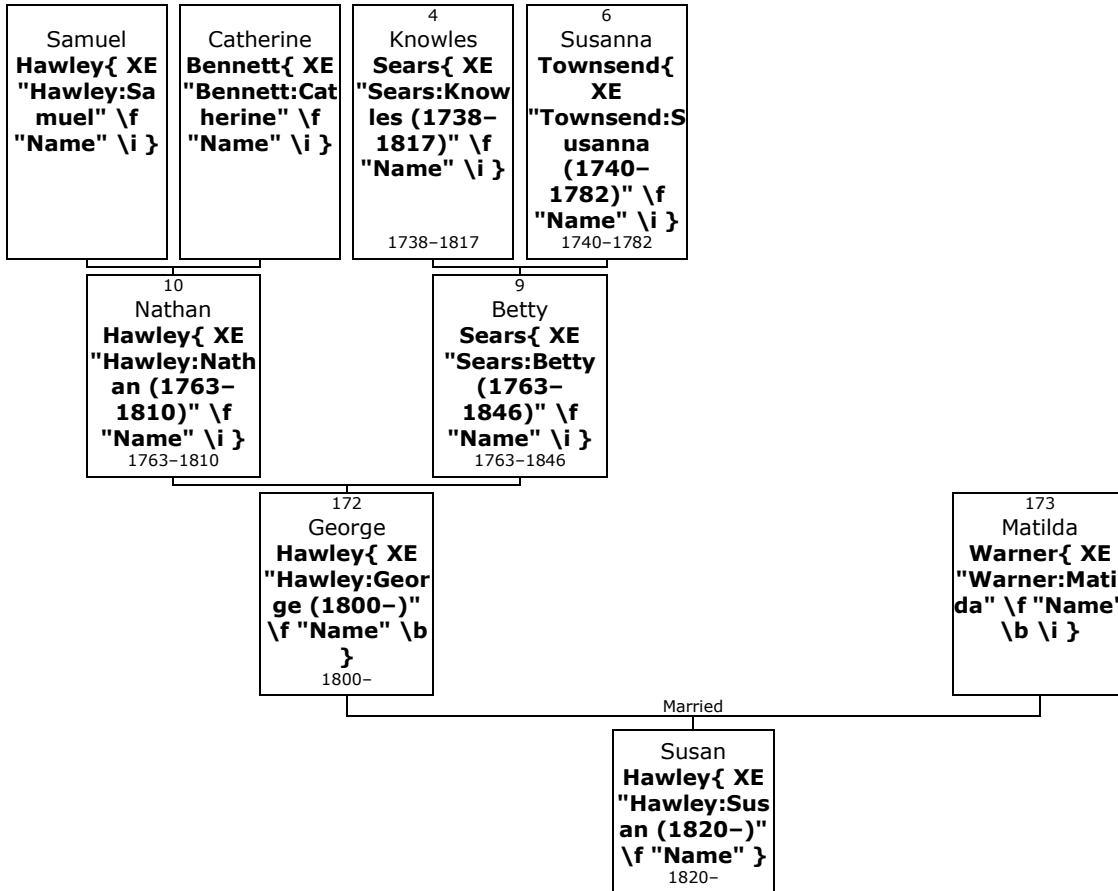

172. George⁵ Hawley{ XE "Hawley: George (1800–)" \f "Name" \b } (*Betty⁴ Sears, Susanna³ Townsend*) was born on Saturday, 12th July 1800, in perh, Ridgefield, Fairfield, Connecticut, USA{ XE "USA, Connecticut, Fairfield, Ridgefield, perh: :Hawley, George (1800–)" \f "Place" }. He was the son of Nathan Hawley{ XE

"Hawley:Nathan (1763-1810)" \f "Name" \i } (10) and Betty Sears{ XE "Sears:Betty (1763-1846)" \f "Name" \i } (9).

!S.P. May p.177 Prest. Bank, Baldwinsville, NY

From: Arnolds [mailto:barnold@twcny.rr.com] Sent: Saturday, July 30, 2005 12:53 PMTo: LRSEARS@CAPECOD.NETCc: ray.sears@halliburton.com

!Subject: 1997 Elizabeth (Sears) Hawley My name is Benjamin Arnold. I was researching Caption Knowles Sears when i came across your Sears site. I noticed the e-mail you had received from Canada. I have a black and white digital image of the watercolor "Nathan Hawley and Family" by Wendell Willkie if either of you are interested. The child on Elizabeth (Sears) Hawley's lap is No 8 or George Hawley, my 4x great grandfather. Recently my uncle showed me a very old and abandoned 'Sears Cemetery on Sorell Hill road in Onondaga county (Where we still live after nearly 200 years) where many of our Sears cousins are buried. I have some digital photos of the Sears there and their names. Stones are very worn but i would be happy to pass them along of you are interested. Thanks for posting the information about Knowles Sears military service. in case you were interested Elizabeth (Sears) Hawley George Hawley Susan (Hawley) Arnold Frederic Arnold James Irza Arnold Albert Arnold James Kaple Arnold Benjamin Arnold

173. He married **Matilda Warner**{ XE "Warner:Matilda" \f "Name" \b \i }. They had one daughter: Susan (1820-).

Daughter of George Hawley and Matilda Warner:

f I. **Susan⁶ Hawley**{ XE "Hawley:Susan (1820-)" \f "Name" \b } was born in 1820.

Susan married **Benjamin Mitchell Arnold**{ XE "Arnold:Benjamin Mitchell" \f "Name" \b \i }. They had six children: Elizabeth (1850-1850), George (1851-1891), Ephraim (1851-1919), Frederick (1856-1934), Stephen (1859-1867) and Sarah (1864-1924).

Ezra Benedict{ TC "Ezra Benedict" \I 3 \f C}

174. **Ezra Pearce⁵ Benedict**{ XE "Benedict:Ezra Pearce (1792-1852)" \f "Name" \b } (*Mary⁴ Sears, Susanna³ Townsend*) was born on Friday, 31st August 1792, in Danbury, Fairfield, Connecticut, USA{ XE "USA, Connecticut, Fairfield, Danbury:(41.3948° N, 73.454° W):Benedict, Ezra Pearce (1792-1852)" \f "Place" }. He was the son of Elijah Benedict{ XE "Benedict:Elijah (1765-1822)" \f "Name" \i } (14) and Mary Sears{ XE "Sears:Mary (1770-1866)" \f "Name" \i } (13).

He was buried at Westville Cemetery in Danbury{ XE "USA, Connecticut, Fairfield, Danbury:(41.3948° N, 73.454° W):Benedict, Ezra Pearce (1792-1852)" \f "Place" } in 1852. Ezra Pearce died in Danbury{ XE "USA, Connecticut, Fairfield, Danbury:(41.3948° N, 73.454° W):Benedict, Ezra Pearce (1792-1852)" \f "Place" } on 19th January 1852, at the age of 59.

SPM gr-st

More facts and events for Ezra Pearce Benedict:

Residence: 1850 Danbury{ XE "USA, Connecticut, Fairfield, Danbury:(41.3948° N, 73.454° W):Benedict, Ezra Pearce (1792-1852)" \f "Place" }

Marriages with Atha Sears and Rebecca Beebe (Page 215) are known.

Family of Ezra Benedict and Atha Sears{ TC "Ezra Benedict and Atha Sears" \I 4 \f C}

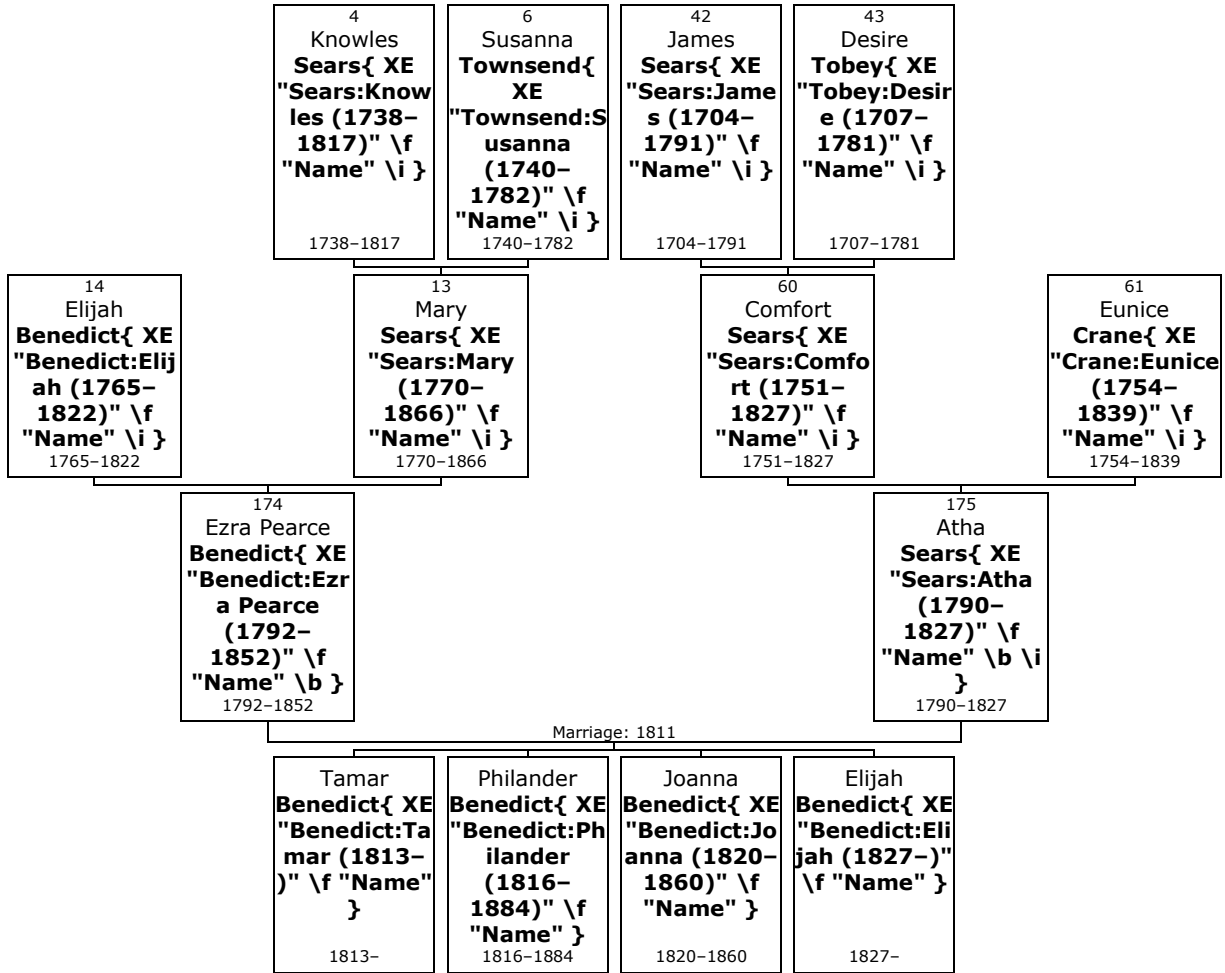

Here are the details about **Ezra Pearce Benedict's** first marriage, with Atha Sears. You can read more about Ezra Pearce on page 212.

- 175.** At the age of 18, Ezra Pearce Benedict married **Atha Sears** on Tuesday, 22nd January 1811, when she was 20 years old. They had four children: Tamar (1813-), Philander (1816-1884), Joanna (1820-1860) and Elijah (1827-).

Atha was born in Ridgefield, USA, Connecticut, Fairfield, Ridgefield, on Saturday, 18th December 1790. She was the daughter of Comfort Sears (60) and Eunice Crane (61).

Atha reached 36 years of age and died on 17th September 1827. She was buried in Bogg's District Cemetery.

<https://www.wikitree.com/wiki/Sears-4791>
S P May No 788

Children of Ezra Pearce Benedict and Atha Sears:

- f I. **Tamar⁶ Benedict** was born in perh, Ridgefield, USA, Connecticut, Fairfield, Ridgefield, perh: :Benedict, Tamar (1813-) on 22nd April 1813.
Tamar married **Ezra B Beebe**.
- m II. **Philander Benedict** was born in perh, USA, Connecticut, Fairfield, Ridgefield, perh: :Benedict, Philander (1816-

1884)" \f "Place" } on 2nd September 1816.^[318, 319, 320, 321, 322, 323-324] He died on 12th April 1884, at the age of 67.^[319] Philander was buried at Stony Hill Cemetery in Bethel{ XE "USA, Connecticut, Fairfield, Bethel:(41.3729° N, 73.4114° W):Benedict, Philander (1816-1884)" \f "Place" }.^[319]

More facts and events for Philander Benedict:

Residence: 1870 Danbury{ XE "USA, Connecticut, Fairfield, Danbury:(41.3948° N, 73.454° W):Benedict, Philander (1816-1884)" \f "Place" }.^[318]
 Age: 53; MaleCitizenOverTwentyone: Y;
 PersonalEstateValue: 500; Occupation: Carman

Philander married **Sarah Vail**{ XE "Vail:Sarah (1816-1869)" \f "Name" \b \i } on Wednesday, 2nd February 1842, in Connecticut{ XE "USA, Connecticut:(41.5735° N, 72.7383° W):Benedict, Philander (1816-1884)" \f "Place" }.^[318, 319] They had three children: Martha (1843-1903), Oliver (1847-1870) and Hiram (1854-1933).

Sarah was born in USA{ XE "USA: :Vail, Sarah (1816-1869)" \f "Place" } in 1816.^[318] She reached 53 years of age and died on 29th April 1869. Sarah was buried at Stony Hill Cemetery in Bethel{ XE "USA, Connecticut, Fairfield, Bethel:(41.3729° N, 73.4114° W):Vail, Sarah (1816-1869)" \f "Place" }.

- f III. **Joanna Benedict**{ XE "Benedict:Joanna (1820-1860)" \f "Name" \b } was born in perh{ XE "USA, Connecticut, Fairfield, Ridgefield, perh: :Benedict, Joanna (1820-1860)" \f "Place" } on 20th April 1820. She died on 20th July 1860, at the age of 40.
 Joanna married **Levi D Weed**{ XE "Weed:Levi D" \f "Name" \b \i }.
- m IV. **Elijah Benedict**{ XE "Benedict:Elijah (1827-)" \f "Name" \b } was born in perh{ XE "USA, Connecticut, Fairfield, Ridgefield, perh: :Benedict, Elijah (1827-)" \f "Place" } in 1827.

³¹⁸ Ancestry.com, 1870 United States Federal Census (Provo, UT, USA, Ancestry.com Operations, Inc., 2009), Ancestry.com, Year: 1870; Census Place: Danbury, Fairfield, Connecticut; Roll: M593_97; Page: 304B; Family History Library Film: 545596. Record for Filander Benedict. <http://search.ancestry.com/cgi-bin/sse.dll?db=7163&h=2141551&indiv=try>.

³¹⁹ FamilySearch.org, FamilySearch Family Tree, FamilySearch, "Family Tree," database, <i>FamilySearch</i> (<http://familysearch.org> : modified 12 July 2018, 05:47), entry for Philander Benedict(PID <https://familysearch.org/ark:/61903/4:1:LCRT-YPG>); contributed by various users. PersonID LCRT-YPG. Philander Benedict. <https://familysearch.org/ark:/61903/4:1:LCRT-YPG>.

³²⁰ FamilySearch.org, FamilySearch Family Tree, FamilySearch, "Connecticut Marriages, 1630-1997", database, <i>FamilySearch</i> (<https://familysearch.org/ark:/61903/1:1:F7PX-LJT> : 16 March 2018), Philander Benedict and Sarah Vail, 1842. Philander Benedict, "Connecticut Marriages, 1630-1997". <https://familysearch.org/ark:/61903/1:1:F7PX-LJT>.

³²¹ FamilySearch.org, FamilySearch Family Tree, FamilySearch, "Connecticut Marriages, 1630-1997", database, <i>FamilySearch</i> (<https://familysearch.org/ark:/61903/1:1:F7PX-LJ5> : 16 March 2018), Philander Benedict and Sarah Vail, 1842. Philander Benedict, "Connecticut Marriages, 1630-1997". <https://familysearch.org/ark:/61903/1:1:F7PX-LJ5>.

³²² FamilySearch.org, FamilySearch Family Tree, FamilySearch, "Connecticut Marriages, 1630-1997", database, <i>FamilySearch</i> (<https://familysearch.org/ark:/61903/1:1:F7PX-LJG> : 16 March 2018), Philander Benedict and Sarah Vail, 1842. Philander Benedict, "Connecticut Marriages, 1630-1997". <https://familysearch.org/ark:/61903/1:1:F7PX-LJG>.

³²³ FamilySearch.org, FamilySearch Family Tree, FamilySearch, "Connecticut Marriages, 1630-1997", database, <i>FamilySearch</i> (<https://familysearch.org/ark:/61903/1:1:F7PM-9YX> : 17 March 2018), Philander Benedict and Sarah Vail, 1842. Philander Benedict, "Connecticut Marriages, 1630-1997". <https://familysearch.org/ark:/61903/1:1:F7PM-9YX>.

³²⁴ FamilySearch.org, FamilySearch Family Tree, FamilySearch, "Connecticut Marriages, 1630-1997", database, <i>FamilySearch</i> (<https://familysearch.org/ark:/61903/1:1:F7GW-L5B> : 17 March 2018), Philander Benedict and Sarah Vail, 1842. Philander Benedict, "Connecticut Marriages, 1630-1997". <https://familysearch.org/ark:/61903/1:1:F7GW-L5B>.

Family of Ezra Benedict and Rebecca Beebe{ TC "Ezra Benedict and Rebecca Beebe" \I 4 \f C}

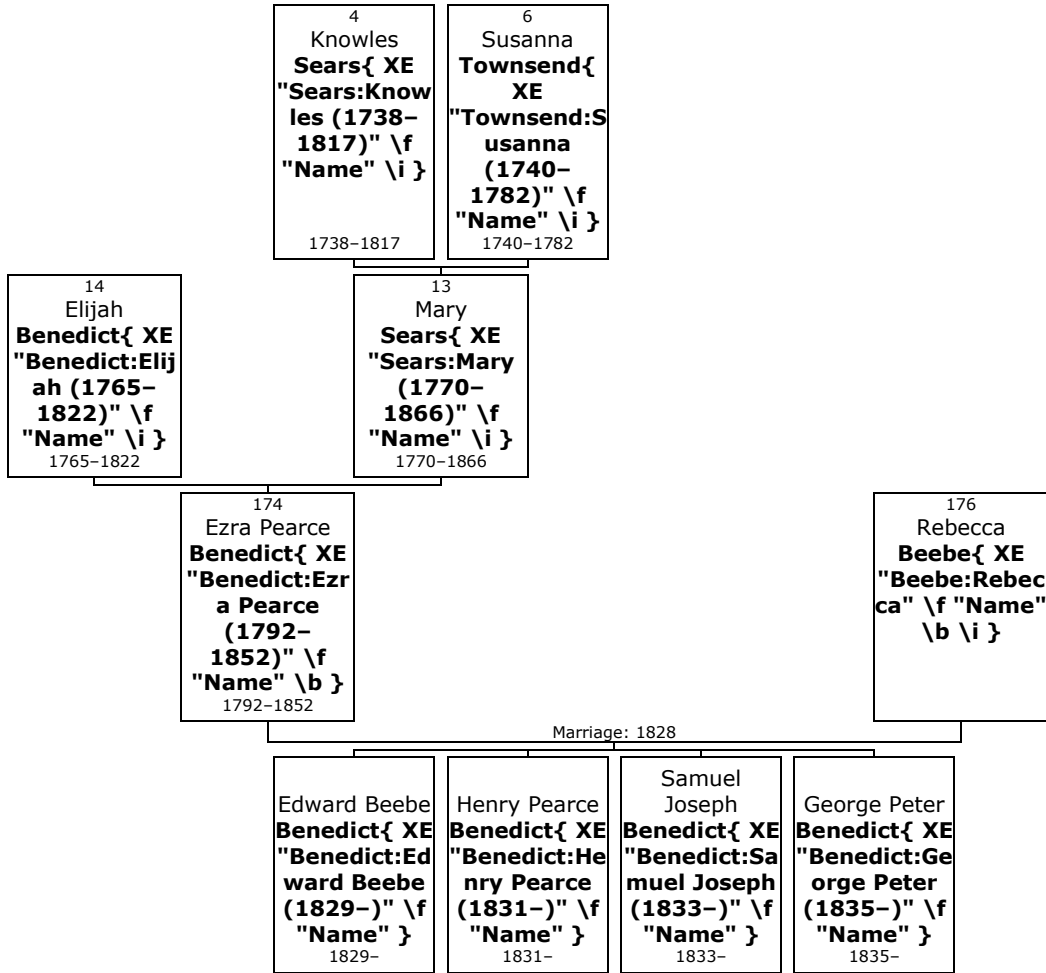

Here are the details about **Ezra Pearce Benedict's** second marriage, with Rebecca Beebe. You can read more about Ezra Pearce on page 212.

176. Ezra Pearce Benedict married **Rebecca Beebe** on Wednesday, 2nd April 1828. They had four sons: Edward (1829-), Henry (1831-), Samuel (1833-) and George (1835-).

Sons of Ezra Pearce Benedict and Rebecca Beebe:

- m I. **Edward Beebe⁶ Benedict** was born on 17th April 1829. Edward Beebe married **Justina Barnum**.
- m II. **Henry Pearce Benedict** was born on 2nd January 1831. Henry Pearce married **Mary Vail**.
- m III. **Samuel Joseph Benedict** was born on 3rd May 1833.^[325, 326]

More facts and events for Samuel Joseph Benedict:

Residence: 1860 Randolph{ XE "USA, New York, Cattaraugus,

³²⁵ Ancestry.com, 1860 United States Federal Census (Provo, UT, USA, Ancestry.com Operations, Inc., 2009), Ancestry.com, Year: 1860; Census Place: Randolph, Cattaraugus, New York; Roll: M653_726; Page: 692; Family History Library Film: 803726. Record for Samuel Benedict. <http://search.ancestry.com/cgi-bin/sse.dll?db=7667&h=45912708&indiv=try>.

³²⁶ Ancestry.com, 1870 United States Federal Census (Provo, UT, USA, Ancestry.com Operations, Inc., 2009), Ancestry.com, Year: 1870; Census Place: Randolph, Cattaraugus, New York; Roll: M593_909; Page: 490A; Family History Library Film: 552408. Record for Samuel J Benedict. <http://search.ancestry.com/cgi-bin/sse.dll?db=7163&h=27990958&indiv=try>.

Randolph:(42.162° N, 78.9753° W):Benedict, Samuel Joseph (1833-) \f "Place" }^[325]
Age: 27; Occupation: Furnace Man; PersonalEstateValue: 1500; RealEstateValue: 330

Residence: 1870 East Randolph{ XE "USA, New York, Cattaraugus, East Randolph:(42.1728° N, 78.9478° W):Benedict, Samuel Joseph (1833-) \f "Place" }^[326]
Age: 36; MaleCitizenOverTwentyone: Y;
PersonalEstateValue: 1000; RealEstateValue: 3000;
Occupation: Machinist

At the age of 28, Samuel Joseph married **Maria Harkness**{ XE "Harkness: Maria (1835-) \f "Name" \b \i } on Saturday, 5th October 1861, when she was 26 years old.^[326] They had one son: George (1862-).

Maria was born on Tuesday, 10th March 1835.^[326] She was the daughter of Oliver Harkness{ XE "Harkness: Oliver" \f "Name" \i } and Laura --Harkness{ XE "--Harkness: Laura" \f "Name" \i }.

m IV. **George Peter Benedict**{ XE "Benedict: George Peter (1835-) \f "Name" \b } was born on 5th December 1835.

George Peter married **Emily Melancthon**{ XE "Melancthon: Emily" \f "Name" \b \i }.

Family of Tamma Sears and John Lamerson{ TC "Tamma Sears and John Lamerson" \I 3 \f C}

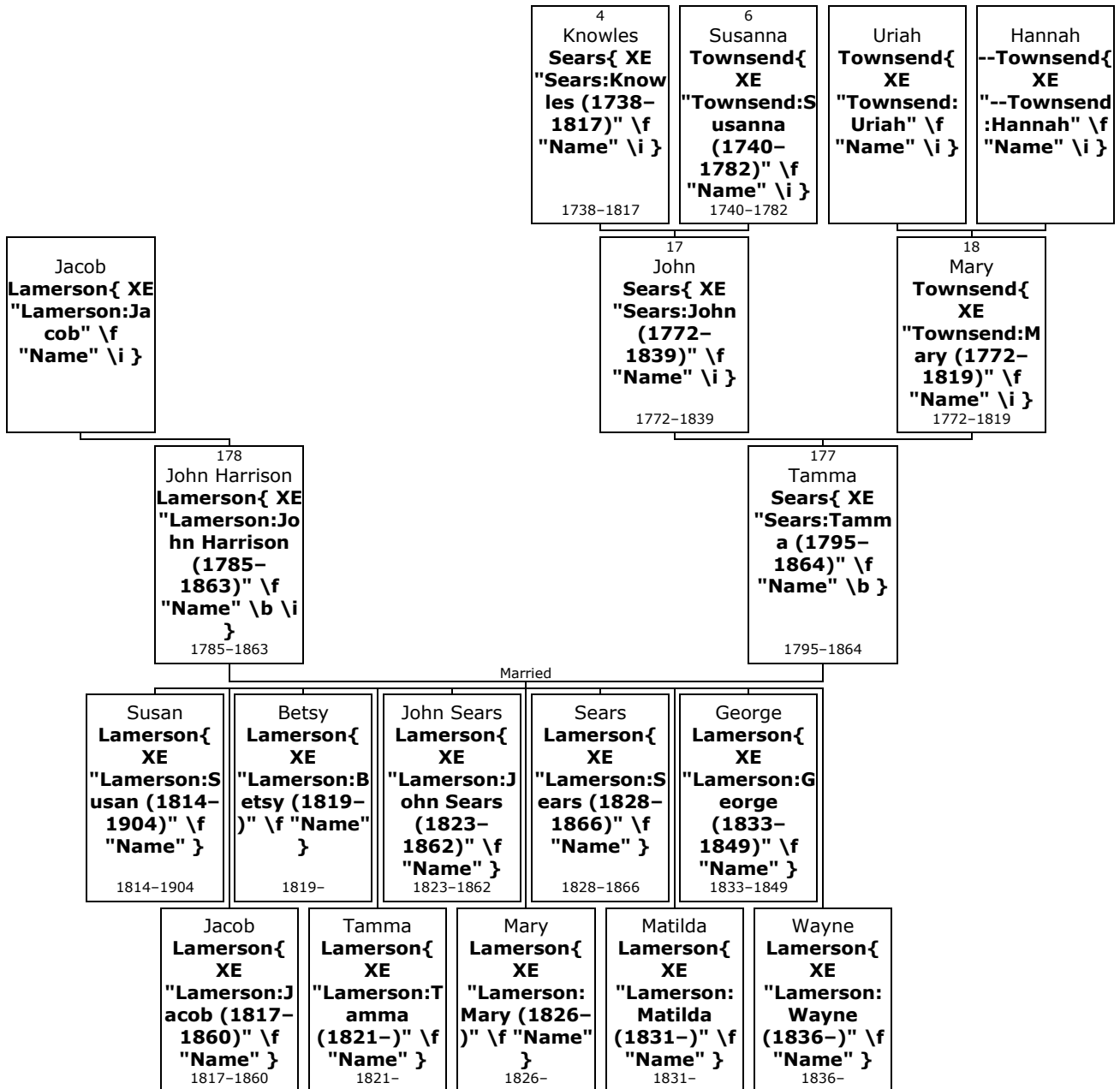

177. **Tamma⁵ Sears**{ XE "Sears:Tamma (1795-1864)" \f "Name" \b \i } (*John⁴, Susanna³ Townsend*) was born on Monday, 26th October 1795, in Camillus, Onondaga, New York, USA{ XE "USA, New York, Onondaga, Camillus:(43.0392° N, 76.3041° W):Sears, Tamma (1795-1864)" \f "Place" \i }.^[327] She was the daughter of John Sears{ XE "Sears:John (1772-1839)" \f "Name" \i } (17) and Mary Townsend{ XE "Townsend:Mary (1772-1819)" \f "Name" \i } (18).

Tamma died on 24th September 1864, at the age of 68.^[327] She was buried in Warners{ XE "USA, New York, Onondaga, Warners:(43.0853° N, 76.3294° W):Sears, Tamma (1795-1864)" \f "Place" \i }.^[327]

S P May No 1649

178. She married **John Harrison Lamerson**{ XE "Lamerson:John Harrison (1785-1863)" \f "Name" \b \i }.^[327] They had ten children: Susan (1814-1904), Jacob (1817-1860), Betsy (1819-), Tamma (1821-), John (1823-1862), Mary (1826-), Sears (1828-1866), Matilda (1831-), George (1833-1849) and Wayne (1836-).

³²⁷ Ancestry.com, U.S., Find A Grave Index, 1600s-Current (Provo, UT, USA, Ancestry.com Operations, Inc., 2012), Ancestry.com, Record for Susan Ladu. <http://search.ancestry.com/cgi-bin/sse.dll?db=60525&h=16544807&indiv=try>.

John Harrison was born in Pennsylvania{ XE "USA, Pennsylvania:(40.8583° N, 76.3834° W):Lamerson, John Harrison (1785–1863)" \f "Place" } on Wednesday, 16th November 1785.^[327] He was the son of Jacob Lamerson{ XE "Lamerson:Jacob" \f "Name" \i }.

John Harrison reached 77 years of age and died on 24th July 1863.^[327] He was buried in Warner's Rd Cemetery, Warners, Onondaga, New York{ XE "USA, New York, Onondaga, Warners, Warner's Rd Cemetery: :Lamerson, John Harrison (1785–1863)" \f "Place" }.^[327]

Children of Tamma Sears and John Harrison Lamerson:

- f I. **Susan⁶ Lamerson**{ XE "Lamerson:Susan (1814–1904)" \f "Name" \b } was born in perh, Camillus,{ XE "USA, New York, Onondaga, Camillus, perh: :Lamerson, Susan (1814–1904)" \f "Place" } on 18th December 1814.^[327, 328] She died on 14th March 1904, at the age of 89.^[327] Susan was buried in Warners{ XE "USA, New York, Onondaga, Warners:(43.0853° N, 76.3294° W):Lamerson, Susan (1814–1904)" \f "Place" }.^[327]
- At the age of 18, Susan married **Brinkerhoff La Du**{ XE "La Du:Brinkerhoff (1808–1883)" \f "Name" \b \i } on Thursday, 17th October 1833, in New York{ XE "USA, New York:(42.7531° N, 74.2224° W):Lamerson, Susan (1814–1904)" \f "Place" } when he was 25 years old.^[327, 328] They had ten children: Annis (1834–1875), Willet (1838–1921), (unknown given name) (1840–), John (1842–1913), Duane (1845–1915), Gilbert (1847–1914), Elva (1849–1900), J (1854–), Oscar (1856–) and Susan (1856–1874).
- Brinkerhoff was born in Dutchess, New York,{ XE "USA, New York, Dutchess:(41.7645° N, 73.7472° W):La Du, Brinkerhoff (1808–1883)" \f "Place" } on Friday, 15th July 1808.^[327, 328] He was the son of Tompkins La Du{ XE "La Du:Tompkins" \f "Name" \i } and Mercy Gilbert{ XE "Gilbert:Mercy" \f "Name" \i }.
- Brinkerhoff reached 75 years of age and died in Van Buren, Onondaga,{ XE "USA, New York, Onondaga, Van Buren:(43.1136° N, 76.3025° W):La Du, Brinkerhoff (1808–1883)" \f "Place" } on 1st November 1883.^[327] He was buried in Warners{ XE "USA, New York, Onondaga, Warners:(43.0853° N, 76.3294° W):La Du, Brinkerhoff (1808–1883)" \f "Place" }.^[327]
- !S.P. May shows La Duc. VTL Occup: farmer
- m II. **Jacob Lamerson**{ XE "Lamerson:Jacob (1817–1860)" \f "Name" \b } was born in perh{ XE "USA, New York, Onondaga, Camillus, perh: :Lamerson, Jacob (1817–1860)" \f "Place" } on 17th July 1817. He died on 6th June 1860, at the age of 42.
- Jacob married **Caroline Waterman**{ XE "Waterman:Caroline" \f "Name" \b \i }.
- f III. **Betsy Lamerson**{ XE "Lamerson:Betsy (1819–)" \f "Name" \b } was born in perh{ XE "USA, New York, Onondaga, Camillus, perh: :Lamerson, Betsy (1819–)" \f "Place" } on 7th June 1819.
- f IV. **Tamma Lamerson**{ XE "Lamerson:Tamma (1821–)" \f "Name" \b } was born in perh{ XE "USA, New York, Onondaga, Camillus, perh: :Lamerson, Tamma (1821–)" \f "Place" } on 12th July 1821.
- Tamma married **Isaac Peck**{ XE "Peck:Isaac" \f "Name" \b \i }.
- m V. **John Sears Lamerson**{ XE "Lamerson:John Sears (1823–1862)" \f "Name" \b } was born in perh{ XE "USA, New York, Onondaga, Camillus, perh: :Lamerson, John Sears (1823–1862)" \f "Place" } on 14th November 1823. He died on 8th February 1862, at the age of 38.
- John Sears married **Catherine Stevens**{ XE "Stevens:Catherine" \f "Name" \b \i }.
- f VI. **Mary Lamerson**{ XE "Lamerson:Mary (1826–)" \f "Name" \b } was born in perh{ XE "USA, New York, Onondaga, Camillus, perh: :Lamerson, Mary (1826–)" \f "Place" } on 3rd April 1826.
- Mary married **Zora Hayden**{ XE "Hayden:Zora" \f "Name" \b \i }.
- m VII. **Sears Lamerson**{ XE "Lamerson:Sears (1828–1866)" \f "Name" \b } was born in perh{ XE "USA, New York, Onondaga, Camillus, perh: :Lamerson, Sears (1828–1866)" \f "Place" } on 29th July 1828. He died on 28th April 1866, at the age of 37.

³²⁸ Ancestry.com, Michigan, Death Records, 1867-1950 (Provo, UT, USA, Ancestry.com Operations, Inc., 2015), Ancestry.com, Michigan Department of Community Health, Division for Vital Records and Health Statistics; Lansing, Michigan. Record for Susan Lamerson. <http://search.ancestry.com/cgi-bin/sse.dll?db=60872&h=753015898&indiv=try>.

Sears married **Sarah Allen**{ XE "Allen:Sarah" \f "Name" \b \i }.

f VIII. **Matilda Lamerson**{ XE "Lamerson:Matilda (1831-)" \f "Name" \b } was born in perh{ XE "USA, New York, Onondaga, Camillus, perh: :Lamerson, Matilda (1831-)" \f "Place" } on 17th May 1831.

Matilda married **William Peck**{ XE "Peck:William" \f "Name" \b \i }.

m IX. **George Lamerson**{ XE "Lamerson:George (1833-1849)" \f "Name" \b } was born in perh{ XE "USA, New York, Onondaga, Camillus, perh: :Lamerson, George (1833-1849)" \f "Place" } on 7th September 1833. He died on 13th May 1849, at the age of 15.

m X. **Wayne Lamerson**{ XE "Lamerson:Wayne (1836-)" \f "Name" \b } was born in perh{ XE "USA, New York, Onondaga, Camillus, perh: :Lamerson, Wayne (1836-)" \f "Place" } on 17th January 1836.

Wayne married **Henrietta Williams**{ XE "Williams:Henrietta" \f "Name" \b \i }.

Family of Hannah Sears and Cyrus Kingsley{ TC "Hannah Sears and Cyrus Kingsley" \I 3 \f C}

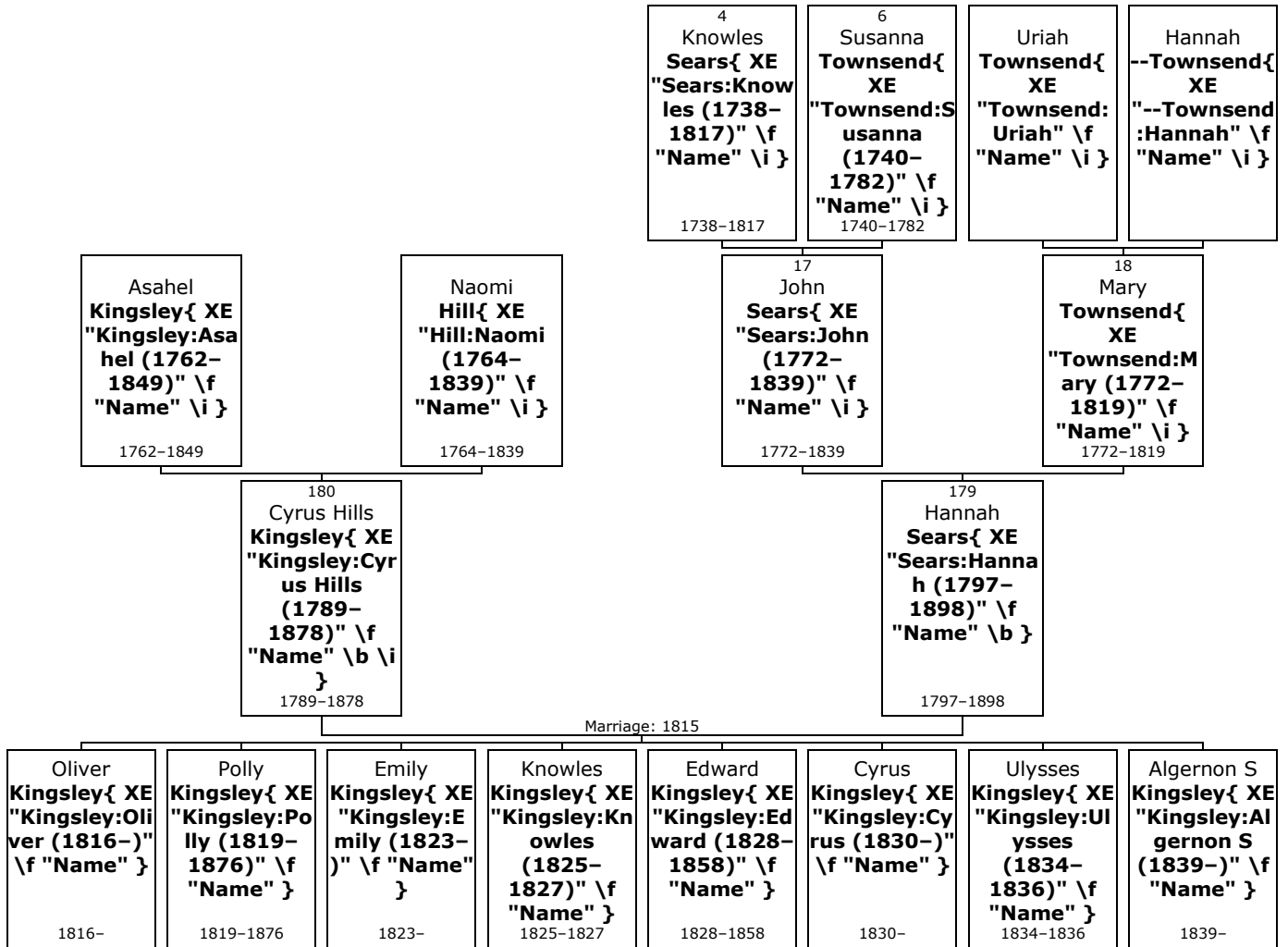

179. Hannah⁵ Sears{ XE "Sears:Hannah (1797-1898)" \f "Name" \b } (*John⁴, Susanna³ Townsend*) was born on Tuesday, 12th December 1797, in Camillus, Onondaga, New York, USA{ XE "USA, New York, Onondaga, Camillus:(43.0392° N, 76.3041° W):Sears, Hannah (1797-1898)" \f "Place" }.^[329] She was the daughter of John Sears{ XE "Sears:John (1772-1839)" \f "Name" \i } (17) and Mary Townsend{ XE "Townsend:Mary (1772-1819)" \f "Name" \i } (18).

³²⁹ Ancestry.com, New York, State Census, 1875 (Provo, UT, USA, Ancestry.com Operations, Inc., 2013), Ancestry.com. [Source citation includes one media item]

Hannah died in Van Buren{ XE "USA, New York, Onondaga, Van Buren:(43.1136° N, 76.3025° W):Sears, Hannah (1797–1898)" \f "Place" } on 16th March 1898, at the age of 100.

<https://www.wikitree.com/photo/jpg/Sears-4676>

S P May No1650

Olean Democrat, March 18,1898 (Olean NY) Syracuse, March 18-Mrs Cyrus H Kingsley of Lysander, Onondaga county, died at that place. She was 100 years old on Dec 12, 1897. Five of the nine children born to her are living, the eldest being 82 years old and the youngest 60 years.

Birth: Dec. 12, 1797 Albany County New York, USA Death: Mar. 16, 1898 Family links: Parents: John Sears (1772 - 1839) Mary Townsend Sears (1772 - 1819) Spouse: Cyrus Hill Kingsley (1789 - 1878) Burial: Riverview Cemetery Baldwinsville Onondaga County New York, USA Plot: 224 RV Maintained by: Donna Davenport Netters Originally Created by: Mojo Warren Record added: Jun 13, 2010 Find A Grave Memorial# 53661869

1860 United States Federal Census about Hannah Kingsley Age in 1860: 62 Birth Year: abt 1798 Birthplace: New York Home in 1860: Van Buren, Onondaga, New York Gender: Female Post Office: Camillus Value of real estate: View image Household Members: Name Age Cyrus W Kingsley 70 Hannah Kingsley 62 A Sidney 23 Eliza Sidney 15 Spencer Sears 14 Thomas Grimes 18

1880 United States Federal Census about Hannah Kingsley Age: 82 Birth Year: abt 1798 Birthplace: New York Home in 1880: Van Buren, Onondaga, New York Race: White Gender: Female Relation to Head of House: Mother Marital Status: Widowed Father's Birthplace: Connecticut Mother's Birthplace: Connecticut Household Members: Name Age Sidney Kingsley 43 Hannah Kingsley 82

More facts and events for Hannah Sears:

Residence: 1st June 1875 Van Buren{ XE "USA, New York, Onondaga, Van Buren:(43.1136° N, 76.3025° W):Sears, Hannah (1797–1898)" \f "Place" }^[329]
Relation to Head: Wife

- 180.** At the age of 17, Hannah married **Cyrus Hills Kingsley**{ XE "Kingsley:Cyrus Hills (1789–1878)" \f "Name" \b \i } on Monday, 6th November 1815, in Camillus{ XE "USA, New York, Onondaga, Camillus:(43.0392° N, 76.3041° W):Sears, Hannah (1797–1898)" \f "Place" } when he was 26 years old.^[329] They had eight children: Oliver (1816–), Polly (1819–1876), Emily (1823–), Knowles (1825–1827), Edward (1828–1858), Cyrus (1830–), Ulysses (1834–1836) and Algernon (1839–).

Cyrus Hills was born in Lebanon, New London, Connecticut,{ XE "USA, Connecticut, New London, Lebanon:(41.6361° N, 72.2131° W):Kingsley, Cyrus Hills (1789–1878)" \f "Place" } on Friday, 21st August 1789.^[329] He was the son of Asahel Kingsley{ XE "Kingsley:Asahel (1762–1849)" \f "Name" \i } and Naomi Hill{ XE "Hill:Naomi (1764–1839)" \f "Name" \i }.

Cyrus Hills reached 89 years of age and died in Van Buren{ XE "USA, New York, Onondaga, Van Buren:(43.1136° N, 76.3025° W):Kingsley, Cyrus Hills (1789–1878)" \f "Place" } on 16th December 1878.

Obit copied from a book by Mary Blake Manning Trotter; The late Cyrus H Kingsley, of Van Buren, was a remarkable man in many respects, and was qualified by his experience and knowledge to fill almost any position in life relating to general matters. He was one of the most industrious readers of books and newspapers in our county. His intelligence was such that he could interest one for hours with his varied knowledge of men and other important matters. His knowledge extended over a period covering three quarters of a century. Of agriculture and its application, he had intimate knowledge, at least up to within ten or fifteen years of his death. Cyrus H Kingsley was born in Lebanon, Connecticut, August 31, 1789; he died December 16, 1878. He went to Kinderhook in 1811, taught school there one year, and subsequently located temporarily in Granby, Oswego county, in 1812. Not satisfied with Granby, he went to Van Buren, and located on the farm now occupied by ex-Supervisor A W Bingham. He went out as a soldier in the war of 1812. Had he lived until August 31, 1879, he would have attained the age of ninety years. He always enjoyed good health, and when young, resolute and strong, and full of hope, he purchased, in the spring of 1815, the then wilderness farm where his surviving wife now resides, and where he himself died. On the 16th of November, 1815, he married Miss Hannah Sears, with whom he lived sixty three years, and by whom he had nine children, six sons and three daughters, five of whom are now living. Two of his sons live west; Oliver in Waterloo, Indiana; Cyrus, in Hillsdale, Michigan; and Algenon on the old farm in Van Buren. His two daughters are noth residents of this county. Mrs Lewis Talmadge resides in Van Buren; Mrs Morehouse lives in Liverpool. One of the daughters who is now dead, married the Hon Charles Blake, of Ottumwa, Iowa. Cyrus H Kingsley's father was a Revolutionary soldier. Cyrus H Kingsley was a member of the Constitutional convention of 1846. He was a member of the Board of Supervisors for several years in this county. He was a man of most excellent common sense and good judgement. His views on the

great questions of the day were always on the right side. He was a Democrat for many years, and he well knew the true meaning of the word Democracy, and we believe understood it differently from many of the modern-day Democrats. For many years of the latter portion of his life, he was an ardent Republican, devoted to the success of the great Republican party in its relations appertaining to the salvation of the country, during the great struggle, and to its proud record since that memorable struggle. Mr Kingsley leaves an enviable record. His honesty was proverbial. His devotedness to sound principles was characteristic of the man. He had lived nearly a century to witness the mighty growth of this great country, now numbering forty-five millions of people. His every-day conversation with his fellow-townsmen indicated in most terse language how well he knew of the strides of science and agriculture, and a thousand and one other important things constantly looming up to make us the foremost people on the globe. It would be well for this country, were all its citizens as exemplary and intelligent as was Cyrus H Kingsley, of whom we can speak only in the kindest words for his fidelity to principle, honesty of purpose, and nobleness of heart. Birth: Aug. 31, 1789 New London County Connecticut, USA Death: Dec. 16, 1878 New York, USA Family links: Parents: Asahel Kingsley (1762 - 1849) Naomi Hill Kingsley (1764 - 1839) Spouse: Hannah Sears Kingsley (1797 - 1898)* *Calculated relationship Burial: Riverview Cemetery Baldwinsville Onondaga County New York, USA Plot: 224 RV Maintained by: Donna Davenport Netters Originally Created by: Mojo Warren Record added: Jun 13, 2010 Find A Grave Memorial# 53661859

More facts and events for Cyrus Hills Kingsley:

Residence: 1st June 1875 Van Buren{ XE "USA, New York, Onondaga, Van Buren:(43.1136° N, 76.3025° W):Kingsley, Cyrus Hills (1789-1878)" \f "Place" }^[329]
Relation to Head: Head

Children of Hannah Sears and Cyrus Hills Kingsley:

m I. **Oliver⁶ Kingsley**{ XE "Kingsley:Oliver (1816-)" \f "Name" \b } was born in perh, Camillus,{ XE "USA, New York, Onondaga, Camillus, perh: :Kingsley, Oliver (1816-)" \f "Place" } on 16th August 1816.

f II. **Polly Kingsley**{ XE "Kingsley:Polly (1819-1876)" \f "Name" \b } was born in Van Buren{ XE "USA, New York, Onondaga, Van Buren:(43.1136° N, 76.3025° W):Kingsley, Polly (1819-1876)" \f "Place" } on 1st January 1819. She died in Ottumwa, Wapello, Iowa,{ XE "USA, Iowa, Wapello, Ottumwa:(41.02° N, 92.4113° W):Kingsley, Polly (1819-1876)" \f "Place" } on 12th June 1876, at the age of 57. Polly was buried in Ottumwa Cemetery, Ottumwa{ XE "USA, Iowa, Wapello, Ottumwa, Ottumwa Cemetery: :Kingsley, Polly (1819-1876)" \f "Place" }.



Polly

At the age of 37, Polly married **Charles F Blake**{ XE "Blake:Charles F (1823-1897)" \f "Name" \b \i } on Monday, 9th June 1856, when he was 32 years old. They had two children: Juliet (1857-1930) and Lyons (1862-).

Charles F was born on Sunday, 12th October 1823. Minden, Prussia. He was the son of Carl F Blake{ XE "Blake:Carl F" \f "Name" \i } and Mary Mideman{ XE "Mideman:Mary" \f "Name" \i }.

Charles F reached 73 years of age and died in Ottumwa{ XE "USA, Iowa, Wapello, Ottumwa:(41.02° N, 92.4113° W):Blake, Charles F (1823-1897)" \f "Place" } on 23rd March 1897. He was buried in Ottumwa Cemetery, Ottumwa{ XE "USA, Iowa, Wapello, Ottumwa, Ottumwa Cemetery: :Blake, Charles F (1823-1897)" \f "Place" }.

from Stephanie Trotter- Mar 23 1897, Charles F Blake, an old and honored citizen of Ottumwa, died at his late residence on East Second street, Tuesday, March 23, from a general breakdown of his system, caused by anxiety and overwork; the immediate cause seemed to be from the formation of a blood clot at the base of the brain which brought on paralysis of the heart. He had returned about twenty days ago from South Dakota, where he was engaged in mining and prospecting and on the way home was attacked with symptoms of the disease, and when he arrived took to his bed and gradually declined until his death. He died peacefully, without pain, and up to a short time before actual dissolution took place he remained in full possession of his mental faculties.

Charles F Blake was a native of Germany, and was born near Minden, Prussia, October 12, 1823, being, therefore nearly 74 years old at the time of his death. His parents, Carl F., and Mary (Mideman) Blake, resided on a farm in their native country until 1836, when,

accompanied by their seven children, they emigrated to the United States, and first made settlement in Hamilton county, Ohio. Six months later the family removed to Clermont county, same state, and located near Milford, and in 1840 made another move, this time taking up their residence on a farm near Indianapolis, Indiana.

In 1845 they came to Iowa and located in Ottumwa, being among the earliest pioneers of this section, they continued to reside there an unbroken family until 1853, when the demise of the father occurred, his age being 58 years. The mother died October 25, 1870.

Mr. Blake was married in 1856 to Miss Polly Kingsley, on Onondaga county, New York, who died in 1876, leaving two children, Juliette K, wife of Hon. Calvin Manning; and Cyrus K., now of Omaha. In 1877 Mr Blake married Mrs. Jennie E. Stevens, by whom he had one son, Frederick. She was the mother of Mrs F. M. Hunter, of this city.

In the spring of 1850 Mr Blake went to California, where he engaged in mining, returning in 1852 with a small amount of money which he judiciously invested in Ottumwa real estate, and was employed in the store of Jame Hawley, Sr, and in 1863 he became bookkeeper in the house of James L Taylor, and in 1865 was associated with Mr Taylor in the firm of Taylor, Blake & Co., in the wholesale and retail drug trade. In 1873 he became president of the Iowa National bank and in 1881 organized the firm of xxxx wholesale druggists. During these periods, he held various offices of trust in the city, and for several years represented his ward in the city council, where his good business qualities were of great value in conducting public affairs. In the conduct of his private affairs he met with great success; his real estate up to a certain date, yielded handsome profits, and Mr Blake was esteemed a rich man. In 1886 he became interested with J. O. Briscoe in mining property in Montana, and from that time on his financial affairs did not prosper; he had also invested large amounts in farm property in this county which did not yield an adequate return, and advantageous sales could not be effected. These conditions finally compelled him to make an assignment, and this was a hard blow on the sturdy man of affairs who had always been so prosperous, and his friends could see that he suffered intensely from anxiety. It was a pathetic sight, and yet it was courageous, in him, to see this aged man of over three score years and ten, go to the mountains last December, to make a last effort to redeem his fortune in mines where he had lost so much. It is said, however, that his affairs were brightening up materially and the chances are favorable that his estate will yet yield sufficient to redeem the losses, if the times improve within the next one or two years.

The writer of these lines has known Mr Blake for over thirty years and it is pleasant to record of him that he never oppressed the many poor men who became indebted to him for their little homes; on the contrary, he bore with them, carried their indebtedness; was lenient to a fault, and these men will never cease to honor his memory. Mr Blake was always at the front in every public enterprise; it is certain that he gave more money to these objects than any other man in the city. "Charley" Blake, as he was always called, could be depended upon in every emergency, to contribute his time and money to objects of public good. He was charitable, generous, and, so long as he was able financially, he never refused to contribute to public enterprises, and his word in all respects was equivalent to his bond. There will be many outside the family circle in Ottumwa to mourn over the death of Charles F Blake; he has, in his time, been of great service to his fellow men, and his memory will be cherished by those who have been the recipients of his many gracious acts of kindness.

- f III. **Emily Kingsley**{ XE "Kingsley:Emily (1823-)" \f "Name" \b } was born in perh, Camillus,{ XE "USA, New York, Onondaga, Camillus, perh: :Kingsley, Emily (1823-)" \f "Place" } on 17th March 1823.
- m IV. **Knowles Kingsley**{ XE "Kingsley:Knowles (1825-1827)" \f "Name" \b } was born in perh{ XE "USA, New York, Onondaga, Camillus, perh: :Kingsley, Knowles (1825-1827)" \f "Place" } on 18th October 1825. He died on 15th February 1827, at the age of 1.
- m V. **Edward Kingsley**{ XE "Kingsley:Edward (1828-1858)" \f "Name" \b } was born in perh{ XE "USA, New York, Onondaga, Camillus, perh: :Kingsley, Edward (1828-1858)" \f "Place" } on 25th April 1828. He died on 14th October 1858, at the age of 30.
- m VI. **Cyrus Kingsley**{ XE "Kingsley:Cyrus (1830-)" \f "Name" \b } was born in perh{ XE "USA, New York, Onondaga, Camillus, perh: :Kingsley, Cyrus (1830-)" \f "Place" } on 29th July 1830.

- m VII. **Ulysses Kingsley**{ XE "Kingsley:Ulysses (1834-1836)" \f "Name" \b } was born in perh{ XE "USA, New York, Onondaga, Camillus, perh: :Kingsley, Ulysses (1834-1836)" \f "Place" } on 23rd January 1834. He died on 11th September 1836, at the age of 2.
- m VIII. **Algernon S Kingsley**{ XE "Kingsley:Algernon S (1839-)" \f "Name" \b } was born in perh{ XE "USA, New York, Onondaga, Camillus, perh: :Kingsley, Algernon S (1839-)" \f "Place" } on 2nd January 1839.^[329, 330-331]

More facts and events for Algernon S Kingsley:

Residence: 1850 Van Buren{ XE "USA, New York, Onondaga, Van Buren:(43.1136° N, 76.3025° W):Kingsley, Algernon S (1839-)" \f "Place" }^[330]

Age: 13

Residence: 1st June 1875 Van Buren{ XE "USA, New York, Onondaga, Van Buren:(43.1136° N, 76.3025° W):Kingsley, Algernon S (1839-)" \f "Place" }^[329]

Relation to Head: Son

Algernon S Kingsley married **Sarah O. Green**{ XE "Green:Sarah O. (1839-)" \f "Name" \b \i } on Thursday, 18th November 1869, in Ashtabula, Ohio{ XE "USA, Ohio, Ashtabula:(41.8901° N, 80.7559° W):Kingsley, Algernon S (1839-)" \f "Place" }.^[331] They had two sons: Darwin and Celey.

Sarah O. was born in Ohio{ XE "USA, Ohio:(40.2083° N, 81.325° W):Green, Sarah O. (1839-)" \f "Place" } in 1839.

³³⁰ Ancestry.com, 1850 United States Federal Census (Provo, UT, USA, Ancestry.com Operations, Inc., 2009), Ancestry.com, Year: 1850; Census Place: Van Buren, Onondaga, New York; Roll: M432_570; Page: 412A; Image: 300. Record for Algernon S Kingsley. <http://search.ancestry.com/cgi-bin/sse.dll?db=8054&h=7861365&indiv=try>.

³³¹ Ancestry.com, Ohio, County Marriages, 1774-1993 (Lehi, UT, USA, Ancestry.com Operations, Inc., 2016), Ancestry.com, Record for Sarah O. Green. <http://search.ancestry.com/cgi-bin/sse.dll?db=61378&h=904176980&indiv=try>.

Family of John Sears and Phebe Cook{ TC "John Sears and Phebe Cook" \I 3 \f C}

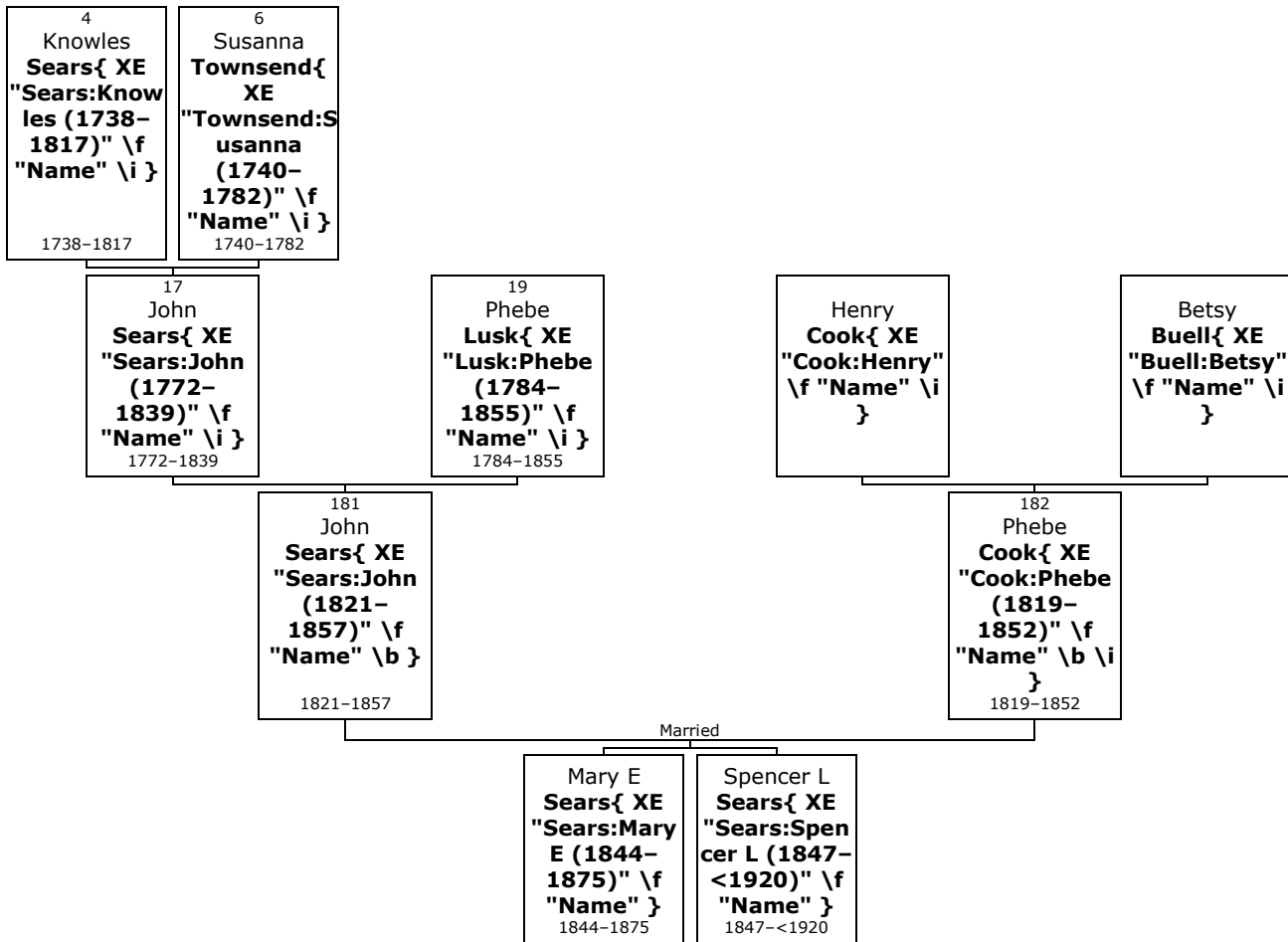

- 181.** **John⁵ Sears**{ XE "Sears:John (1821-1857)" \f "Name" \b } (*John⁴, Susanna³ Townsend*) was born on Monday, 15th January 1821, in Camillus, Onondaga, New York, USA{ XE "USA, New York, Onondaga, Camillus:(43.0392° N, 76.3041° W):Sears, John (1821-1857)" \f "Place" }.^[332] He was the son of John Sears{ XE "Sears:John (1772-1839)" \f "Name" \i } (17) and Phebe Lusk{ XE "Lusk:Phebe (1784-1855)" \f "Name" \i } (19).

John died on 29th January 1857, at the age of 36.

S P May No 1654 1850 United States Federal Census

<http://www.ancestry.com/search/db.aspx?dbid=8054&enc=1> about John Sears Name: John Sears Age: 28 Estimated birth year: abt 1822 Birth Place: New York Gender: Male Home in 1850 (City,County,State): Wolcott, Wayne, New York Family Number: 181 Household Members: Name Age John Sears

<http://search.ancestry.com/cgi-bin/sse.dll?db=1850usfedcenancestry&indiv=try&h=8812122> 28 Phebe Sears

<http://search.ancestry.com/cgi-bin/sse.dll?db=1850usfedcenancestry&indiv=try&h=8812123> 31 Mary E Sears

<http://search.ancestry.com/cgi-bin/sse.dll?db=1850usfedcenancestry&indiv=try&h=8812124> 6 Spencer L Sears

<http://search.ancestry.com/cgi-bin/sse.dll?db=1850usfedcenancestry&indiv=try&h=8812125> 3 Phebe Sears

<http://search.ancestry.com/cgi-bin/sse.dll?db=1850usfedcenancestry&indiv=try&h=8812126> 66

<https://www.wikitree.com/wiki/Sears-5727>

³³² Ancestry.com, 1850 United States Federal Census (Provo, UT, USA, Ancestry.com Operations, Inc., 2009), Ancestry.com, Year: 1850; Census Place: Wolcott, Wayne, New York; Roll: M432_613; Page: 524B; Image: 458. [Source citation includes one media item]

More facts and events for John Sears:

Residence: 1850 Wolcott{ XE "USA, New York, Wayne, Wolcott:(43.2206° N, 76.815° W):Sears, John (1821–1857)" \f "Place" }^[332]

- 182.** He married **Phebe Cook**{ XE "Cook:Phebe (1819–1852)" \f "Name" \b \i }.^[332, 333] They had two children: Mary (1844–1875) and Spencer (1847–<1920).

Phebe was born in perh, Red Creek,{ XE "USA, New York, Wayne, Red Creek, perh: :Cook, Phebe (1819–1852)" \f "Place" } on Wednesday, 2nd June 1819.^[332, 333] She was the daughter of Henry Cook{ XE "Cook:Henry" \f "Name" \i } and Betsy Buell{ XE "Buell:Betsy" \f "Name" \i }.

Phebe reached 32 years of age and died on 1st June 1852.^[333] She was buried in Warners, Onondaga County{ XE "USA, New York, Onondaga County, Warners:(43.0853° N, 76.3294° W):Cook, Phebe (1819–1852)" \f "Place" }.^[333]

!S.P. May handnotes

More facts and events for Phebe Cook:

Residence: 1850 Wolcott, Wayne{ XE "USA, New York, Wayne, Wolcott:(43.2206° N, 76.815° W):Cook, Phebe (1819–1852)" \f "Place" }^[332]

Children of John Sears and Phebe Cook:

- f I. **Mary E⁶ Sears**{ XE "Sears:Mary E (1844–1875)" \f "Name" \b } was born in Red Creek{ XE "USA, New York, Wayne, Red Creek:(43.2473° N, 76.7236° W):Sears, Mary E (1844–1875)" \f "Place" } on 29th August 1844.^[332] She died on 7th December 1875, at the age of 31.

More facts and events for Mary E Sears:

Residence: 1850 Wolcott{ XE "USA, New York, Wayne, Wolcott:(43.2206° N, 76.815° W):Sears, Mary E (1844–1875)" \f "Place" }^[332]

Mary E married **Mills St. Douglass**{ XE "St. Douglass:Mills (1834–)" \f "Name" \b \i }. They had three children: Luella (1863–1883), Harvey (1864–1876) and Frank (1871–).

Mills was born in Sterling, Cayuga,{ XE "USA, New York, Cayuga, Sterling:(43.3258° N, 76.6453° W):St. Douglass, Mills (1834–)" \f "Place" } on Wednesday, 12th November 1834. He was the son of Harvey Douglass{ XE "Douglass:Harvey (1808–)" \f "Name" \i } and Susan Lester{ XE "Lester:Susan (1812–)" \f "Name" \i }.

- m II. **Spencer L Sears**{ XE "Sears:Spencer L (1847–<1920)" \f "Name" \b } was born in Red Creek{ XE "USA, New York, Wayne, Red Creek:(43.2473° N, 76.7236° W):Sears, Spencer L (1847–<1920)" \f "Place" } on 13th April 1847.^[334, 335–336] He died before 1920.

More facts and events for Spencer L Sears:

Residence: 1900 Wolcott{ XE "USA, New York, Wayne, Wolcott:(43.2206° N, 76.815° W):Sears, Spencer L (1847–<1920)" \f "Place" }^[335]

Marital Status: Married; Relation to Head: Head

³³³ Ancestry.com, U.S., Find A Grave Index, 1600s-Current (Provo, UT, USA, Ancestry.com Operations, Inc., 2012), Ancestry.com.

³³⁴ Ancestry.com, New York, State Census, 1905 (Provo, UT, USA, Ancestry.com Operations, Inc., 2014), Ancestry.com, New York State Archives; Albany, New York; State Population Census Schedules, 1905; Election District: A.D. 01 E.D. 01; City: Wolcott; County: Wayne; Page: 27.

³³⁵ Ancestry.com, 1900 United States Federal Census (Provo, UT, USA, Ancestry.com Operations Inc, 2004), Ancestry.com, Year: 1900; Census Place: Wolcott, Wayne, New York; Roll: 1174; Page: 17B; Enumeration District: 0130; FHL microfilm: 1241174.

³³⁶ Ancestry.com, 1910 United States Federal Census (Provo, UT, USA, Ancestry.com Operations Inc, 2006), Ancestry.com, Year: 1910; Census Place: Wolcott, Wayne, New York; Roll: T624_1094; Page: 13A; Enumeration District: 0169; FHL microfilm: 1375107.

Residence: 1905 Wolcott{ XE "USA, New York, Wayne, Wolcott:(43.2206° N, 76.815° W):Sears, Spencer L (1847-<1920)" \f "Place" }^[334]

Relationship to Head: Head

Residence: 1910 Wolcott{ XE "USA, New York, Wayne, Wolcott:(43.2206° N, 76.815° W):Sears, Spencer L (1847-<1920)" \f "Place" }^[336]

Marital Status: Married; Relation to Head of House: Head

Spencer L Sears married **Caroline H Carrie Coleman**{ XE "Coleman:Caroline H \"Carrie\" (1847-)" \f "Name" \b \i } in 1871.^[334, 337, 338-339] They had two children: (unknown given name) (1869-1869) and Edna (1874-).

Carrie was born in Conquest, Cayuga,{ XE "USA, New York, Cayuga, Conquest:(43.1211° N, 76.6484° W):Coleman, Caroline H \"Carrie\" (1847-)" \f "Place" } on Saturday, 7th August 1847.^[334-339] She was the daughter of Lauren Coleman{ XE "Coleman:Lauren (1821-)" \f "Name" \i } and Ann M Cosgrove{ XE "Cosgrove:Ann M (1819-)" \f "Name" \i }.

³³⁷ Ancestry.com, 1920 United States Federal Census (Provo, UT, USA, Ancestry.com Operations Inc, 2010), Ancestry.com, Year: 1920; Census Place: Wolcott, Wayne, New York; Roll: T625_1274; Page: 6A; Enumeration District: 171.
[Source citation includes one media item]

³³⁸ Ancestry.com, New York, State Census, 1925 (Provo, UT, USA, Ancestry.com Operations, Inc., 2012), Ancestry.com, New York State Archives; Albany, New York; State Population Census Schedules, 1925; Election District: 04; Assembly District: 01; City: Wolcott; County: Wayne; Page: 5.
[Source citation includes one media item]

³³⁹ Ancestry.com, 1930 United States Federal Census (Provo, UT, USA, Ancestry.com Operations Inc, 2002), Ancestry.com, Year: 1930; Census Place: Wolcott, Wayne, New York; Roll: 1658; Page: 6A; Enumeration District: 0047; Image: 907.0; FHL microfilm: 2341392.
[Source citation includes one media item]

Family of James Sears and Matilda Cartwright{ TC "James Sears and Matilda Cartwright" \I 3 \f C}

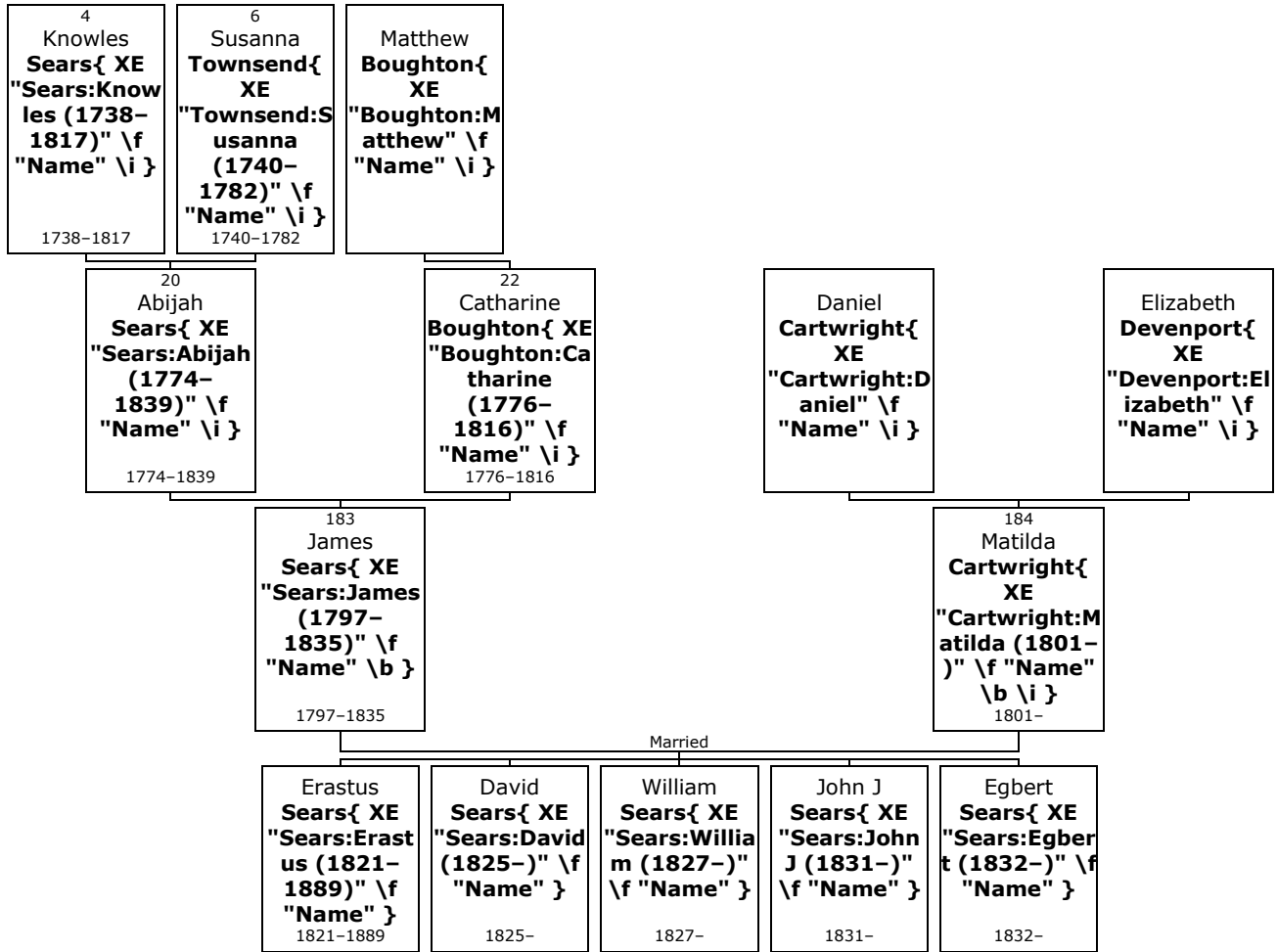

183. **James⁵ Sears**{ XE "Sears:James (1797-1835)" \f "Name" \b } (*Abijah⁴, Susanna³ Townsend*) was born on Friday, 12th May 1797, in Eaton, Madison, New York, USA{ XE "USA, New York, Madison, Eaton:(42.8497° N, 75.6122° W):Sears, James (1797-1835)" \f "Place" }.^[340] He was the son of Abijah Sears{ XE "Sears:Abijah (1774-1839)" \f "Name" \i } (20) and Catharine Boughton{ XE "Boughton:Catharine (1776-1816)" \f "Name" \i } (22).

James died in Danby{ XE "USA, New York, Tompkins, Danby:(42.3522° N, 76.4811° W):Sears, James (1797-1835)" \f "Place" } on 29th June 1835, at the age of 38.

!S.P. May No 1656 p.420 Was a farmer in Danby, NY

<https://www.wikitree.com/wiki/Sears-5717>

More facts and events for James Sears:

Residence: 1830 Danby{ XE "USA, New York, Tompkins, Danby:(42.3522° N, 76.4811° W):Sears, James (1797-1835)" \f "Place" }.^[340]

184. He married **Matilda Cartwright**{ XE "Cartwright:Matilda (1801-)" \f "Name" \b \i }.^[341] They had five sons: Erastus (1821-1889), David (1825-), William (1827-), John (1831-) and Egbert (1832-).

³⁴⁰ Ancestry.com, 1830 United States Federal Census (Provo, UT, USA, Ancestry.com Operations, Inc., 2010), Ancestry.com, 1830; Census Place: Danby, Tompkins, New York; Series: M19; Roll: 109; Page: 430; Family History Library Film: 0017169. [Source citation includes one media item]

³⁴¹ Ancestry.com, New Jersey, Births and Christenings Index, 1660-1931 (Provo, UT, USA, Ancestry.com Operations, Inc., 2011), Ancestry.com.

Matilda was born in perh, Danby,{ XE "USA, New York, Tompkins, Danby, perh: :Cartwright, Matilda (1801-)" \f "Place" } in 1801.^[341] She was the daughter of Daniel Cartwright{ XE "Cartwright:Daniel" \f "Name" \i } and Elizabeth Devenport{ XE "Devenport:Elizabeth" \f "Name" \i }.

She was baptised in Clove Valley Dutch Reformed Church, Wantage, Sussex, New Jersey,{ XE "USA, New Jersey, Sussex, Wantage, Clove Valley Dutch Reformed Church: :Cartwright, Matilda (1801-)" \f "Place" } on 23rd December 1804.^[341]

Sons of James Sears and Matilda Cartwright:

- m I. **Erastus⁶ Sears**{ XE "Sears:Erastus (1821-1889)" \f "Name" \b } was born in Danby, Tompkins, New York,{ XE "USA, New York, Tompkins, Danby:(42.3522° N, 76.4811° W):Sears, Erastus (1821-1889)" \f "Place" } on 10th December 1821.^[342, 343] He died in West Danby, Danby,{ XE "USA, New York, Tompkins, Danby, West Danby: :Sears, Erastus (1821-1889)" \f "Place" } on 10th April 1889, at the age of 67.^[342] Erastus was buried in West Danby{ XE "USA, New York, Tompkins, Danby, West Danby: :Sears, Erastus (1821-1889)" \f "Place" }.^[342]



Erastus

More facts and events for Erastus Sears:

Residence: 1865 Danby{ XE "USA, New York, Tompkins, Danby:(42.3522° N, 76.4811° W):Sears, Erastus (1821-1889)" \f "Place" }.^[343]

Relation to Head of House: Head

Erastus married **Sally A --Sears**{ XE "--Sears:Sally A (1821-1872)" \f "Name" \b \i }.^[342, 343] They had two children: Adelia (1851-1892) and John (1855-1881).

Sally A was born in New Jersey{ XE "USA, New Jersey:(40.1388° N, 74.6769° W):--Sears, Sally A (1821-1872)" \f "Place" } on Monday, 25th June 1821.^[342, 343] She reached 50 years of age and died in New York{ XE "USA, New York:(42.7531° N, 74.2224° W):--Sears, Sally A (1821-1872)" \f "Place" } on 22nd June 1872.^[342]

Sally A was buried in West Danby, Danby, Tompkins, New York{ XE "USA, New York, Tompkins, Danby, West Danby: :--Sears, Sally A (1821-1872)" \f "Place" }.^[342]

Sarah A in the census

- m II. **David Sears**{ XE "Sears:David (1825-)" \f "Name" \b } was born in Danby{ XE "USA, New York, Tompkins, Danby:(42.3522° N, 76.4811° W):Sears, David (1825-)" \f "Place" } in 1825.



David

- m III. **William Sears**{ XE "Sears:William (1827-)" \f "Name" \b } was born in Danby{ XE "USA, New York, Tompkins, Danby:(42.3522° N, 76.4811° W):Sears, William (1827-)" \f "Place" } in 1827.

- m IV. **John J Sears**{ XE "Sears:John J (1831-)" \f "Name" \b } was born in Danby{ XE "USA, New York, Tompkins, Danby:(42.3522° N, 76.4811° W):Sears, John J (1831-)" \f "Place" } in 1831.^[342, 344, 345, 346-347] He was buried in North Spencer, Tioga County{ XE "USA, New York, Tioga County, North Spencer: :Sears, John J (1831-)" \f "Place" }.^[342]



John

³⁴² Ancestry.com, U.S., Find A Grave Index, 1600s-Current (Provo, UT, USA, Ancestry.com Operations, Inc., 2012), Ancestry.com.

³⁴³ Ancestry.com, New York, State Census, 1865 (Provo, UT, USA, Ancestry.com Operations, Inc., 2014), Ancestry.com.

³⁴⁴ Ancestry.com, 1870 United States Federal Census (Provo, UT, USA, Ancestry.com Operations, Inc., 2009), Ancestry.com, Year: 1870; Census Place: Danby, Tompkins, New York; Roll: M593_1104; Page: 50B; Image: 170368; Family History Library Film: 552603.

³⁴⁵ Ancestry.com, New York, State Census, 1875 (Provo, UT, USA, Ancestry.com Operations, Inc., 2013), Ancestry.com.

³⁴⁶ Ancestry.com, Pennsylvania, Death Certificates, 1906-1963 (Provo, UT, USA, Ancestry.com Operations, Inc., 2014), Ancestry.com, Pennsylvania Historic and Museum Commission; Pennsylvania, USA; Certificate Number Range: 109661-112960.

More facts and events for John J Sears:

- Residence: 1865 Danby, Tompkins{ XE "USA, New York, Tompkins, Danby:(42.3522° N, 76.4811° W):Sears, John J (1831-)" \f "Place" }^[343]
Relation to Head of House: Head
- Residence: 1870 Danby{ XE "USA, New York, Tompkins, Danby:(42.3522° N, 76.4811° W):Sears, John J (1831-)" \f "Place" }^[344]
Post Office: Ithaca
- Residence: 1st June 1875 Nichols, Tioga{ XE "USA, New York, Tioga, Nichols:(42.0205° N, 76.3765° W):Sears, John J (1831-)" \f "Place" }^[345]
Relation to Head of House: Head

John J Sears married **Helen C Reed**{ XE "Reed:Helen C (ca.1837-)" \f "Name" \b \i }.^[343, 345-347] They had six children: Ely (1861-1928), Arthur (1862-1955), Erastus (1863-1949), Mary (1865-1945), Matilda (1867-1948) and Edward (1871-1913).

Helen C was born in Dryden, Tompkins,{ XE "USA, New York, Tompkins, Dryden:(42.4909° N, 76.2972° W):Reed, Helen C (ca.1837-)" \f "Place" } about 1837.^[343, 345, 346]

- m V. **Egbert Sears**{ XE "Sears:Egbert (1832-)" \f "Name" \b } was born in Danby{ XE "USA, New York, Tompkins, Danby:(42.3522° N, 76.4811° W):Sears, Egbert (1832-)" \f "Place" } in 1832.



Egbert

Egbert Sears married **Louisa Celestia Hart**{ XE "Hart:Louisa Celestia (1836-1898)" \f "Name" \b \i }. They had three children: Estella (1856-), Cynthia (1863-) and Hart (1870-).

Louisa Celestia was born in New York{ XE "USA, New York:(42.7531° N, 74.2224° W):Hart, Louisa Celestia (1836-1898)" \f "Place" } in 1836. She reached 62 years of age and died in Tompkins, New York,{ XE "USA, New York, Tompkins:(42.4514° N, 76.4747° W):Hart, Louisa Celestia (1836-1898)" \f "Place" } in 1898.

³⁴⁷ Ancestry.com, U.S., Social Security Applications and Claims Index, 1936-2007 (Provo, UT, USA, Ancestry.com Operations, Inc., 2015), Ancestry.com.

Family of Charles Sears and Clarissa Tabor{ TC "Charles Sears and Clarissa Tabor" \I 3 \f C}

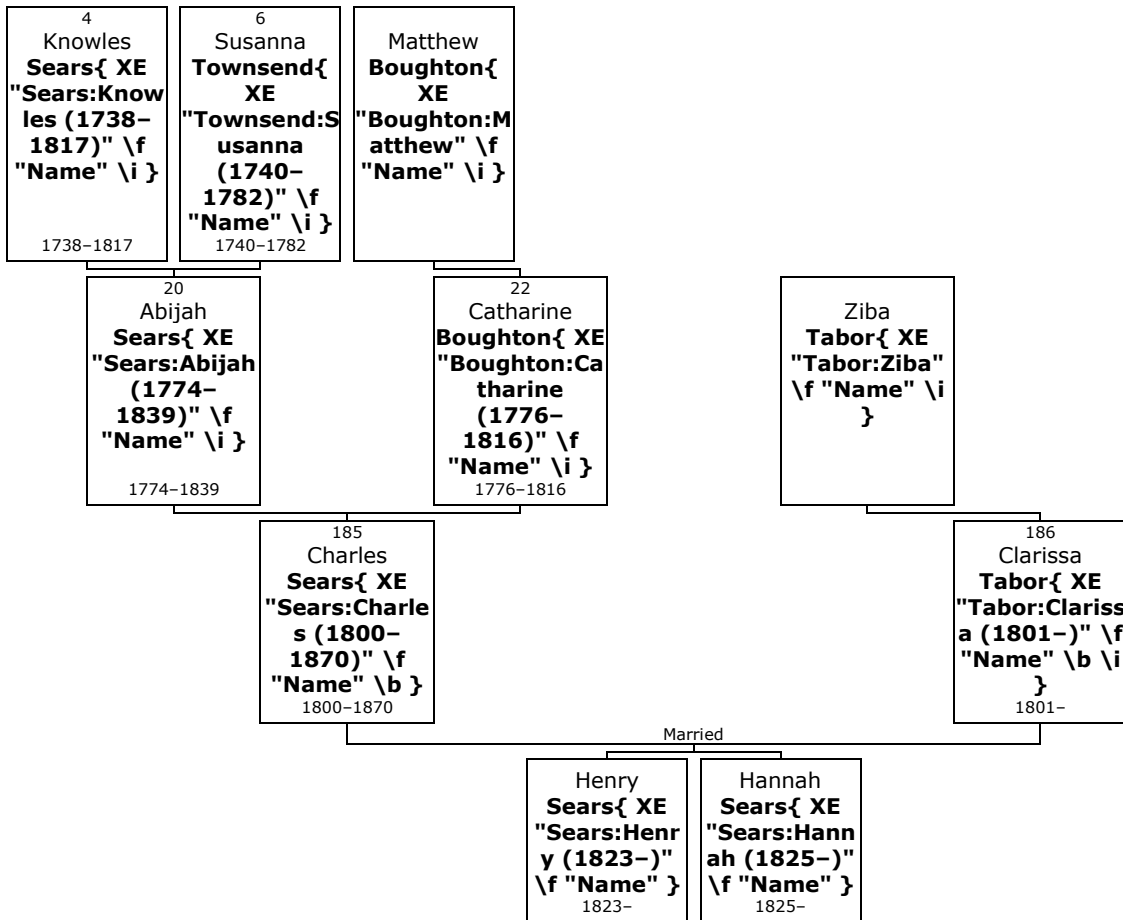

- 185.** **Charles⁵ Sears**{ XE "Sears:Charles (1800-1870)" \f "Name" \b } (*Abijah⁴, Susanna³ Townsend*) was born in 1800 in Eaton, Madison, New York, USA{ XE "USA, New York, Madison, Eaton:(42.8497° N, 75.6122° W):Sears, Charles (1800-1870)" \f "Place" }. He was the son of Abijah Sears{ XE "Sears:Abijah (1774-1839)" \f "Name" \i } (20) and Catharine Boughton{ XE "Boughton:Catharine (1776-1816)" \f "Name" \i } (22).

Charles died in Allen, Hillsdale, Michigan,{ XE "USA, Michigan, Hillsdale, Allen:(41.957° N, 84.7677° W):Sears, Charles (1800-1870)" \f "Place" } in 1870 at the age of 70.

!S.P. May No 1657 p.420 Charles Sears was a tailor. In 1821, he settled in Newark Valley, NY, where in 1823, he built the house, which since 1827, has been occupied by the Byington family. In the latter year he removed to Genoa, NY, and in Jun, 1836, to Allen, Hinsdale co., MI, where he died.

<https://www.wikitree.com/wiki/Sears-5719>

- 186.** He married **Clarissa Tabor**{ XE "Tabor:Clarissa (1801-)" \f "Name" \b \i }. They had two children: Henry (1823-) and Hannah (1825-).

Clarissa was born in perh, Newark Valley, Tioga, New York,{ XE "USA, New York, Tioga, Newark Valley, perh: :Tabor, Clarissa (1801-)" \f "Place" } in 1801. She was the daughter of Ziba Tabor{ XE "Tabor:Ziba" \f "Name" \i }.

Children of Charles Sears and Clarissa Tabor:

- m I. **Henry⁶ Sears**{ XE "Sears:Henry (1823-)" \f "Name" \b } was born in Newark Valley{ XE "USA, New York, Tioga, Newark Valley:(42.2237° N, 76.1833° W):Sears, Henry (1823-)" \f "Place" } in 1823.
- f II. **Hannah Sears**{ XE "Sears:Hannah (1825-)" \f "Name" \b } was born in Genoa, Cayuga,{ XE "USA, New York, Cayuga, Genoa:(42.6678° N, 76.5361° W):Sears, Hannah (1825-)" \f "Place" } in 1825.

Family of Mary Sears and Oliver Rewey{ TC "Mary Sears and Oliver Rewey" \I 3 \f C}

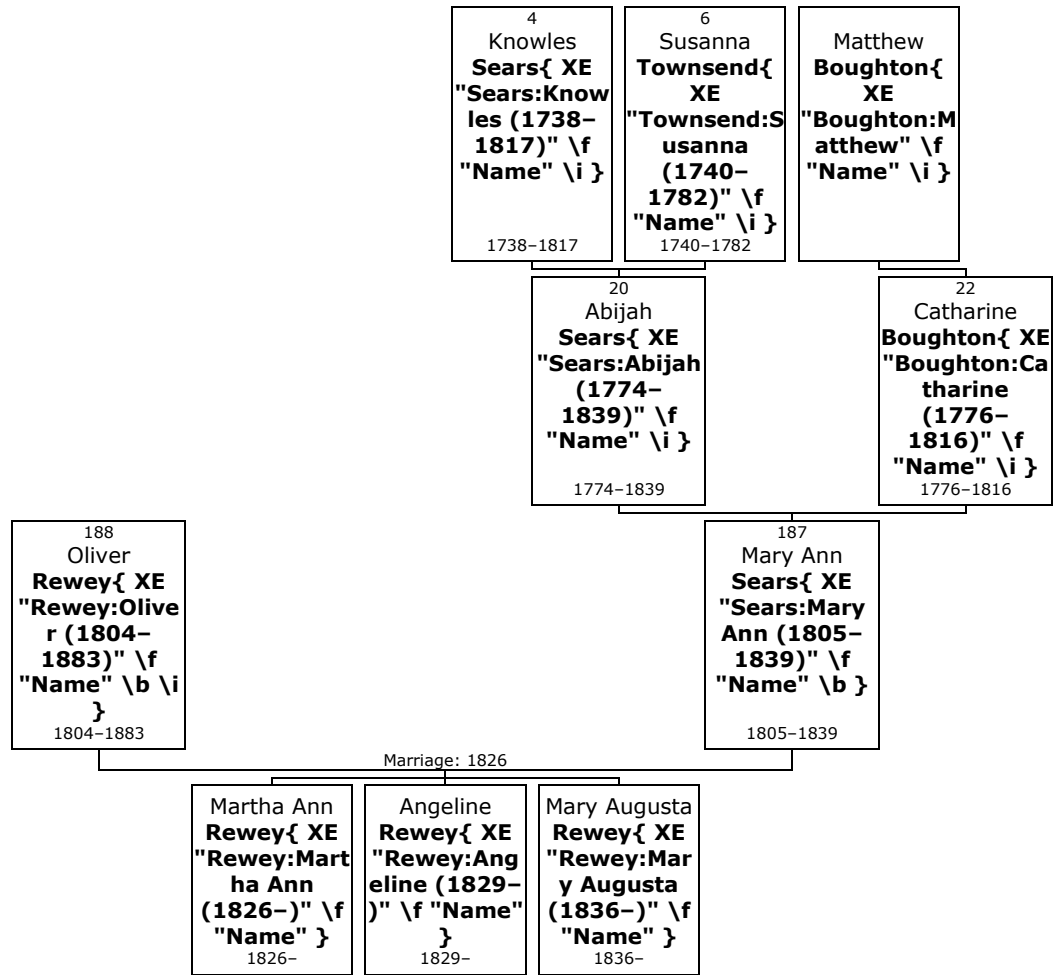

187. Mary Ann⁵ Sears{ XE "Sears:Mary Ann (1805-1839)" \f "Name" \b } (*Abijah⁴, Susanna³ Townsend*) was born on Tuesday, 16th April 1805, in Eaton, Madison, New York, USA{ XE "USA, New York, Madison, Eaton:(42.8497° N, 75.6122° W):Sears, Mary Ann (1805-1839)" \f "Place" }. She was the daughter of Abijah Sears{ XE "Sears:Abijah (1774-1839)" \f "Name" \i } (20) and Catharine Boughton{ XE "Boughton:Catharine (1776-1816)" \f "Name" \i } (22).

Mary Ann died on 18th March 1839, at the age of 33.

S P May No 1658

<https://www.wikitree.com/wiki/Sears-5721>

188. At the age of 20, Mary Ann married **Oliver Rewey**{ XE "Rewey:Oliver (1804-1883)" \f "Name" \b \i } on Sunday, 1st January 1826, in Newark Valley, Tioga,{ XE "USA, New York, Tioga, Newark Valley:(42.2237° N, 76.1833° W):Sears, Mary Ann (1805-1839)" \f "Place" } when he was 21 years old. They had three daughters: Martha (1826-), Angeline (1829-) and Mary (1836-).

Oliver was born in Stockbridge, Berkshire, Massachusetts,{ XE "USA, Massachusetts, Berkshire, Stockbridge:(42.2876° N, 73.3204° W):Rewey, Oliver (1804-1883)" \f "Place" } on Monday, 16th July 1804. He reached 78 years of age and died on 19th January 1883.

!S.P. May p.277 A blacksmith, lived in Newark Valley.

Daughters of Mary Ann Sears and Oliver Rewey:

f I. **Martha Ann⁶ Rewey**{ XE "Rewey:Martha Ann (1826-)" \f "Name" \b } was born in perh, Newark Valley,{ XE "USA, New York, Tioga, Newark Valley, perh: :Rewey, Martha Ann (1826-)" \f "Place" } on 12th December 1826.

Martha Ann married **Daniel Birchard Allen**{ XE "Allen:Daniel Birchard" \f "Name" \b \i }.
}

- f II. **Angeline Rewey**{ XE "Rewey:Angeline (1829-)" \f "Name" \b } was born in perh{ XE "USA, New York, Tioga, Newark Valley, perh: :Rewey, Angeline (1829-)" \f "Place" } on 14th January 1829.
 Angeline married **Robert Franklin Clark**{ XE "Clark:Robert Franklin" \f "Name" \b \i }.
- f III. **Mary Augusta Rewey**{ XE "Rewey:Mary Augusta (1836-)" \f "Name" \b } was born in perh{ XE "USA, New York, Tioga, Newark Valley, perh: :Rewey, Mary Augusta (1836-)" \f "Place" } on 21st April 1836.
 Mary Augusta married **Dr (unknown given name) Roberts**{ XE "Roberts:(unknown given name)" \f "Name" \b \i }.

Family of Hart Sears and Cynthia Williams{ TC "Hart Sears and Cynthia Williams" \I 3 \f C}

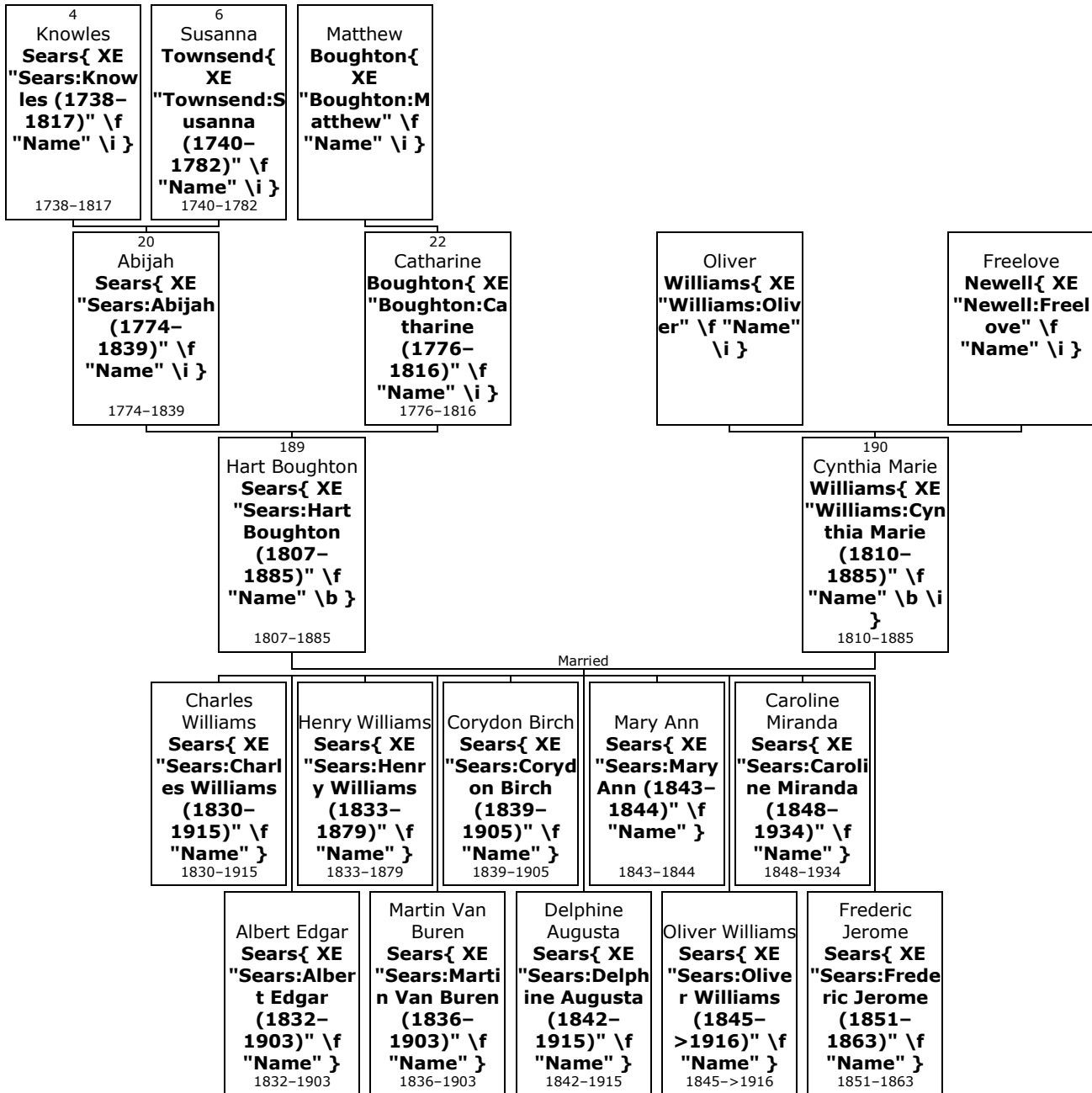

189. Hart Boughton⁵ Sears{ XE "Sears:Hart Boughton (1807-1885)" \f "Name" \b } (*Abijah*⁴, *Susanna*³ *Townsend*) was born on Saturday, 15th August 1807, in Eaton, Madison, New York, USA{ XE "USA, New

York, Madison, Eaton:(42.8497° N, 75.6122° W):Sears, Hart Boughton (1807–1885)" \f "Place" }.^[348, 349, 350-351] He was the son of Abijah Sears{ XE "Sears:Abijah (1774–1839)" \f "Name" \i } (20) and Catharine Boughton{ XE "Boughton:Catharine (1776–1816)" \f "Name" \i } (22).

Hart Boughton died in Newark Valley{ XE "USA, New York, Tioga, Newark Valley:(42.2237° N, 76.1833° W):Sears, Hart Boughton (1807–1885)" \f "Place" } on 11th May 1885, at the age of 77.^[348] He was buried in Newark Valley, Tioga County{ XE "USA, New York, Tioga County, Newark Valley:(42.2237° N, 76.1833° W):Sears, Hart Boughton (1807–1885)" \f "Place" }.^[348]

<https://www.wikitree.com/wiki/Sears-4654>

Mr Sears was a tailor; dwelt in Newark Valley til Spring of 1831; at Talcott's Corners, Venice, NY til spring of 1833, and at Northville, Genoa, NY til fall of 1834, when he returned to Newark Valley, where his widow still lives. In his early days he was a great hunter and killed many deer on the hills about Newark Valley. He joined the "Washingtonians" in 1840; was baptized and joined the Cong. Ch. in Newark Valley, Jan 2 1859

More facts and events for Hart Boughton Sears:

Residence: 1860	Newark{ XE "USA, New York, Tioga County, Newark: :Sears, Hart Boughton (1807–1885)" \f "Place" }. ^[351]
Residence: 1 st June 1875	Newark Valley, Tioga{ XE "USA, New York, Tioga, Newark Valley:(42.2237° N, 76.1833° W):Sears, Hart Boughton (1807–1885)" \f "Place" }. ^[349] Relation to Head of House: Head
Residence: 1880	Newark Valley{ XE "USA, New York, Tioga, Newark Valley:(42.2237° N, 76.1833° W):Sears, Hart Boughton (1807–1885)" \f "Place" }. ^[350] Marital status: Married; Relation to Head of House: Self

190. He married **Cynthia Marie Williams**{ XE "Williams:Cynthia Marie (1810–1885)" \f "Name" \b \i }.^[348-350] They had ten children: Charles (1830–1915), Albert (1832–1903), Henry (1833–1879), Martin (1836–1903), Corydon (1839–1905), Delphine (1842–1915), Mary (1843–1844), Oliver (1845–>1916), Caroline (1848–1934) and Frederic (1851–1863).

Cynthia Marie was born in New York{ XE "USA, New York:(42.7531° N, 74.2224° W):Williams, Cynthia Marie (1810–1885)" \f "Place" } on Tuesday, 10th April 1810.^[348-350] She was the daughter of Oliver Williams{ XE "Williams:Oliver" \f "Name" \i } and Freelove Newell{ XE "Newell:Freelove" \f "Name" \i }.

She was christened on 1st November 1820. Cynthia Marie reached 75 years of age and died on 5th December 1885.^[348] She was buried in Newark Valley, Tioga County{ XE "USA, New York, Tioga County, Newark Valley:(42.2237° N, 76.1833° W):Williams, Cynthia Marie (1810–1885)" \f "Place" }.^[348]

!S.P. May p.420 joined the Ch. in New. Vall., 2 Nov 1834, by letter from the Ch. in Genoa.

More facts and events for Cynthia Marie Williams:

Residence: 1 st June 1875	Newark Valley, Tioga{ XE "USA, New York, Tioga, Newark Valley:(42.2237° N, 76.1833° W):Williams, Cynthia Marie (1810–1885)" \f "Place" }. ^[349] Relation to Head of House: Wife
Residence: 1880	Newark Valley{ XE "USA, New York, Tioga, Newark Valley:(42.2237° N, 76.1833° W):Williams, Cynthia Marie

³⁴⁸ Ancestry.com, U.S., Find A Grave Index, 1600s-Current (Provo, UT, USA, Ancestry.com Operations, Inc., 2012), Ancestry.com.

³⁴⁹ Ancestry.com, New York, State Census, 1875 (Provo, UT, USA, Ancestry.com Operations, Inc., 2013), Ancestry.com. [Source citation includes one media item]

³⁵⁰ Ancestry.com and The Church of Jesus Christ of Latter-day Saints, 1880 United States Federal Census (Provo, UT, USA, Ancestry.com Operations Inc, 2010), Ancestry.com, Year: 1880; Census Place: Newark Valley, Tioga, New York; Roll: 937; Family History Film: 1254937; Page: 125B; Enumeration District: 209; Image: 0250. [Source citation includes one media item]

³⁵¹ Ancestry.com, New York, Compiled Census and Census Substitutes Index, 1790-1890 (Provo, UT, USA, Ancestry.com Operations Inc, 1999), Ancestry.com.

(1810–1885)" \f "Place" }^[350]

Marital status: Married; Relation to Head of House: Wife

Children of Hart Boughton Sears and Cynthia Marie Williams:

- m I. **Charles Williams⁶ Sears**{ XE "Sears:Charles Williams (1830–1915)" \f "Name" \b } was born in Newark Valley{ XE "USA, New York, Tioga, Newark Valley:(42.2237° N, 76.1833° W):Sears, Charles Williams (1830–1915)" \f "Place" } on 13th June 1830.^[348, 352, 353] He died on 8th December 1915, at the age of 85.^[348] Charles Williams was buried in Binghamton{ XE "USA, New York, Broome, Binghamton:(42.0987° N, 75.918° W):Sears, Charles Williams (1830–1915)" \f "Place" }.^[348]



Charles

More facts and events for Charles Williams Sears:

Residence: 1855 Chenango{ XE "USA, New York, Broome, Chenango:(42.1959° N, 75.9008° W):Sears, Charles Williams (1830–1915)" \f "Place" }^[353]

Relation to Head: Head

Residence: 1865 Binghamton{ XE "USA, New York, Broome, Binghamton:(42.0987° N, 75.918° W):Sears, Charles Williams (1830–1915)" \f "Place" }^[352]

Relation to Head of House: Head

Charles Williams married **Augusta R Howe**{ XE "Howe:Augusta R (1833–1880)" \f "Name" \b \i }.^[352, 353] They had three children: James (1855–1915), Frank (1858–) and Mary (1865–1890).

Augusta R was born in Delhi, Delaware,{ XE "USA, New York, Delaware, Delhi:(42.2781° N, 74.916° W):Howe, Augusta R (1833–1880)" \f "Place" } in 1833.^[352, 353] She reached 47 years of age and died on 26th July 1880.

- m II. **Albert Edgar Sears**{ XE "Sears:Albert Edgar (1832–1903)" \f "Name" \b } was born in Venice, Cayuga,{ XE "USA, New York, Cayuga, Venice:(42.7156° N, 76.5466° W):Sears, Albert Edgar (1832–1903)" \f "Place" } on 10th January 1832.^[354, 355] He died in 1903 at the age of 70.

More facts and events for Albert Edgar Sears:

Census: 1880 Whitehall{ XE "USA, Michigan, Muskegon, Whitehall:(43.41° N, 86.3487° W):Sears, Albert Edgar (1832–1903)" \f "Place" }

Residence: 1880 Whitehall{ XE "USA, Michigan, Muskegon, Whitehall:(43.41° N, 86.3487° W):Sears, Albert Edgar (1832–1903)" \f "Place" }^[354]

Marital Status: Married; Relation to Head: Self

At the age of 25, Albert Edgar Sears married **Mary Ann Allison**{ XE "Allison:Mary Ann (1833–)" \f "Name" \b \i } on Wednesday, 20th May 1857, in Grimsby, Niagara, Ontario, Canada,{ XE "Canada, Ontario, Niagara, Grimsby:(43.2° N, 79.55° W):Sears, Albert Edgar (1832–1903)" \f "Place" } when she was 23 years old.^[354–356] They had five

³⁵² Ancestry.com, New York, State Census, 1865 (Provo, UT, USA, Ancestry.com Operations, Inc., 2014), Ancestry.com.

³⁵³ Ancestry.com, New York, State Census, 1855 (Provo, UT, USA, Ancestry.com Operations, Inc., 2013), Ancestry.com.

³⁵⁴ Ancestry.com and The Church of Jesus Christ of Latter-day Saints, 1880 United States Federal Census (Provo, UT, USA, Ancestry.com Operations Inc, 2010), Ancestry.com, Year: 1880; Census Place: Whitehall, Muskegon, Michigan; Roll: 597; Family History Film: 1254597; Page: 44A; Enumeration District: 185.

³⁵⁵ Ancestry.com, Washington, Select Death Certificates, 1907-1960 (Provo, UT, USA, Ancestry.com Operations, Inc., 2014), Ancestry.com.

³⁵⁶ Ancestry.com, 1910 United States Federal Census (Provo, UT, USA, Ancestry.com Operations Inc, 2006), Ancestry.com, Year: 1910; Census Place: Minneapolis Ward 9, Hennepin, Minnesota; Roll: T624_704; Page: 9B; Enumeration District: 0159;

children: Louisa (1858–), Charles (1860–1933), John (1864–), Carrie (1867–1937) and Franklin (1870–1950).

Mary Ann was born in Nelson, British Columbia, { XE "Canada, British Columbia, Nelson:(49.4931° N, 117.2948° W):Allison, Mary Ann (1833–)" \f "Place" } on Thursday, 24th October 1833.^[354, 356]

father b. England, mother b. Canada

- m III. **Henry Williams Sears**{ XE "Sears:Henry Williams (1833–1879)" \f "Name" \b } was born in Genoa { XE "USA, New York, Cayuga, Genoa:(42.6678° N, 76.5361° W):Sears, Henry Williams (1833–1879)" \f "Place" } on 9th December 1833. He died in Burlington, Des Moines, Iowa, { XE "USA, Iowa, Des Moines, Burlington:(40.8075° N, 91.1129° W):Sears, Henry Williams (1833–1879)" \f "Place" } on 25th February 1879, at the age of 45.

Henry Williams Sears married **Angeline Dean**{ XE "Dean:Angeline (1829–1881)" \f "Name" \b \i } in 1853. They had no known children.

Angeline was born in Newark Valley, Tioga, New York, { XE "USA, New York, Tioga, Newark Valley:(42.2237° N, 76.1833° W):Dean, Angeline (1829–1881)" \f "Place" } on Wednesday, 9th December 1829. She was the daughter of Stafford Dean { XE "Dean:Stafford (1803–)" \f "Name" \i } and Abigail Warren { XE "Warren:Abigail (1807–)" \f "Name" \i }.

Angeline reached 51 years of age and died in 1881.

D.S.P.

- m IV. **Martin Van Buren Sears**{ XE "Sears:Martin Van Buren (1836–1903)" \f "Name" \b } was born in Newark Valley, Tioga, { XE "USA, New York, Tioga, Newark Valley:(42.2237° N, 76.1833° W):Sears, Martin Van Buren (1836–1903)" \f "Place" } on 1st April 1836.^[357, 358] He died in 1903 at the age of 66.^[358]

More facts and events for Martin Van Buren Sears:

Residence: 1850 Tioga { XE "USA, New York, Tioga:(42.1668° N, 76.3029° W):Sears, Martin Van Buren (1836–1903)" \f "Place" }^[358]

Residence: 1870 Newark Valley, Tioga { XE "USA, New York, Tioga, Newark Valley:(42.2237° N, 76.1833° W):Sears, Martin Van Buren (1836–1903)" \f "Place" }^[358]

Residence: 1880 Newark Valley { XE "USA, New York, Tioga, Newark Valley:(42.2237° N, 76.1833° W):Sears, Martin Van Buren (1836–1903)" \f "Place" }^[357, 358]

Marital Status: Married; Relation to Head: Self

Martin Van Buren Sears married **Sophronia Moore**{ XE "Moore:Sophronia (1838–1902)" \f "Name" \b \i } in March 1861.^[357, 359] They had two children: Lizzie (1864–) and Fred (1870–1916).

Sophronia was born in perh, Newark Valley, { XE "USA, New York, Tioga, Newark Valley, perh: :Moore, Sophronia (1838–1902)" \f "Place" } on Sunday, 12th August 1838.^[357, 359]

FHL microfilm: 1374717.

[Source citation includes one media item]

³⁵⁷ Ancestry.com and The Church of Jesus Christ of Latter-day Saints, 1880 United States Federal Census (Provo, UT, USA, Ancestry.com Operations Inc, 2010), Ancestry.com, Year: 1880; Census Place: Newark Valley, Tioga, New York; Roll: 937; Family History Film: 1254937; Page: 147D; Enumeration District: 210.

³⁵⁸ "Ancestry Family Tree", Record for Frederick "Fred" J Sears-<https://www.ancestry.com/family-tree/tree/30794454/person/180030329106>.
<https://familysearch.org/ark:/61903/4:1:K4LC-CDQ>.

³⁵⁹ Ancestry.com, 1900 United States Federal Census (Provo, UT, USA, Ancestry.com Operations Inc, 2004), Ancestry.com, Year: 1900; Census Place: Newark Valley, Tioga, New York; Roll: 1168; Page: 1B; Enumeration District: 0125; FHL microfilm: 1241168.

[Source citation includes one media item]

She was the daughter of Daniel Moore{ XE "Moore:Daniel" \f "Name" \i } and Electa Porter{ XE "Porter:Electa" \f "Name" \i }.

Sophronia reached 64 years of age and died in Newark Valley{ XE "USA, New York, Tioga, Newark Valley:(42.2237° N, 76.1833° W):Moore, Sophronia (1838–1902)" \f "Place" } on 28th August 1902. She was buried in Newark Valley{ XE "USA, New York, Tioga, Newark Valley:(42.2237° N, 76.1833° W):Moore, Sophronia (1838–1902)" \f "Place" }.

m

V. **Corydon Birch Sears**{ XE "Sears:Corydon Birch (1839–1905)" \f "Name" \b } was born in Newark Valley{ XE "USA, New York, Tioga, Newark Valley:(42.2237° N, 76.1833° W):Sears, Corydon Birch (1839–1905)" \f "Place" } on 23rd December 1839.^[348, 360] He died in New York{ XE "USA, New York:(42.7531° N, 74.2224° W):Sears, Corydon Birch (1839–1905)" \f "Place" } in 1905 at the age of 65.^[348, 360]



Corydon

Corydon Birch was buried in Johnson City, Broome County, New York{ XE "USA, New York, Broome County, Johnson City:(42.1156° N, 75.9592° W):Sears, Corydon Birch (1839–1905)" \f "Place" }.^[348] His estate was probated on 14th December 1905, in Broome{ XE "USA, New York, Broome:(42.1642° N, 75.8197° W):Sears, Corydon Birch (1839–1905)" \f "Place" }.^[360]

Corydon Birch Sears married **Mary O Day**{ XE "Day:Mary O (1843–)" \f "Name" \b \i }. They had no known children.

Mary O was born in perh, Newark Valley, Tioga,{ XE "USA, New York, Tioga, Newark Valley, perh: :Day, Mary O (1843–)" \f "Place" } in 1843.

f

VI. **Delphine Augusta Sears**{ XE "Sears:Delphine Augusta (1842–1915)" \f "Name" \b } was born in Newark Valley{ XE "USA, New York, Tioga, Newark Valley:(42.2237° N, 76.1833° W):Sears, Delphine Augusta (1842–1915)" \f "Place" } on 9th April 1842.^[348–350] She died on 2nd February 1915, at the age of 72.^[348] Delphine Augusta was buried in Newark Valley, Tioga County{ XE "USA, New York, Tioga County, Newark Valley:(42.2237° N, 76.1833° W):Sears, Delphine Augusta (1842–1915)" \f "Place" }.^[348]

More facts and events for Delphine Augusta Sears:

Residence: 1st June 1875 Newark Valley, Tioga{ XE "USA, New York, Tioga, Newark Valley:(42.2237° N, 76.1833° W):Sears, Delphine Augusta (1842–1915)" \f "Place" }.^[349]

Relation to Head of House: Daughter

Residence: 1880 Newark Valley{ XE "USA, New York, Tioga, Newark Valley:(42.2237° N, 76.1833° W):Sears, Delphine Augusta (1842–1915)" \f "Place" }.^[350]

Marital status: Widowed; Relation to Head of House: Daughter

At the age of 24, Delphine Augusta Sears married **Charles Pyncheon Lyman**{ XE "Lyman:Charles Pyncheon (1831–1868)" \f "Name" \b \i } on Tuesday, 19th February 1867, in Muskegon, Michigan,{ XE "USA, Michigan, Muskegon:(43.2871° N, 86.4465° W):Sears, Delphine Augusta (1842–1915)" \f "Place" } when he was 35 years old. They had one son: Charles (1868–).

Charles Pyncheon was born in perh, Caneadea, Allegany, New York,{ XE "USA, New York, Allegany, Caneadea, perh: :Lyman, Charles Pyncheon (1831–1868)" \f "Place" } on Friday, 12th August 1831. He was the son of Henry D Lyman{ XE "Lyman:Henry D (1805–)" \f "Name" \i } and Sophia Buckman{ XE "Buckman: Sophia (1809–)" \f "Name" \i }.

³⁶⁰ Ancestry.com, New York, Wills and Probate Records, 1659-1999 (Provo, UT, USA, Ancestry.com Operations, Inc., 2015), Ancestry.com, Wills of Broome County, New York, 1806-1906; Author: New York. Surrogate's Court (Broome County); Probate Place: Broome, New York.

Charles Pyncheon reached 36 years of age and died in Chicago, Cook, Illinois,{ XE "USA, Illinois, Cook, Chicago:(41.85° N, 87.6501° W):Lyman, Charles Pyncheon (1831-1868)" \f "Place" } on 4th March 1868.

!S.P. May p.421 was a lumber dealer in Chicago, IL where he died having been thrown from his carriage.

At the age of 39, Delphine Augusta Sears married **Lucius Wells Spalding**{ XE "Spalding:Lucius Wells (1832-)" \f "Name" \b \i } on Thursday, 6th October 1881, when he was 49 years old. They had no known children.

Lucius Wells was born in perh, Newark Valley, Tioga, New York,{ XE "USA, New York, Tioga, Newark Valley, perh: :Spalding, Lucius Wells (1832-)" \f "Place" } on Sunday, 9th September 1832. He was the son of Moses Spalding{ XE "Spalding:Moses" \f "Name" \i } and Eunice Johnson{ XE "Johnson:Eunice" \f "Name" \i }.

!S.P. May p.421 a farmer in New. Vall.

- f VII. **Mary Ann Sears**{ XE "Sears:Mary Ann (1843-1844)" \f "Name" \b } was born in Newark Valley{ XE "USA, New York, Tioga, Newark Valley:(42.2237° N, 76.1833° W):Sears, Mary Ann (1843-1844)" \f "Place" } on 28th October 1843. She died on 29th April 1844.
- m VIII. **Oliver Williams Sears**{ XE "Sears:Oliver Williams (1845->1916)" \f "Name" \b } was born in Newark Valley{ XE "USA, New York, Tioga, Newark Valley:(42.2237° N, 76.1833° W):Sears, Oliver Williams (1845->1916)" \f "Place" } on 13th June 1845.^[361, 362, 363, 364-365] He died after 1916.

More facts and events for Oliver Williams Sears:

- Residence: 1900 Ward 7{ XE "USA, New York, Broome, Binghamton, Ward 7: :Sears, Oliver Williams (1845->1916)" \f "Place" }^[363]
Marital Status: Married; Relation to Head: Head
- Residence: 1910 Ward 7{ XE "USA, New York, Broome, Binghamton, Ward 7: :Sears, Oliver Williams (1845->1916)" \f "Place" }^[361]
Marital Status: Married; Relation to Head of House: Head
- Residence: 1st June 1915 Ward 7{ XE "USA, New York, Broome, Binghamton, Ward 7: :Sears, Oliver Williams (1845->1916)" \f "Place" }^[362]
Relation to Head of House: Head
- Residence: 1916 Binghamton{ XE "USA, New York, Broome, Binghamton:(42.0987° N, 75.918° W):Sears, Oliver Williams (1845->1916)" \f "Place" }^[365]
- Residence: 1st June 1925 Ward 7, Binghamton{ XE "USA, New York,

³⁶¹ Ancestry.com, 1910 United States Federal Census (Provo, UT, USA, Ancestry.com Operations Inc, 2006), Ancestry.com, Year: 1910; Census Place: Binghamton Ward 7, Broome, New York; Roll: T624_925; Page: 15B; Enumeration District: 0023; FHL microfilm: 1374938.

³⁶² Ancestry.com, New York, State Census, 1915 (Provo, UT, USA, Ancestry.com Operations, Inc., 2012), Ancestry.com, New York State Archives; Albany, New York; State Population Census Schedules, 1915; Election District: 03; Assembly District: 01; City: Binghamton Ward 07; County: Broome; Page: 03.

³⁶³ Ancestry.com, 1900 United States Federal Census (Provo, UT, USA, Ancestry.com Operations Inc, 2004), Ancestry.com, Year: 1900; Census Place: Binghamton Ward 7, Broome, New York; Roll: 1009; Page: 1B; Enumeration District: 0017; FHL microfilm: 1241009.

³⁶⁴ Ancestry.com, New York, State Census, 1925 (Provo, UT, USA, Ancestry.com Operations, Inc., 2012), Ancestry.com, New York State Archives; Albany, New York; State Population Census Schedules, 1925; Election District: 01; Assembly District: 02; City: Binghamton Ward 07; County: Broome; Page: 14.

³⁶⁵ Ancestry.com, U.S. City Directories, 1821-1989 (Provo, UT, USA, Ancestry.com Operations, Inc., 2011), Ancestry.com.

Broome, Binghamton, Ward 7: :Sears, Oliver Williams (1845->1916)" \f "Place" }^[364]
Relation to Head: Head

Oliver Williams Sears married **Georgianna Bartlett**{ XE "Bartlett:Georgianna (1853-)" \f "Name" \b \i } in 1875.^[361-365] They had two children: Sarah (1875-) and Robert (1879-1926).

Georgianna was born in perh{ XE "USA, New York, Broome, Binghamton, perh: :Bartlett, Georgianna (1853-)" \f "Place" } in 1853.^[361-364] She was the daughter of Robert Bartlett{ XE "Bartlett:Robert" \f "Name" \i } and (unknown given name) Bartlett{ XE "Bartlett:(unknown given name)" \f "Name" \i }.

- f IX. **Caroline Miranda Sears**{ XE "Sears:Caroline Miranda (1848-1934)" \f "Name" \b } was born in Newark Valley{ XE "USA, New York, Tioga, Newark Valley:(42.2237° N, 76.1833° W):Sears, Caroline Miranda (1848-1934)" \f "Place" } on 3rd February 1848.^[348, 366] She died in Fayetteville, Onondaga County,{ XE "USA, New York, Onondaga County, Fayetteville:(43.0298° N, 76.0043° W):Sears, Caroline Miranda (1848-1934)" \f "Place" } on 13th October 1934, at the age of 86.^[348] Caroline Miranda was buried in Oakwood Cemetery, Syracuse, Onondaga{ XE "USA, New York, Onondaga, Syracuse, Oakwood Cemetery: :Sears, Caroline Miranda (1848-1934)" \f "Place" }.^[348]



Caroline

More facts and events for Caroline Miranda Sears:

Residence: 1905 Ward 5{ XE "USA, New York, Onondaga, Syracuse, Ward 5: :Sears, Caroline Miranda (1848-1934)" \f "Place" }^[366]
Age: 55; RelationToHead: Wife

At the age of 27, Caroline Miranda Sears married **Charles Gouder Estabrook**{ XE "Estabrook:Charles Gouder (1850-1880)" \f "Name" \b \i } on Thursday, 18th November 1875, in Binghamton, Broome,{ XE "USA, New York, Broome, Binghamton:(42.0987° N, 75.918° W):Sears, Caroline Miranda (1848-1934)" \f "Place" } when he was 25 years old. They had two sons: William (1877-) and Charles (1879-1975).

Charles Gouder was born in Great Valley, Cattaraugus,{ XE "USA, New York, Cattaraugus, Great Valley:(42.2144° N, 78.6367° W):Estabrook, Charles Gouder (1850-1880)" \f "Place" } on Sunday, 6th October 1850. He was the son of Thaddeus Estabrook{ XE "Estabrook:Thaddeus (1824-)" \f "Name" \i } and Eliza Buck{ XE "Buck:Eliza (1828-)" \f "Name" \i }.

Charles Gouder reached 29 years of age and died on 2nd August 1880.

!S.P. May p.421 grad Univ Penn, 1871; spent a year in European travel and study and then settled in Binghamton, where he had a fine practice and took high rank as a physician

Caroline Miranda Sears married **Theron E Barnum**{ XE "Barnum:Theron E (1853-1920)" \f "Name" \b \i }.^[366] They had one son: Jerome (1889-1965).

Theron E was born in 1853.^[366] He reached 67 years of age and died in 1920.

- m X. **Frederic Jerome Sears**{ XE "Sears:Frederic Jerome (1851-1863)" \f "Name" \b } was born in Newark Valley{ XE "USA, New York, Tioga, Newark Valley:(42.2237° N, 76.1833° W):Sears, Frederic Jerome (1851-1863)" \f "Place" } on 18th May 1851. He died on 5th October 1863, at the age of 12.

³⁶⁶ Ancestry.com, New York, State Census, 1905 (Provo, UT, USA, Ancestry.com Operations, Inc., 2014), Ancestry.com, New York State Archives; Albany, New York; State Population Census Schedules, 1905; Election District: E.D. 02; City: Syracuse Ward 05; County: Onondaga; Page: 19. Record for Jerome D Barnum.
<http://search.ancestry.com/cgi-bin/sse.dll?db=7364&h=903657&indiv=try>.

Family of Gregory and Levi Benedict{ TC "Gregory and Levi Benedict" \I 3 \f C}

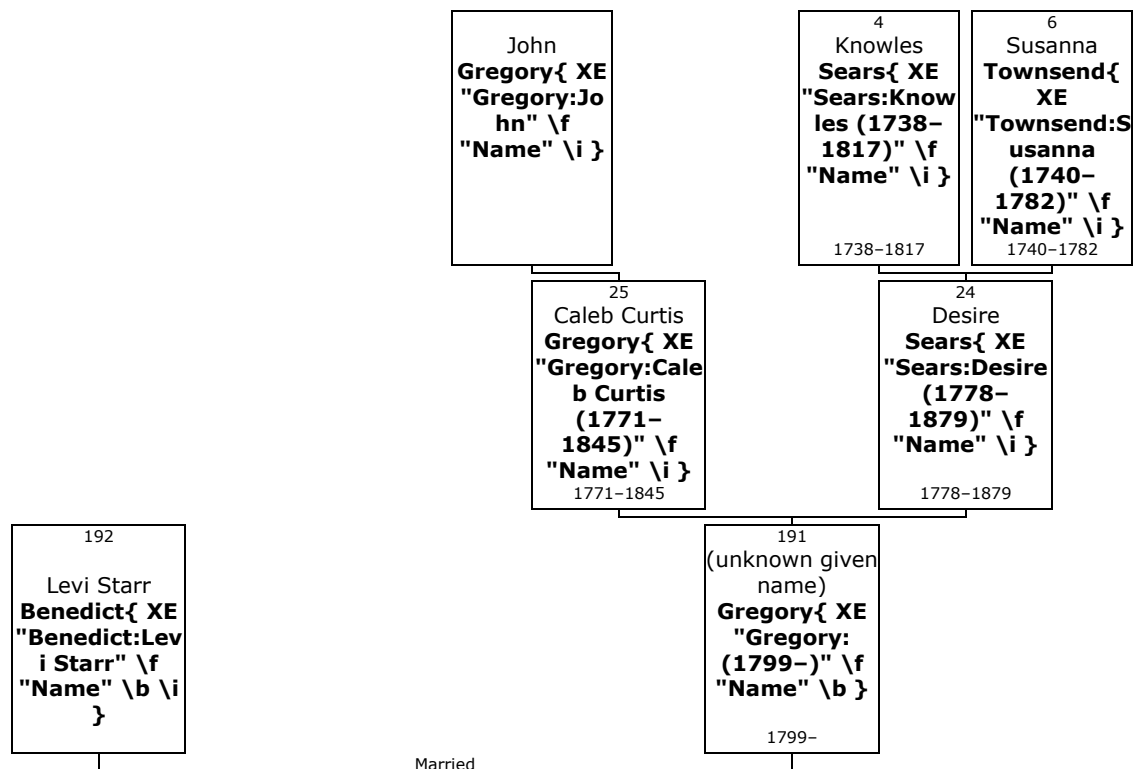

- 191.** **(unknown given name)⁵ Gregory**{ XE "Gregory: (1799-)" \f "Name" \b } (*Desire⁴ Sears, Susanna³ Townsend*) was born in 1799. She was the daughter of **Caleb Curtis Gregory**{ XE "Gregory:Caleb Curtis (1771-1845)" \f "Name" \i } (25) and **Desire Sears**{ XE "Sears:Desire (1778-1879)" \f "Name" \i } (24).
- 192.** She married **Levi Starr Benedict**{ XE "Benedict:Levi Starr" \f "Name" \b \i }.

Family of Adeline Gregory and James St. John{ TC "Adeline Gregory and James St. John" \I 3 \f C}

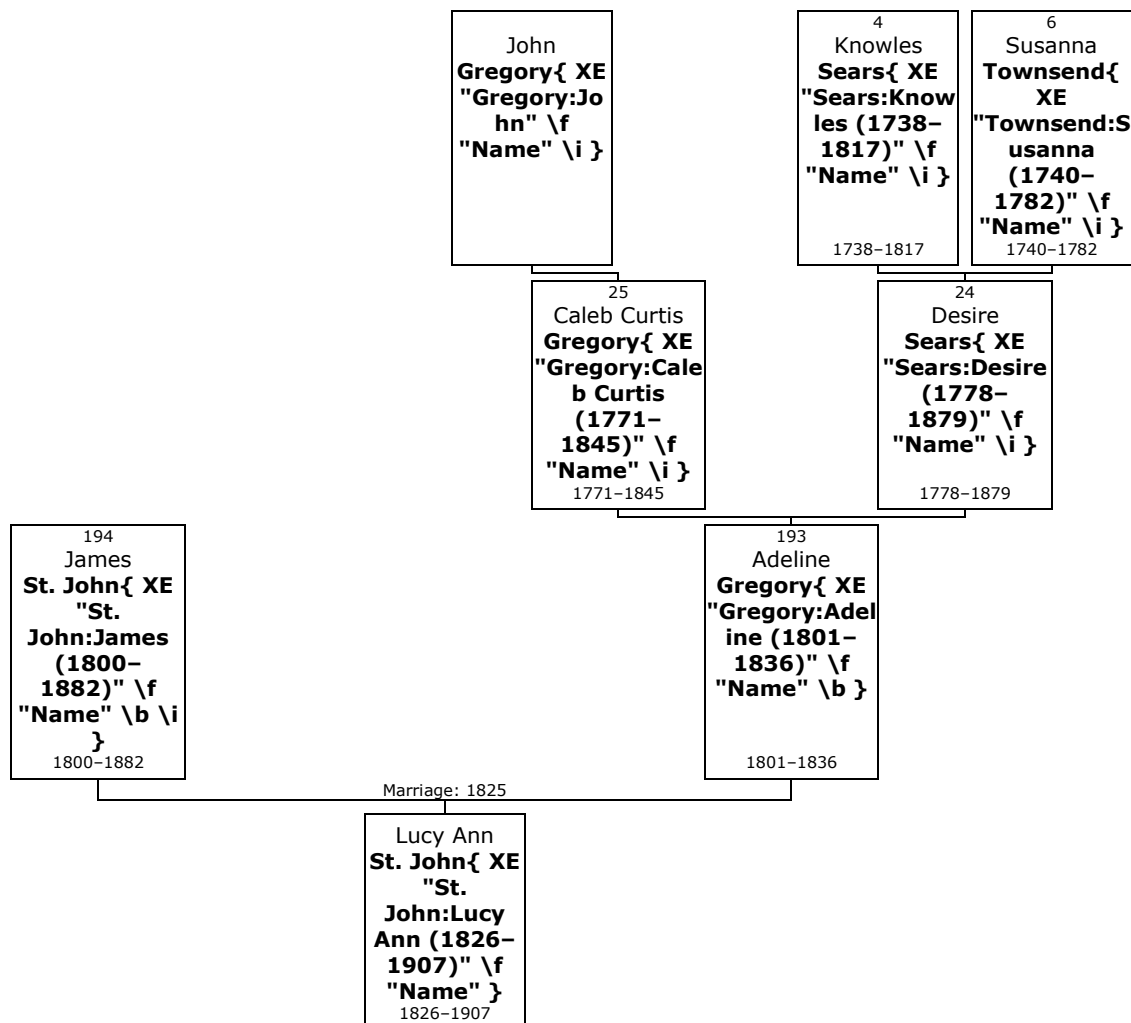

- 193.** **Adeline⁵ Gregory**{ XE "Gregory:Adeline (1801-1836)" \f "Name" \b } (*Desire⁴ Sears, Susanna³ Townsend*) was born on Saturday, 21st February 1801, in Danbury, Fairfield, Connecticut, USA{ XE "USA, Connecticut, Fairfield, Danbury:(41.3948° N, 73.454° W):Gregory, Adeline (1801-1836)" \f "Place" }. She was the daughter of Caleb Curtis Gregory{ XE "Gregory:Caleb Curtis (1771-1845)" \f "Name" \i } (25) and Desire Sears{ XE "Sears:Desire (1778-1879)" \f "Name" \i } (24).

Adeline died in Jackson, Michigan,{ XE "USA, Michigan, Jackson:(42.2479° N, 84.4245° W):Gregory, Adeline (1801-1836)" \f "Place" } on 17th December 1836, at the age of 35.

- 194.** Adeline married **James St. John**{ XE "St. John:James (1800-1882)" \f "Name" \b \i } in 1825. They had one daughter: Lucy (1826-1907).

James was born at Ridgebury in Ridgefield, Fairfield, Connecticut,{ XE "USA, Connecticut, Fairfield, Ridgefield:(41.2815° N, 73.4982° W):St. John, James (1800-1882)" \f "Place" } on Friday, 4th April 1800. He reached 82 years of age and died on 11th September 1882.

More facts and events for James St. John:

Residence: 1860 Columbia, Jackson, Michigan{ XE "USA, Michigan, Jackson, Columbia:(42.1039° N, 84.2867° W):St. John, James (1800-1882)" \f "Place" }

Residence: 1870 Michigan{ XE "USA, Michigan:(44.5917° N, 85.025° W):St. John, James (1800-1882)" \f "Place" }

Daughter of Adeline Gregory and James St. John:

f I. **Lucy Ann⁶ St. John**{ XE "St. John:Lucy Ann (1826–1907)" \f "Name" \b } was born in Michigan{ XE "USA, Michigan:(44.5917° N, 85.025° W):St. John, Lucy Ann (1826–1907)" \f "Place" } on 25th May 1826.^[367, 368, 369, 370, 371, 372, 373, 374, 375, 376, 377, 378, 379, 380–381] She died on 22nd March 1907, at the age of 80.^[367]

At the age of 27, Lucy Ann married **Miles Justine Knowlton**{ XE "Knowlton:Miles Justine (1825–1874)" \f "Name" \b \i } on Sunday, 10th July 1853, in Michigan{ XE

- ³⁶⁷ FamilySearch.org, FamilySearch Family Tree, FamilySearch, "Family Tree," database, <i>FamilySearch</i> (http://familysearch.org : modified 18 August 2018, 15:44), entry for Lucy Ann St. John(PID https://familysearch.org/ark:/61903/4:1:LCZS-TTY); contributed by various users. PersonID LCZS-TTY. Lucy Ann St. John. https://familysearch.org/ark:/61903/4:1:LCZS-TTY.
- ³⁶⁸ FamilySearch.org, FamilySearch Family Tree, FamilySearch, "Connecticut Marriages, 1630-1997," database, <i>FamilySearch</i> (https://familysearch.org/ark:/61903/1:1:F7P7-R2J : 11 February 2018), Miles J. Knowlton and Lucy St. John, 10 Jul 1853; citing Connecticut, United States, reference ; FHL microfilm 3,297. Lucy St. John, "Connecticut Marriages, 1630-1997". https://familysearch.org/ark:/61903/1:1:F7P7-R2J.
- ³⁶⁹ FamilySearch.org, FamilySearch Family Tree, FamilySearch, "Connecticut Marriages, 1630-1997", database, <i>FamilySearch</i> (https://familysearch.org/ark:/61903/1:1:F7PV-XQY : 17 March 2018), Miles J. Knowlton and Lucy A. St. John, 1853. Lucy A. St. John, "Connecticut Marriages, 1630-1997". https://familysearch.org/ark:/61903/1:1:F7PV-XQY.
- ³⁷⁰ FamilySearch.org, FamilySearch Family Tree, FamilySearch, "Connecticut Marriages, 1630-1997", database, <i>FamilySearch</i> (https://familysearch.org/ark:/61903/1:1:F7PV-BY4 : 17 March 2018), Miles J. Knowlton and Lucy A. St. John, 1853. Lucy A. St. John, "Connecticut Marriages, 1630-1997". https://familysearch.org/ark:/61903/1:1:F7PV-BY4.
- ³⁷¹ FamilySearch.org, FamilySearch Family Tree, FamilySearch, "Connecticut Marriages, 1630-1997," database, <i>FamilySearch</i> (https://familysearch.org/ark:/61903/1:1:F7P7-R2K : 11 February 2018), Miles J. Knowlton and Lucy A. St. John, 10 Jul 1853; citing Connecticut, United States, reference ; FHL microfilm 3,297. Lucy A. St. John, "Connecticut Marriages, 1630-1997". https://familysearch.org/ark:/61903/1:1:F7P7-R2K.
- ³⁷² FamilySearch.org, FamilySearch Family Tree, FamilySearch, "California Death Index, 1940-1997," database, <i>FamilySearch</i> (https://familysearch.org/ark:/61903/1:1:VPM-8Q6 : 26 November 2014), Stjohn in entry for Antha Knowlton Miller, 22 Jan 1958; Department of Public Health Services, Sacramento. Stjohn in entry for Antha Knowlton Miller, "California Death Index, 1940-1997". https://familysearch.org/ark:/61903/1:1:VPM-8Q6.
- ³⁷³ FamilySearch.org, FamilySearch Family Tree, FamilySearch, "Connecticut Marriages, 1630-1997," database, <i>FamilySearch</i> (https://familysearch.org/ark:/61903/1:1:F7P7-T3L : 11 February 2018), Miles J. Knowlton and A. St. John, 05 Aug 1853; citing Connecticut, United States, reference ; FHL microfilm 3,297. A. St. John, "Connecticut Marriages, 1630-1997". https://familysearch.org/ark:/61903/1:1:F7P7-T3L.
- ³⁷⁴ FamilySearch.org, FamilySearch Family Tree, FamilySearch, "Connecticut Marriages, 1630-1997", database, <i>FamilySearch</i> (https://familysearch.org/ark:/61903/1:1:F7LX-C28 : 17 March 2018), Miles J. Knowlton and Lucy A. St. John, 1883. Lucy A. St. John, "Connecticut Marriages, 1630-1997". https://familysearch.org/ark:/61903/1:1:F7LX-C28.
- ³⁷⁵ FamilySearch.org, FamilySearch Family Tree, FamilySearch, "Connecticut Marriages, 1630-1997", database, <i>FamilySearch</i> (https://familysearch.org/ark:/61903/1:1:F7LK-5YR : 17 March 2018), Miles J. Knowlton and Lucy A. St. John, 1853. Lucy A. St. John, "Connecticut Marriages, 1630-1997". https://familysearch.org/ark:/61903/1:1:F7LK-5YR.
- ³⁷⁶ FamilySearch.org, FamilySearch Family Tree, FamilySearch, "Connecticut Marriages, 1630-1997", database, <i>FamilySearch</i> (https://familysearch.org/ark:/61903/1:1:F7LK-L3L : 17 March 2018), Miles J. Knowlton and Lucy A. St. John, 1853. Lucy A. St. John, "Connecticut Marriages, 1630-1997". https://familysearch.org/ark:/61903/1:1:F7LK-L3L.
- ³⁷⁷ FamilySearch.org, FamilySearch Family Tree, FamilySearch, "Connecticut Marriages, 1630-1997", database, <i>FamilySearch</i> (https://familysearch.org/ark:/61903/1:1:F7LX-D3K : 17 March 2018), Miles J. Knowlton and Lucy A. St. John, 1853. Lucy A. St. John, "Connecticut Marriages, 1630-1997". https://familysearch.org/ark:/61903/1:1:F7LX-D3K.
- ³⁷⁸ FamilySearch.org, FamilySearch Family Tree, FamilySearch, "Connecticut Marriages, 1630-1997," database, <i>FamilySearch</i> (https://familysearch.org/ark:/61903/1:1:F7P7-T3K : 11 February 2018), Miles J. Knowlton and Lucy A. St. John, 30 Jul 1853; citing Connecticut, United States, reference ; FHL microfilm 3,29. Lucy A. St. John, "Connecticut Marriages, 1630-1997". https://familysearch.org/ark:/61903/1:1:F7P7-T3K.
- ³⁷⁹ FamilySearch.org, FamilySearch Family Tree, FamilySearch, "Connecticut Marriages, 1630-1997," database, <i>FamilySearch</i> (https://familysearch.org/ark:/61903/1:1:F7P7-T3F : 11 February 2018), Miles J. Knowlton and Lucy A. St. John, 26 Jul 1853; citing Connecticut, United States, reference ; FHL microfilm 3,29. Lucy A. St. John, "Connecticut Marriages, 1630-1997". https://familysearch.org/ark:/61903/1:1:F7P7-T3F.
- ³⁸⁰ FamilySearch.org, FamilySearch Family Tree, FamilySearch, "Connecticut Marriages, 1630-1997," database, <i>FamilySearch</i> (https://familysearch.org/ark:/61903/1:1:F7P7-T3J : 11 February 2018), Miles J. Knowlton and Lucy A. St. John, 30 Jul 1853; citing Connecticut, United States, reference ; FHL microfilm 3,29. Lucy A. St. John, "Connecticut Marriages, 1630-1997". https://familysearch.org/ark:/61903/1:1:F7P7-T3J.
- ³⁸¹ FamilySearch.org, FamilySearch Family Tree, FamilySearch, "Connecticut Marriages, 1630-1997," database, <i>FamilySearch</i> (https://familysearch.org/ark:/61903/1:1:F7P7-R2L : 11 February 2018), Miles J. Knowlton and Lucy A. St. John, 23 Jul 1853; citing Connecticut, United States, reference ; FHL microfilm 3,297. Lucy A. St. John, "Connecticut Marriages, 1630-1997". https://familysearch.org/ark:/61903/1:1:F7P7-R2L.

"USA, Michigan:(44.5917° N, 85.025° W):St. John, Lucy Ann (1826–1907)" \f "Place" } when he was 28 years old.^[367] They had one daughter: Antha (1868–1958).

Miles Justine was born in Vermont{ XE "USA, Vermont:(43.8726° N, 71.55° W):Knowlton, Miles Justine (1825–1874)" \f "Place" } on Monday, 28th February 1825. He reached 49 years of age and died on 10th September 1874.

Family of Edwin Sears and Marietta Jarvis{ TC "Edwin Sears and Marietta Jarvis" \I 3 \f C}

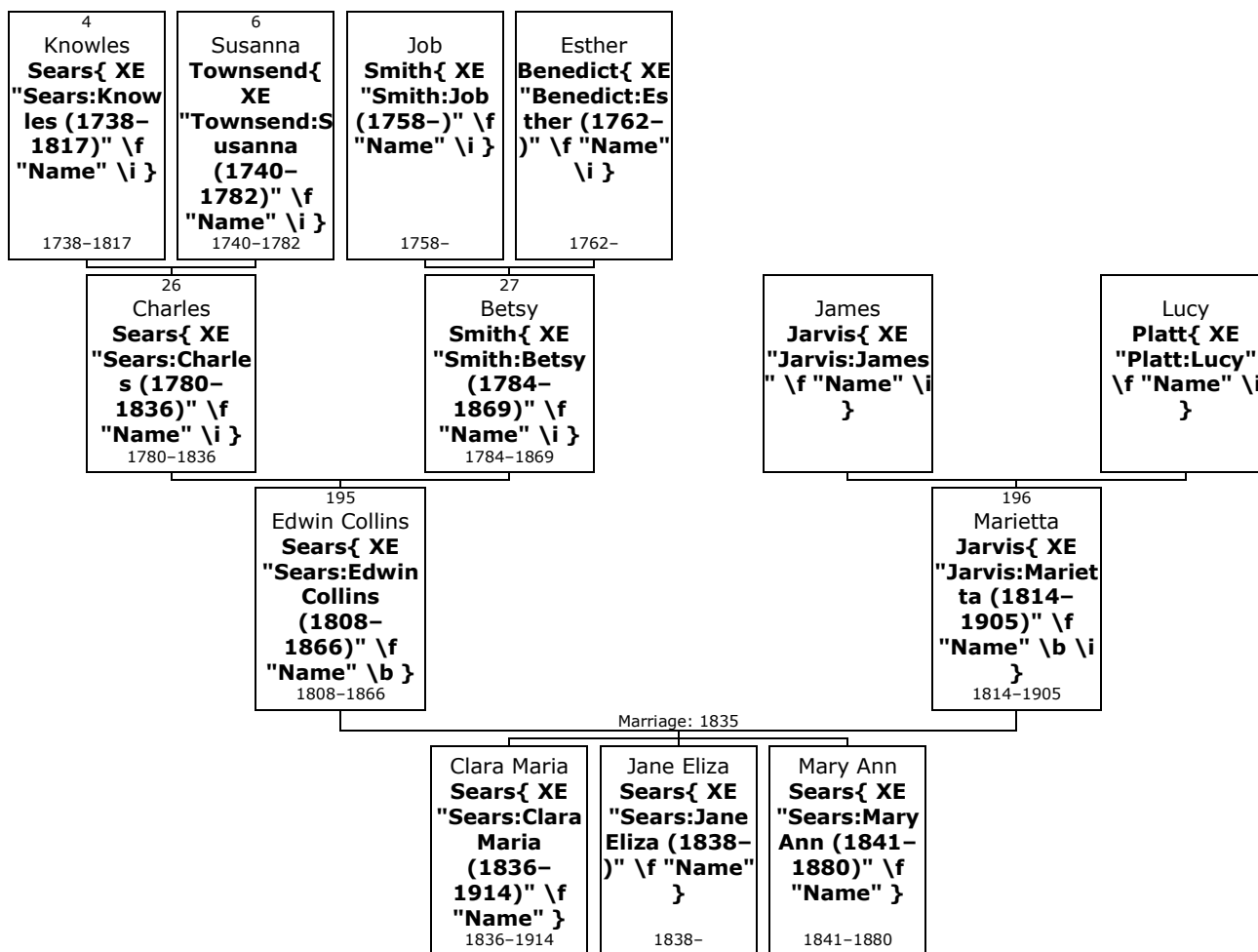

- 195. Edwin Collins⁵ Sears**{ XE "Sears:Edwin Collins (1808–1866)" \f "Name" \b } (*Charles⁴, Susanna³ Townsend*) was born on Sunday, 17th January 1808, in Ridgefield, Fairfield, Connecticut, USA{ XE "USA, Connecticut, Fairfield, Ridgefield:(41.2815° N, 73.4982° W):Sears, Edwin Collins (1808–1866)" \f "Place" }.^[382, 383] He was the son of Charles Sears{ XE "Sears:Charles (1780–1836)" \f "Name" \i } (26) and Betsy Smith{ XE "Smith:Betsy (1784–1869)" \f "Name" \i } (27).

Edwin Collins died in Danbury{ XE "USA, Connecticut, Fairfield, Danbury:(41.3948° N, 73.454° W):Sears, Edwin Collins (1808–1866)" \f "Place" } on 7th June 1866, at the age of 58.^[382, 383] He was buried. Wooster Cemetery.

!S.P. May No 1669 p.422 Edwin Sears was a hatter, lived for a time in Ridgefield, Reading and Sharon, and died in Danbury, CT, and was buried in Wooster Cemetery. His widow lives in Millplain, CT.

- 196.** Edwin Collins married **Marietta Jarvis**{ XE "Jarvis:Marietta (1814–1905)" \f "Name" \b \i } on Sunday, 22nd February 1835, in North Salem, Westchester, New York{ XE "USA, New York, Westchester, North

³⁸² Ancestry.com, Connecticut, Deaths and Burials Index, 1650-1934 (Provo, UT, USA, Ancestry.com Operations, Inc., 2011), Ancestry.com.

³⁸³ Ancestry.com, Connecticut, Hale Cemetery Inscriptions and Newspaper Notices, 1629-1934 (Provo, UT, USA, Ancestry.com Operations, Inc., 2012), Ancestry.com.
[Source citation includes one media item]

Salem:(41.3347° N, 73.5717° W):Sears, Edwin Collins (1808–1866)" \f "Place" }.^[382, 384] They had three daughters: Clara (1836–1914), Jane (1838–) and Mary (1841–1880).

Marietta was born in perh, North Salem, Salem, Washington,{ XE "USA, New York, Washington, Salem, North Salem, perh: :Jarvis, Marietta (1814–1905)" \f "Place" } in 1814.^[384] She was the daughter of James Jarvis{ XE "Jarvis:James" \f "Name" \i } and Lucy Platt{ XE "Platt:Lucy" \f "Name" \i }.

Marietta reached 91 years of age and died in Danbury{ XE "USA, Connecticut, Fairfield, Danbury:(41.3948° N, 73.454° W):Jarvis, Marietta (1814–1905)" \f "Place" } in 1905.^[382]

More facts and events for Marietta Jarvis:

Residence: 1850 Ridgefield{ XE "USA, Connecticut, Fairfield, Ridgefield:(41.2815° N, 73.4982° W):Jarvis, Marietta (1814–1905)" \f "Place" }^[384]

Daughters of Edwin Collins Sears and Marietta Jarvis:

- f I. **Clara Maria⁶ Sears**{ XE "Sears:Clara Maria (1836–1914)" \f "Name" \b } was born in Ridgefield, Fairfield, Connecticut,{ XE "USA, Connecticut, Fairfield, Ridgefield:(41.2815° N, 73.4982° W):Sears, Clara Maria (1836–1914)" \f "Place" } on 4th February 1836.^[382, 385, 386] She died in Connecticut{ XE "USA, Connecticut:(41.5735° N, 72.7383° W):Sears, Clara Maria (1836–1914)" \f "Place" } in 1914 at the age of 77.^[382, 386] Clara Maria was buried in Danbury, Fairfield, Connecticut{ XE "USA, Connecticut, Fairfield, Danbury:(41.3948° N, 73.454° W):Sears, Clara Maria (1836–1914)" \f "Place" }.^[386]

More facts and events for Clara Maria Sears:

Residence: 1900 Danbury{ XE "USA, Connecticut, Fairfield, Danbury:(41.3948° N, 73.454° W):Sears, Clara Maria (1836–1914)" \f "Place" }^[385]
Marital Status: Married; Relation to Head: Wife

Clara Maria married **John Canfield**{ XE "Canfield:John (1830–)" \f "Name" \b \i } on Wednesday, 22nd December 1852, in Ridgefield{ XE "USA, Connecticut, Fairfield, Ridgefield:(41.2815° N, 73.4982° W):Sears, Clara Maria (1836–1914)" \f "Place" }.^[385] They had five children: Edwin (1854–), Charles (1856–), Caroline (1861–), Wilfred (1863–) and John (1872–).

John was born in Connecticut{ XE "USA, Connecticut:(41.5735° N, 72.7383° W):Canfield, John (1830–)" \f "Place" } in 1830.^[385] He was the son of Rufus Canfield{ XE "Canfield:Rufus" \f "Name" \i } and Polly Northrop{ XE "Northrop:Polly" \f "Name" \i }.

- f II. **Jane Eliza Sears**{ XE "Sears:Jane Eliza (1838–)" \f "Name" \b } was born in Redding{ XE "USA, Connecticut, Fairfield, Redding:(41.3025° N, 73.3839° W):Sears, Jane Eliza (1838–)" \f "Place" } on 25th April 1838.^[387]

More facts and events for Jane Eliza Sears:

Residence: 1910 Cato{ XE "USA, Michigan, Montcalm, Cato:(43.4431° N, 85.2647° W):Sears, Jane Eliza (1838–)" \f "Place" }^[387]
Marital Status: Married; Relation to Head of House: Wife

³⁸⁴ Ancestry.com, 1850 United States Federal Census (Provo, UT, USA, Ancestry.com Operations, Inc., 2009), Ancestry.com, Year: 1850; Census Place: Ridgefield, Fairfield, Connecticut; Roll: M432_37; Page: 177B; Image: 357. [Source citation includes one media item]

³⁸⁵ Ancestry.com, 1900 United States Federal Census (Provo, UT, USA, Ancestry.com Operations Inc, 2004), Ancestry.com, Year: 1900; Census Place: Danbury, Fairfield, Connecticut; Roll: 132; Page: 16B; Enumeration District: 0051; FHL microfilm: 1240132.

³⁸⁶ Ancestry.com, U.S., Find A Grave Index, 1600s-Current (Provo, UT, USA, Ancestry.com Operations, Inc., 2012), Ancestry.com.

³⁸⁷ Ancestry.com, 1910 United States Federal Census (Provo, UT, USA, Ancestry.com Operations Inc, 2006), Ancestry.com, Year: 1910; Census Place: Cato, Montcalm, Michigan; Roll: T624_665; Page: 1A; Enumeration District: 0146; FHL microfilm: 1374678.

Jane Eliza Sears married **Charles E Butler**{ XE "Butler:Charles E (1834-)" \f "Name" \b \i }.^[387] They had no known children.

Charles E was born in perh, Redding, Fairfield, Connecticut,{ XE "USA, Connecticut, Fairfield, Redding, perh: :Butler, Charles E (1834-)" \f "Place" } in 1834.^[387]

f III. **Mary Ann Sears**{ XE "Sears:Mary Ann (1841-1880)" \f "Name" \b } was born in Sharon, Litchfield,{ XE "USA, Connecticut, Litchfield, Sharon:(41.8792° N, 73.4772° W):Sears, Mary Ann (1841-1880)" \f "Place" } on 15th January 1841.^[386] She died in New Milford{ XE "USA, Connecticut, Litchfield, New Milford:(41.577° N, 73.4084° W):Sears, Mary Ann (1841-1880)" \f "Place" } in 1880 at the age of 38.^[386] Mary Ann was buried in Danbury, Fairfield{ XE "USA, Connecticut, Fairfield, Danbury:(41.3948° N, 73.454° W):Sears, Mary Ann (1841-1880)" \f "Place" }.^[386]



Mary

Mary Ann Sears married **Adoniram S Blackman**{ XE "Blackman:Adoniram S (1837-1879)" \f "Name" \b \i } in September 1859.^[386] They had no known children.

Adoniram S was born in Danbury{ XE "USA, Connecticut, Fairfield, Danbury:(41.3948° N, 73.454° W):Blackman, Adoniram S (1837-1879)" \f "Place" } in 1837.^[386] He reached 42 years of age and died in 1879.^[386] Adoniram S was buried in Danbury{ XE "USA, Connecticut, Fairfield, Danbury:(41.3948° N, 73.454° W):Blackman, Adoniram S (1837-1879)" \f "Place" }.^[386]

Family of George Sears and Sarah Gregory{ TC "George Sears and Sarah Gregory" \I 3 \f C}

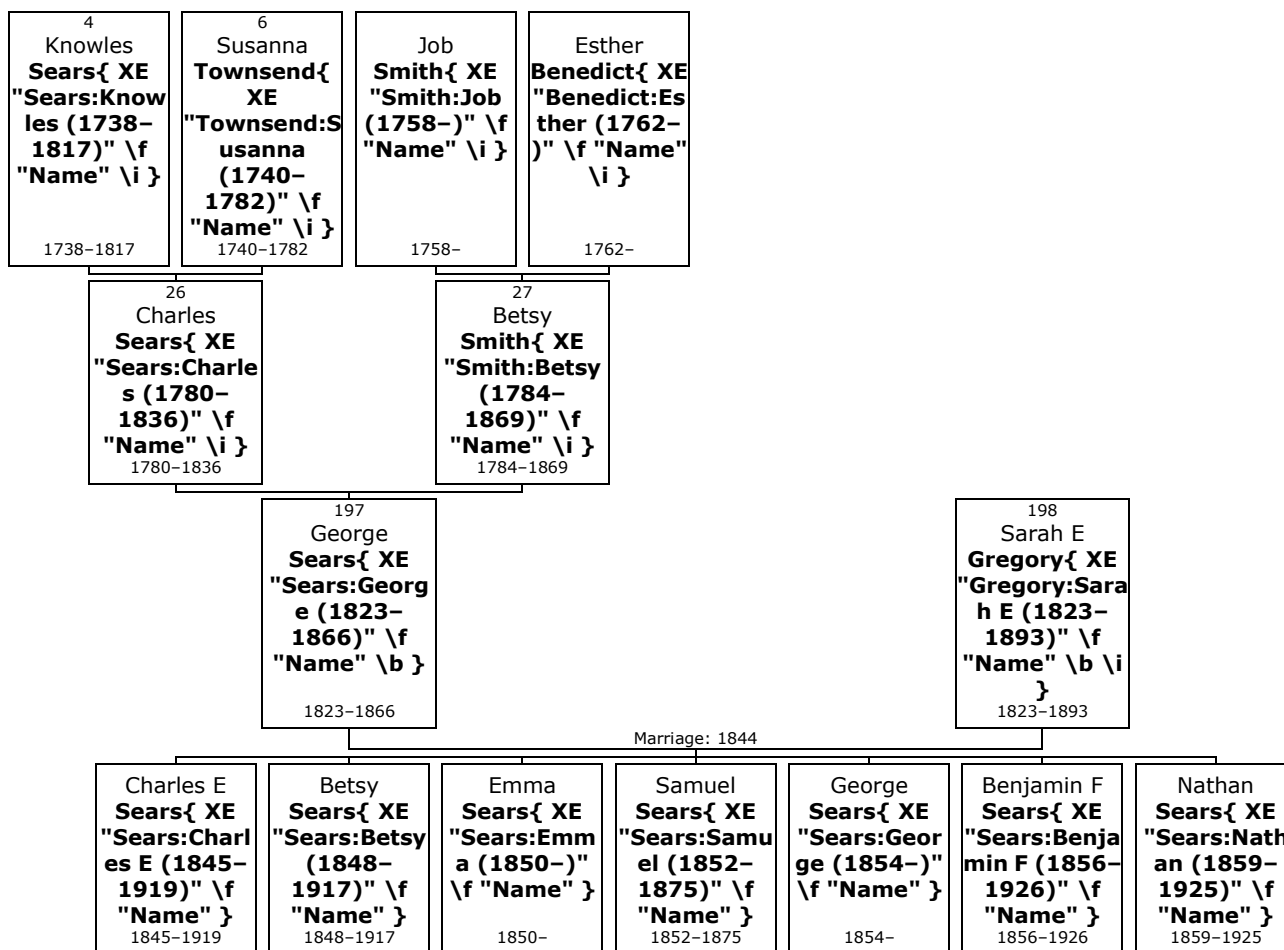

197. Corp George⁵ Sears{ XE "Sears:George (1823-1866)" \f "Name" \b } (*Charles⁴, Susanna³ Townsend*) was born on Wednesday, 12th March 1823, in Camillus, Onondaga, New York, USA{ XE "USA, New York,

Onondaga, Camillus:(43.0392° N, 76.3041° W):Sears, George (1823–1866)" \f "Place" }.^[388, 389–390] He was the son of Charles Sears{ XE "Sears:Charles (1780–1836)" \f "Name" \i } (26) and Betsy Smith{ XE "Smith:Betsy (1784–1869)" \f "Name" \i } (27).

George died in Danbury{ XE "USA, Connecticut, Fairfield, Danbury:(41.3948° N, 73.454° W):Sears, George (1823–1866)" \f "Place" } on 8th November 1866, at the age of 43.^[388, 389] He was buried.^[389] Wooster Cemetery.

!S.P. May No 1670 p.423 George Sears was a hatter, died in Danbury, CT, and was buried in Wooster Cemetery.

<https://www.wikitree.com/wiki/Sears-5716>

!

!Connecticut, Deaths and Burials Index, 1650-1934 about George Sears Name: George Sears Birth Date: abt 1823 Age at Death: 43 Death Date: 8 Nov 1866 Death Place: Danbury, Connecticut Gender: Male FHL Film Number: 3328

!

!1850 United States Federal Census about George Sears Name: George Sears Age: 27 Birth Year: abt 1823 Birthplace: New York Home in 1850: Ridgefield, Fairfield, Connecticut Gender: Male Family Number: 464 Household Members: Name Age George Sears 27 Sarah Sears 22 Charles E Sears 4 Betsey Sears 2 Emma Sears 0 Betsey Sears 65

!

!Find A Grave Memorial# 79474052

Web: Connecticut, Find A Grave Index, 1636-2011 about Corp George Sears Name: Corp George Sears Death Date: 8 Nov 1866 Burial Place: Danbury, Fairfield County, Connecticut, USA Birth: Mar. 12, 1823 Camillus Onondaga County New York, USA Death: Nov. 8, 1866 Danbury Fairfield County Connecticut, USA Married Sarah Gregory - 1844 (7 children) - Ridgefield, CT Moved to Danbury in early 1850s Profession: Hatter Civil War Service: - Connecticut Volunteers 1st Regiment Infantry (Three months' men), Company E, Apr to July 1861 (Private). Served at the First Battle of Bull Run (Manassas). Including George Sears, 3 members of Company E would go on to serve in the CT 17th Infantry. - Connecticut Volunteers 17th Regiment Infantry, Company C, Aug 1862 to June 1865. Promoted to corporal Jan '63. Captured at Gettysburg, 1 July 1863, during the 11 Corps retreat from Barlow's Knoll. Imprisoned at Belle Island, Richmond. Paroled 25 Aug '86, returned to the CT 17th in SC. Remained with Co. C 17th CT in SC and FL until discharged due to illness in June 1865. Died in 1866 due to illness believed to have been acquired during his imprisonment on Belle Island (likely tuberculosis). Family links: Parents: Charles Sears (1780 - 1836) Betsy Smith Sears (1784 - 1869) Children: Nathan Sears (1858 - 1925) Inscription: Corp. GEORGE SEARS Co. C. 17 Inf. Conn. Vols. Died Nov. 8, 1866. AE. 43. Burial: Wooster Cemetery Danbury Fairfield County Connecticut, USAGPS (lat/lon): 41.40437, -73.45384 Maintained by: Eric Goodson Originally Created by: Bob R Record added: Oct 28, 2011

More facts and events for George Sears:

Residence: 1850 Ridgefield{ XE "USA, Connecticut, Fairfield, Ridgefield:(41.2815° N, 73.4982° W):Sears, George (1823–1866)" \f "Place" }^[390]

- 198.** George married **Sarah E Gregory**{ XE "Gregory:Sarah E (1823–1893)" \f "Name" \b \i } in 1844 in Ridgefield{ XE "USA, Connecticut, Fairfield, Ridgefield:(41.2815° N, 73.4982° W):Sears, George (1823–1866)" \f "Place" }. They had seven children: Charles (1845–1919), Betsy (1848–1917), Emma (1850–), Samuel (1852–1875), George (1854–), Benjamin (1856–1926) and Nathan (1859–1925).

Sarah E was born in perh, Ridgefield,{ XE "USA, Connecticut, Fairfield, Ridgefield, perh: :Gregory, Sarah E (1823–1893)" \f "Place" } in 1823. She reached 70 years of age and died in 1893.

³⁸⁸ Ancestry.com, Connecticut, Deaths and Burials Index, 1650-1934 (Provo, UT, USA, Ancestry.com Operations, Inc., 2011), Ancestry.com.

³⁸⁹ Ancestry.com, U.S., Find A Grave Index, 1600s-Current (Provo, UT, USA, Ancestry.com Operations, Inc., 2012), Ancestry.com.

³⁹⁰ Ancestry.com, 1850 United States Federal Census (Provo, UT, USA, Ancestry.com Operations, Inc., 2009), Ancestry.com, Year: 1850; Census Place: Ridgefield, Fairfield, Connecticut; Roll: M432_37; Page: 180B; Image: 363. [Source citation includes one media item]

Children of George Sears and Sarah E Gregory:

m I. **Charles E^o Sears**{ XE "Sears:Charles E (1845–1919)" \f "Name" \b } was born in Ridgefield, Fairfield County,{ XE "USA, Connecticut, Fairfield County, Ridgefield:(41.2815° N, 73.4982° W):Sears, Charles E (1845–1919)" \f "Place" } on 2nd September 1845.^[390, 391, 392–393] He died in 1919 at the age of 73.

More facts and events for Charles E Sears:

- Residence: 1850 Ridgefield, Fairfield, Connecticut{ XE "USA, Connecticut, Fairfield, Ridgefield:(41.2815° N, 73.4982° W):Sears, Charles E (1845–1919)" \f "Place" }
- Residence: 1850 Ridgefield{ XE "USA, Connecticut, Fairfield, Ridgefield:(41.2815° N, 73.4982° W):Sears, Charles E (1845–1919)" \f "Place" }^[390]
- Residence: 1860 Danbury{ XE "USA, Connecticut, Fairfield, Danbury:(41.3948° N, 73.454° W):Sears, Charles E (1845–1919)" \f "Place" }
- Residence: 1870 Danbury{ XE "USA, Connecticut, Fairfield, Danbury:(41.3948° N, 73.454° W):Sears, Charles E (1845–1919)" \f "Place" }
- Residence: 1880 Danbury{ XE "USA, Connecticut, Fairfield, Danbury:(41.3948° N, 73.454° W):Sears, Charles E (1845–1919)" \f "Place" }
- Residence: 1880 Danbury{ XE "USA, Connecticut, Fairfield, Danbury:(41.3948° N, 73.454° W):Sears, Charles E (1845–1919)" \f "Place" }^[392]
Marital status: Single; Relation to Head of House: Brother
- Residence: 1900 Bethel{ XE "USA, Connecticut, Fairfield, Bethel:(41.3729° N, 73.4114° W):Sears, Charles E (1845–1919)" \f "Place" }
- Residence: 1900 Bethel{ XE "USA, Connecticut, Fairfield, Bethel:(41.3729° N, 73.4114° W):Sears, Charles E (1845–1919)" \f "Place" }^[391]
Marital Status: Widowed; Relation to Head: Father in Law
- Residence: 1910 Ward 1, Orange, Essex, New Jersey{ XE "USA, New Jersey, Essex, Orange, Ward 1: :Sears, Charles E (1845–1919)" \f "Place" }^[393]
Marital Status: Married; Relation to Head of House: Head
- Residence: 1910 Ward 1{ XE "USA, New Jersey, Essex, Orange, Ward 1: :Sears, Charles E (1845–1919)" \f "Place" }
- Residence: 1920 Ward 3, West Orange{ XE "USA, New Jersey, Essex, West Orange, Ward 3: :Sears, Charles E (1845–1919)" \f "Place" }

³⁹¹ Ancestry.com, 1900 United States Federal Census (Provo, UT, USA, Ancestry.com Operations Inc, 2004), Ancestry.com, Year: 1900; Census Place: Bethel, Fairfield, Connecticut; Roll: 131; Page: 5A; Enumeration District: 0001; FHL microfilm: 1240131.

³⁹² Ancestry.com and The Church of Jesus Christ of Latter-day Saints, 1880 United States Federal Census (Provo, UT, USA, Ancestry.com Operations Inc, 2010), Ancestry.com, Year: 1880; Census Place: Danbury, Fairfield, Connecticut; Roll: 94; Family History Film: 1254094; Page: 139B; Enumeration District: 113; Image: 0281.

³⁹³ Ancestry.com, 1910 United States Federal Census (Provo, UT, USA, Ancestry.com Operations Inc, 2006), Ancestry.com, Year: 1910; Census Place: Orange Ward 1, Essex, New Jersey; Roll: T624_884; Page: 1A; Enumeration District: 0205; FHL microfilm: 1374897.

Charles E married **Isabella --Sears**{ XE "--Sears:Isabella (1870-)" \f "Name" \b \i }.^[393, 394] They had no known children.

Isabella was born in Isle of Bale, Scotland,{ XE "Scotland, Isle of Bale: :--Sears, Isabella (1870-)" \f "Place" } on Tuesday, 16th August 1870.^[393, 394]

Charles E Sears married **Mary F Taylor**{ XE "Taylor:Mary F (1844-1880)" \f "Name" \b \i }. They had one daughter: Lillie (1867-1901).

Mary F was born in Connecticut{ XE "USA, Connecticut:(41.5735° N, 72.7383° W):Taylor, Mary F (1844-1880)" \f "Place" } in 1844. She reached 36 years of age and died in 1880.

- f II. **Betsy Sears**{ XE "Sears:Betsy (1848-1917)" \f "Name" \b } was born in Connecticut{ XE "USA, Connecticut:(41.5735° N, 72.7383° W):Sears, Betsy (1848-1917)" \f "Place" } in 1848.^[390, 395] She died in 1917 at the age of 69.

More facts and events for Betsy Sears:

Residence: 1850 Ridgefield{ XE "USA, Connecticut, Fairfield, Ridgefield:(41.2815° N, 73.4982° W):Sears, Betsy (1848-1917)" \f "Place" }^[390]

Residence: 1860 Danbury{ XE "USA, Connecticut, Fairfield, Danbury:(41.3948° N, 73.454° W):Sears, Betsy (1848-1917)" \f "Place" }^[395]

- f III. **Emma Sears**{ XE "Sears:Emma (1850-)" \f "Name" \b } was born in Connecticut{ XE "USA, Connecticut:(41.5735° N, 72.7383° W):Sears, Emma (1850-)" \f "Place" } in 1850.^[395]

More facts and events for Emma Sears:

Residence: 1860 Danbury{ XE "USA, Connecticut, Fairfield, Danbury:(41.3948° N, 73.454° W):Sears, Emma (1850-)" \f "Place" }^[395]

- m IV. **Samuel Sears**{ XE "Sears:Samuel (1852-1875)" \f "Name" \b } was born in Connecticut{ XE "USA, Connecticut:(41.5735° N, 72.7383° W):Sears, Samuel (1852-1875)" \f "Place" } in 1852.^[395, 396] He died in Bridgeport{ XE "USA, Connecticut, Fairfield, Bridgeport:(41.167° N, 73.2048° W):Sears, Samuel (1852-1875)" \f "Place" } on 27th October 1875, at the age of 23.^[396]

More facts and events for Samuel Sears:

Residence: 1860 Danbury{ XE "USA, Connecticut, Fairfield, Danbury:(41.3948° N, 73.454° W):Sears, Samuel (1852-1875)" \f "Place" }^[395]

- m V. **George Sears**{ XE "Sears:George (1854-)" \f "Name" \b } was born in New York{ XE "USA, New York:(42.7531° N, 74.2224° W):Sears, George (1854-)" \f "Place" } in 1854.^[395, 397]

³⁹⁴ Ancestry.com, U.S. Passport Applications, 1795-1925 (Provo, UT, USA, Ancestry.com Operations, Inc., 2007), Ancestry.com, National Archives and Records Administration (NARA); Washington D.C.; NARA Series: Passport Applications, January 2, 1906 - March 31, 1925; Roll #: 1886; Volume #: Roll 1886 - Certificates: 138600-138975, 04 Apr 1922-04 Apr 1922. [Source citation includes one media item]

³⁹⁵ Ancestry.com, 1860 United States Federal Census (Provo, UT, USA, Ancestry.com Operations, Inc., 2009), Ancestry.com, Year: 1860; Census Place: Danbury, Fairfield, Connecticut; Roll: M653_73; Page: 189; Family History Library Film: 803073.

³⁹⁶ Ancestry.com, Connecticut, Hale Cemetery Inscriptions and Newspaper Notices, 1629-1934 (Provo, UT, USA, Ancestry.com Operations, Inc., 2012), Ancestry.com.

³⁹⁷ Ancestry.com, 1870 United States Federal Census (Provo, UT, USA, Ancestry.com Operations, Inc., 2009), Ancestry.com, Year: 1870; Census Place: Danbury, Fairfield, Connecticut; Roll: M593_97; Page: 374B; Image: 209713; Family History Library Film: 545596.

More facts and events for George Sears:

Residence: 1860 Danbury{ XE "USA, Connecticut, Fairfield, Danbury:(41.3948° N, 73.454° W):Sears, George (1854-)" \f "Place" }^[395]

Residence: 1870 Danbury{ XE "USA, Connecticut, Fairfield, Danbury:(41.3948° N, 73.454° W):Sears, George (1854-)" \f "Place" }^[397]

Post Office: Danbury

m VI. **Benjamin F Sears**{ XE "Sears:Benjamin F (1856-1926)" \f "Name" \b } was born in Westport, Fairfield, Connecticut,{ XE "USA, Connecticut, Fairfield, Westport:(41.1415° N, 73.3579° W):Sears, Benjamin F (1856-1926)" \f "Place" } on 4th March 1856.^[392, 398, 399-400] He died in Danbury{ XE "USA, Connecticut, Fairfield, Danbury:(41.3948° N, 73.454° W):Sears, Benjamin F (1856-1926)" \f "Place" } on 1st March 1926, at the age of 69.



Benjamin

More facts and events for Benjamin F Sears:

Residence: 1880 Danbury{ XE "USA, Connecticut, Fairfield, Danbury:(41.3948° N, 73.454° W):Sears, Benjamin F (1856-1926)" \f "Place" }^[392]
Marital status: Married; Relation to Head of House: Self

Residence: 1900 Danbury{ XE "USA, Connecticut, Fairfield, Danbury:(41.3948° N, 73.454° W):Sears, Benjamin F (1856-1926)" \f "Place" }^[399]
Marital Status: Married; Relation to Head: Head

Residence: 1910 Ward 2, Danbury{ XE "USA, Connecticut, Fairfield, Danbury, Ward 2: :Sears, Benjamin F (1856-1926)" \f "Place" }^[398]
Marital Status: Widowed; Relation to Head of House: Head

Benjamin F Sears married **Mary A Bolger**{ XE "Bolger:Mary A (1858-1908)" \f "Name" \b \i } in 1878.^[392, 399, 400] They had six children: Mary (1878-), Benjamin (1882-1938), Effie (1884-1945), Charles (1888-), Robert (1890-1926) and Irene (1895-1974).

Mary A was born in Yonkers, Westchester, New York,{ XE "USA, New York, Westchester, Yonkers:(40.9312° N, 73.8987° W):Bolger, Mary A (1858-1908)" \f "Place" } on Sunday, 13th June 1858.^[392, 399] She reached 50 years of age and died in Danbury{ XE "USA, Connecticut, Fairfield, Danbury:(41.3948° N, 73.454° W):Bolger, Mary A (1858-1908)" \f "Place" } on 11th October 1908.

³⁹⁸ Ancestry.com, 1910 United States Federal Census (Provo, UT, USA, Ancestry.com Operations Inc, 2006), Ancestry.com, Year: 1910; Census Place: Danbury Ward 2, Fairfield, Connecticut; Roll: T624_129; Page: 1B; Enumeration District: 0609; FHL microfilm: 1374142.

³⁹⁹ Ancestry.com, 1900 United States Federal Census (Provo, UT, USA, Ancestry.com Operations Inc, 2004), Ancestry.com, Year: 1900; Census Place: Danbury, Fairfield, Connecticut; Roll: 132; Page: 4B; Enumeration District: 0058; FHL microfilm: 1240132.

⁴⁰⁰ Ancestry.com, U.S., Social Security Applications and Claims Index, 1936-2007 (Provo, UT, USA, Ancestry.com Operations, Inc., 2015), Ancestry.com.

m VII. **Nathan Sears**{ XE "Sears:Nathan (1859–1925)" \f "Name" \b } was born in Connecticut{ XE "USA, Connecticut:(41.5735° N, 72.7383° W):Sears, Nathan (1859–1925)" \f "Place" } in 1859.^[389, 392, 401, 402–403] He died on 13th August 1925, at the age of 66.^[389, 403] Nathan was buried in Los Angeles, Los Angeles County{ XE "USA, California, Los Angeles County, Los Angeles:(34.0522° N, 118.2437° W):Sears, Nathan (1859–1925)" \f "Place" }.^[389, 403]



Nathan

More facts and events for Nathan Sears:

Residence: 1880 Danbury, Fairfield, Connecticut{ XE "USA, Connecticut, Fairfield, Danbury:(41.3948° N, 73.454° W):Sears, Nathan (1859–1925)" \f "Place" }.^[392]
 Marital status: Single; Relation to Head of House: Brother

Residence: 1910 Assembly District 74, Los Angeles, Los Angeles, California{ XE "USA, California, Los Angeles, Los Angeles, Assembly District 74: :Sears, Nathan (1859–1925)" \f "Place" }.^[401]
 Marital Status: Single; Relation to Head of House: Lodger

Residence: 1920 Assembly District 74{ XE "USA, California, Los Angeles, Los Angeles, Assembly District 74: :Sears, Nathan (1859–1925)" \f "Place" }.^[402]
 Marital Status: Single; Relation to Head of House: Lodger

Nathan Sears married **Catherine McGough**{ XE "McGough:Catherine (1859–1908)" \f "Name" \b \i }.^[389] They had one son: George (1877–1945).

Catherine was born in Bridgeport, Fairfield, Connecticut,{ XE "USA, Connecticut, Fairfield, Bridgeport:(41.167° N, 73.2048° W):McGough, Catherine (1859–1908)" \f "Place" } in September 1859.^[389] She reached 48 years of age and died in Bridgeport{ XE "USA, Connecticut, Fairfield, Bridgeport:(41.167° N, 73.2048° W):McGough, Catherine (1859–1908)" \f "Place" } on 23rd May 1908.^[389] Catherine was buried in Stratford{ XE "USA, Connecticut, Fairfield, Stratford:(41.1845° N, 73.1332° W):McGough, Catherine (1859–1908)" \f "Place" }.^[389]

⁴⁰¹ Ancestry.com, 1910 United States Federal Census (Provo, UT, USA, Ancestry.com Operations Inc, 2006), Ancestry.com, Year: 1910; Census Place: Los Angeles Assembly District 74, Los Angeles, California; Roll: T624_83; Page: 13A; Enumeration District: 0065; FHL microfilm: 1374096.

⁴⁰² Ancestry.com, 1920 United States Federal Census (Provo, UT, USA, Ancestry.com Operations Inc, 2010), Ancestry.com, Year: 1920; Census Place: Los Angeles Assembly District 74, Los Angeles, California; Roll: T625_115; Page: 11B; Enumeration District: 435; Image: 334.

⁴⁰³ Ancestry.com, U.S., Burial Registers, Military Posts and National Cemeteries, 1862-1960 (Provo, UT, USA, Ancestry.com Operations, Inc., 2012), Ancestry.com.

Family of Ruth Crosby and Roderick Price{ TC "Ruth Crosby and Roderick Price" \I 3 \f C}

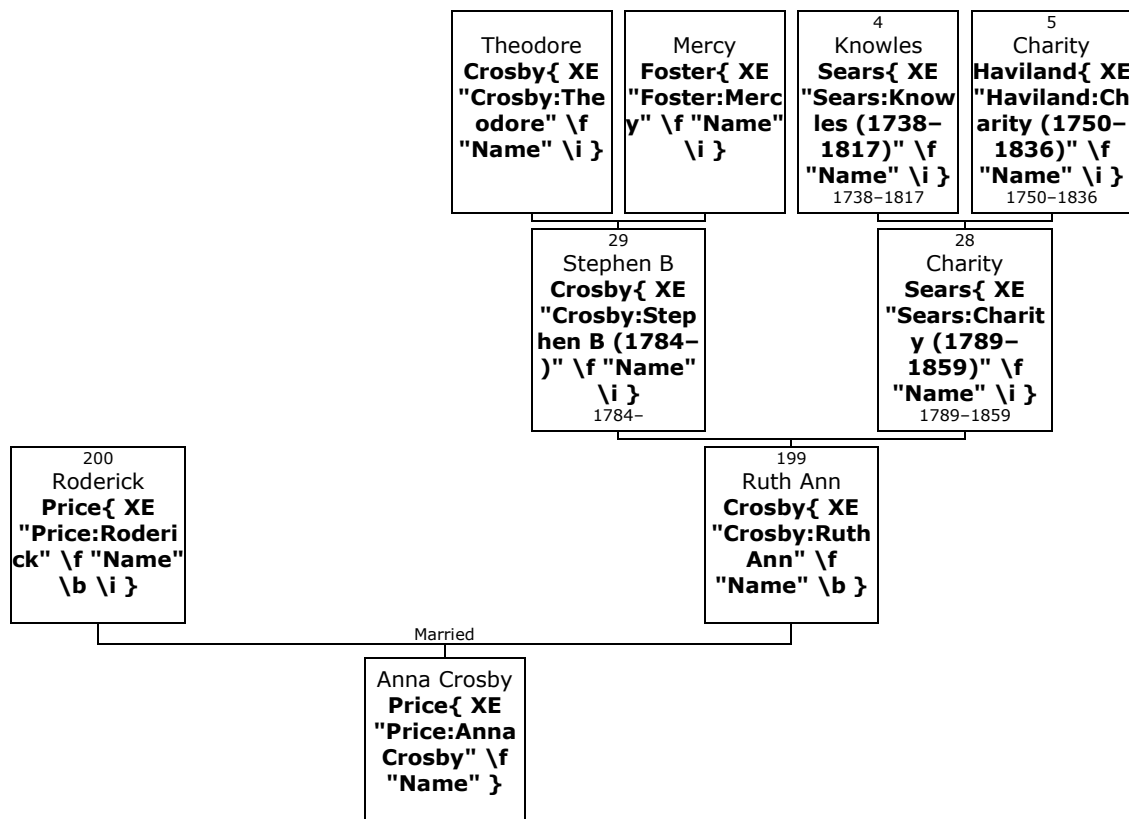

199. Ruth Ann⁵ Crosby{ XE "Crosby:Ruth Ann" \f "Name" \b } (*Charity⁴ Sears, Capt Knowles³, James²*). She is the daughter of Stephen B Crosby{ XE "Crosby:Stephen B (1784-)" \f "Name" \i } (29) and Charity Sears{ XE "Sears:Charity (1789-1859)" \f "Name" \i } (28).

200. She married **Roderick Price**{ XE "Price:Roderick" \f "Name" \b \i }. They had one daughter: Anna.

Daughter of Ruth Ann Crosby and Roderick Price:

- f I. **Anna Crosby⁶ Price**{ XE "Price:Anna Crosby" \f "Name" \b } was born in New York, USA{ XE "USA, New York:(42.7531° N, 74.2224° W):Price, Anna Crosby" \f "Place" \b }.^[404]

More facts and events for Anna Crosby Price:

Residence: 1900 Ward 24{ XE "USA, New York, Erie, Buffalo, Ward 24:Price, Anna Crosby" \f "Place" \b }.^[404]
 StreetAddress: Delaware Avenue; Age: 60;
 AbleToSpeakEnglish: Yes; CanRead: Yes; CanWrite: Yes;
 EnumerationDistrict: 0200; NumberOfChildrenBorn: 3;
 NumberOfChildrenLiving: 3; YearsMarried: 38;
 MaritalStatus: Married; RelationToHead: Wife

Anna Crosby married **Charles Munson Underhill**{ XE "Underhill:Charles Munson" \f "Name" \b \i } in 1862.^[404] They had three children: Irving (1866-), Augustus (1868-) and Bertha.

Charles Munson was born in New York{ XE "USA, New York:(42.7531° N, 74.2224° W):Underhill, Charles Munson" \f "Place" \b }.^[404]

⁴⁰⁴ Ancestry.com, 1900 United States Federal Census (Provo, UT, USA, Ancestry.com Operations Inc, 2004), Ancestry.com, Year: 1900; Census Place: Buffalo Ward 24, Erie, New York; Page: 5; Enumeration District: 0200; FHL microfilm: 1241031. Record for Anna P Underhill. <http://search.ancestry.com/cgi-bin/sse.dll?db=7602&h=32981687&indiv=try>.

Capt Byron Crosby married **Caroline Scott Walbridge**{ XE "Walbridge:Caroline Scott (1835-1909)" \f "Name" \b \i }.^[405-407] They had one daughter: Alice (1855-1950).

Caroline Scott was born in Bennington, Vermont,{ XE "USA, Vermont, Bennington:(43.0293° N, 73.1084° W):Walbridge, Caroline Scott (1835-1909)" \f "Place" } on Monday, 12th October 1835.^[406, 407] She reached 73 years of age and died in Winhall, Bennington,{ XE "USA, Vermont, Bennington, Winhall:(43.1692° N, 72.9223° W):Walbridge, Caroline Scott (1835-1909)" \f "Place" } in January 1909.^[406] Caroline Scott was buried in Bennington{ XE "USA, Vermont, Bennington, Bennington:(42.8781° N, 73.1968° W):Walbridge, Caroline Scott (1835-1909)" \f "Place" }.^[406]

Family of Charity Brush and Drum{ TC "Charity Brush and Drum" \I 3 \f C}

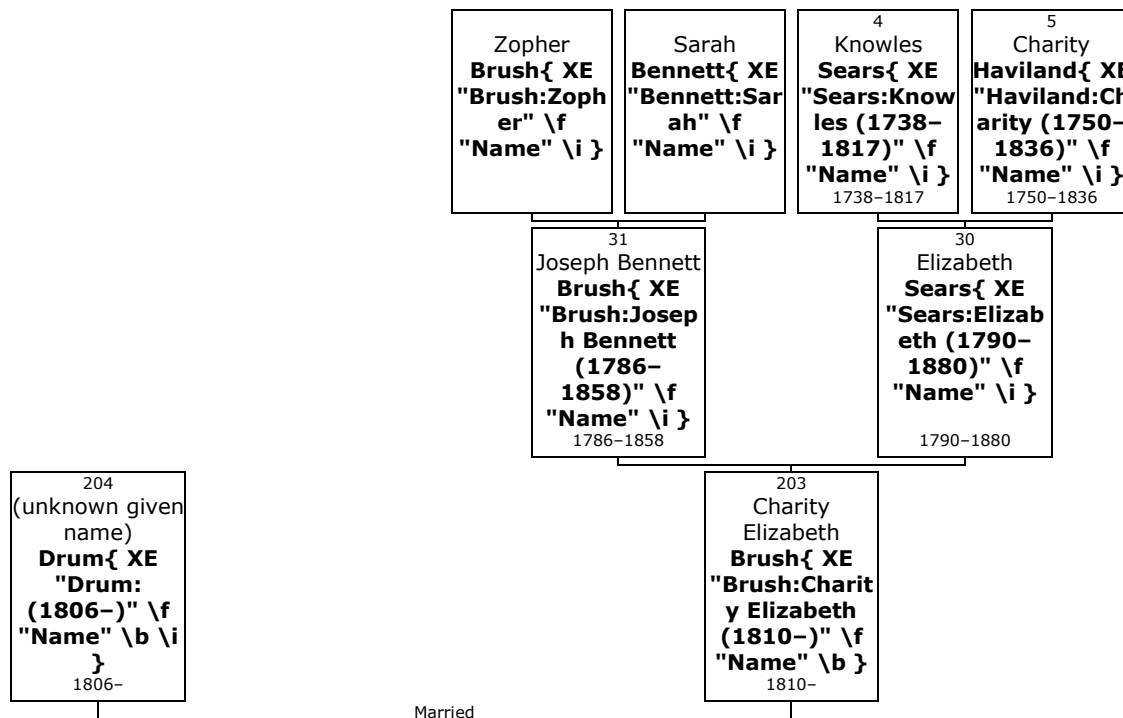

203. Charity Elizabeth⁵ Brush{ XE "Brush:Charity Elizabeth (1810-)" \f "Name" \b } (*Elizabeth⁴ Sears, Capt Knowles³, James²*) was born in 1810. She was the daughter of Joseph Bennett Brush{ XE "Brush:Joseph Bennett (1786-1858)" \f "Name" \i } (31) and Elizabeth Sears{ XE "Sears:Elizabeth (1790-1880)" \f "Name" \i } (30).

204. Charity Elizabeth married **(unknown given name) Drum**{ XE "Drum: (1806-)" \f "Name" \b \i }. 2d Marriage. They had no known children. (unknown given name) was born in 1806.

Family of Knowles Brush and Elizabeth Meeker{ TC "Knowles Brush and Elizabeth Meeker" \I 3 \f C}

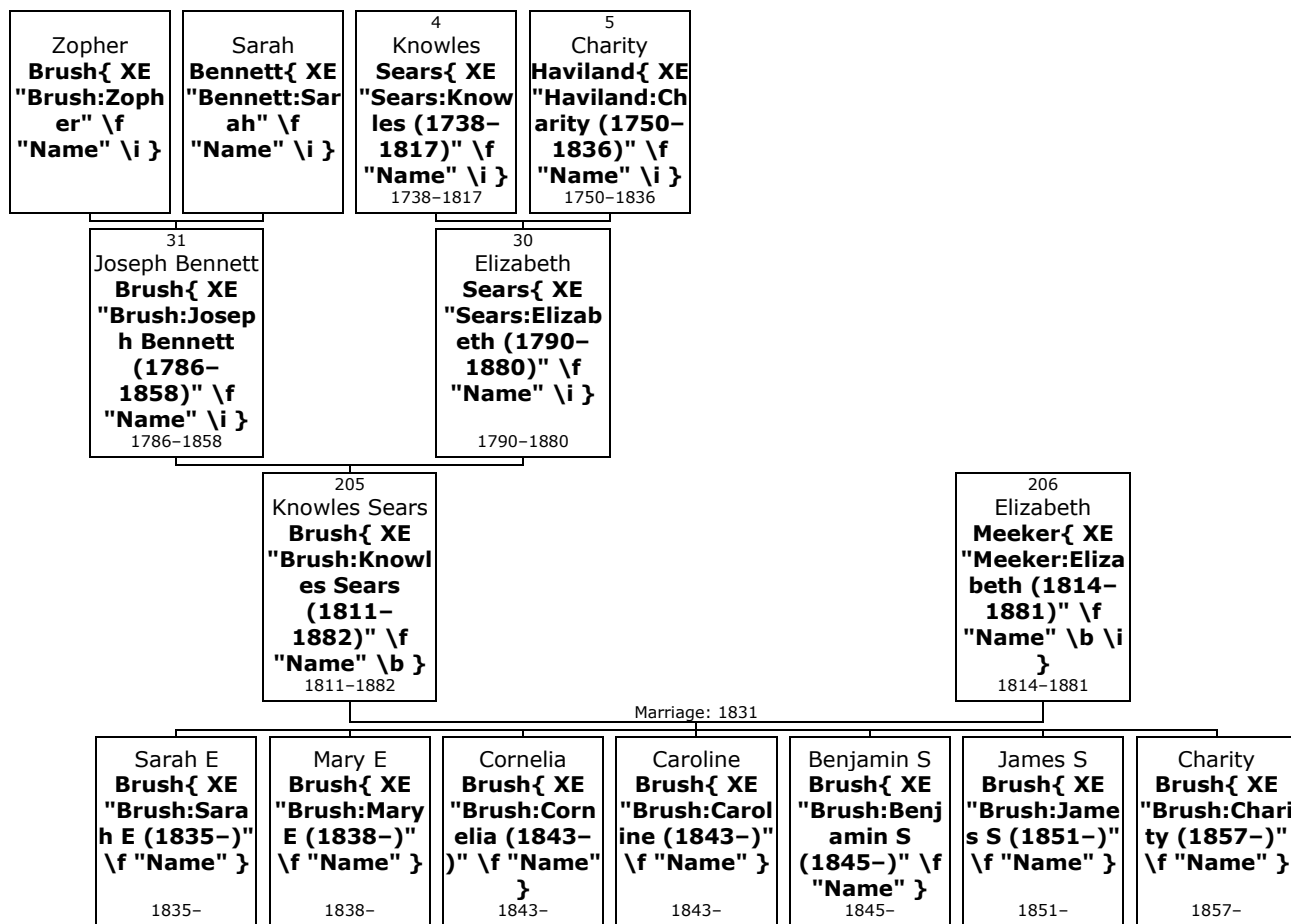

205. Knowles Sears⁵ Brush{ XE "Brush:Knowles Sears (1811-1882)" \f "Name" \b } (*Elizabeth⁴ Sears, Capt Knowles³, James²*) was born on Sunday, 11th August 1811.^[408] Ridgeberry, CT. He was the son of Joseph Bennett Brush{ XE "Brush:Joseph Bennett (1786-1858)" \f "Name" \i } (31) and Elizabeth Sears{ XE "Sears:Elizabeth (1790-1880)" \f "Name" \i } (30).

Knowles Sears died on 15th March 1882, at the age of 70. Son James' Residence.

!Census and marriage records call him Sears

206. At the age of 19, Knowles Sears married **Elizabeth Meeker**{ XE "Meeker:Elizabeth (1814-1881)" \f "Name" \b \i } on Wednesday, 16th February 1831, in Phelps, Ontario, New York, USA,{ XE "USA, New York, Ontario, Phelps:(42.9576° N, 77.0575° W):Brush, Knowles Sears (1811-1882)" \f "Place" } when she was 16 years old.^[408] They had seven children: Sarah (1835-), Mary (1838-), Cornelia (1843-), Caroline (1843-), Benjamin (1845-), James (1851-) and Charity (1857-).

Elizabeth was born in Phelps{ XE "USA, New York, Ontario, Phelps:(42.9576° N, 77.0575° W):Meeker, Elizabeth (1814-1881)" \f "Place" } on Saturday, 5th March 1814. She reached 67 years of age and died on 24th August 1881.

Children of Knowles Sears Brush and Elizabeth Meeker:

- f I. **Sarah E⁶ Brush**{ XE "Brush:Sarah E (1835-)" \f "Name" \b } was born in perh, Phelps,{ XE "USA, New York, Ontario, Phelps, perh: :Brush, Sarah E (1835-)" \f "Place" } in 1835.
- f II. **Mary E Brush**{ XE "Brush:Mary E (1838-)" \f "Name" \b } was born in perh{ XE "USA, New York, Ontario, Phelps, perh: :Brush, Mary E (1838-)" \f "Place" } in 1838.

⁴⁰⁸ Ancestry.com, New York 10,000 Vital Records of Central New York, 1813-1850 (Lehi, UT, USA, Ancestry.com Operations Inc, 2018), Ancestry.com, Genealogical Publishing Co.; Baltimore, Maryland; 10,000 Vital Records of Central New York, 1813-1850. Record for Sears Brush. <http://search.ancestry.com/cgi-bin/sse.dll?db=61696&h=1217&indiv=try>. [Source citation includes one media item]

- f III. **Cornelia Brush**{ XE "Brush:Cornelia (1843-)" \f "Name" \b } was born in perh{ XE "USA, New York, Ontario, Phelps, perh: :Brush, Cornelia (1843-)" \f "Place" } in 1843.
- f IV. **Caroline Brush**{ XE "Brush:Caroline (1843-)" \f "Name" \b } was born in perh{ XE "USA, New York, Ontario, Phelps, perh: :Brush, Caroline (1843-)" \f "Place" } in 1843.
- m V. **Benjamin S Brush**{ XE "Brush:Benjamin S (1845-)" \f "Name" \b } was born in perh{ XE "USA, New York, Ontario, Phelps, perh: :Brush, Benjamin S (1845-)" \f "Place" } in 1845.
- m VI. **James S Brush**{ XE "Brush:James S (1851-)" \f "Name" \b } was born in perh{ XE "USA, New York, Ontario, Phelps, perh: :Brush, James S (1851-)" \f "Place" } on 15th February 1851.^[409]

More facts and events for James S Brush:

Residence: 1880 Huron{ XE "USA, New York, Wayne, Huron:(43.2333° N, 76.8803° W):Brush, James S (1851-)" \f "Place" }^[409]
Age: 29; Occupation: Farmer; EnumerationDistrict: 177;
MaritalStatus: Married; RelationToHead: Self

James S married **Adeline E McQueen**{ XE "McQueen:Adeline E" \f "Name" \b \i }.^[409]
They had two sons: Knowles (1871-) and Henry (1878-).

Adeline E was born in New York{ XE "USA, New York:(42.7531° N, 74.2224° W):McQueen, Adeline E" \f "Place" }.^[409]

- f VII. **Charity Brush**{ XE "Brush:Charity (1857-)" \f "Name" \b } was born in perh{ XE "USA, New York, Ontario, Phelps, perh: :Brush, Charity (1857-)" \f "Place" } in 1857.
Charity married **Edward F Walker**{ XE "Walker:Edward F" \f "Name" \b \i }.

Charlotte Brush{ TC "Charlotte Brush" \I 3 \f C}

207. Charlotte A⁵ Brush{ XE "Brush:Charlotte A (1819-)" \f "Name" \b } (*Elizabeth⁴ Sears, Capt Knowles³, James²*) was born in 1819. She was the daughter of Joseph Bennett Brush{ XE "Brush:Joseph Bennett (1786-1858)" \f "Name" \i } (31) and Elizabeth Sears{ XE "Sears:Elizabeth (1790-1880)" \f "Name" \i } (30).

Charlotte A died in Geneva, Walworth, Wisconsin, USA{ XE "USA, Wisconsin, Walworth, Geneva:(42.6205° N, 88.487° W):Brush, Charlotte A (1819-)" \f "Place" }.

Marriages with David M Keeler Col and Myron S Barnes (Page 256) are known.

⁴⁰⁹ Ancestry.com and The Church of Jesus Christ of Latter-day Saints, 1880 United States Federal Census (Provo, UT, USA, Ancestry.com Operations Inc, 2010), Ancestry.com, Year: 1880; Census Place: Huron, Wayne, New York; Roll: 944; Page: 157C; Enumeration District: 177. Record for James S. Brush.
<http://search.ancestry.com/cgi-bin/sse.dll?db=6742&h=39474443&indiv=try>.

Family of Charlotte Brush and David Col { TC "Charlotte Brush and David Col" \I 4 \f C}

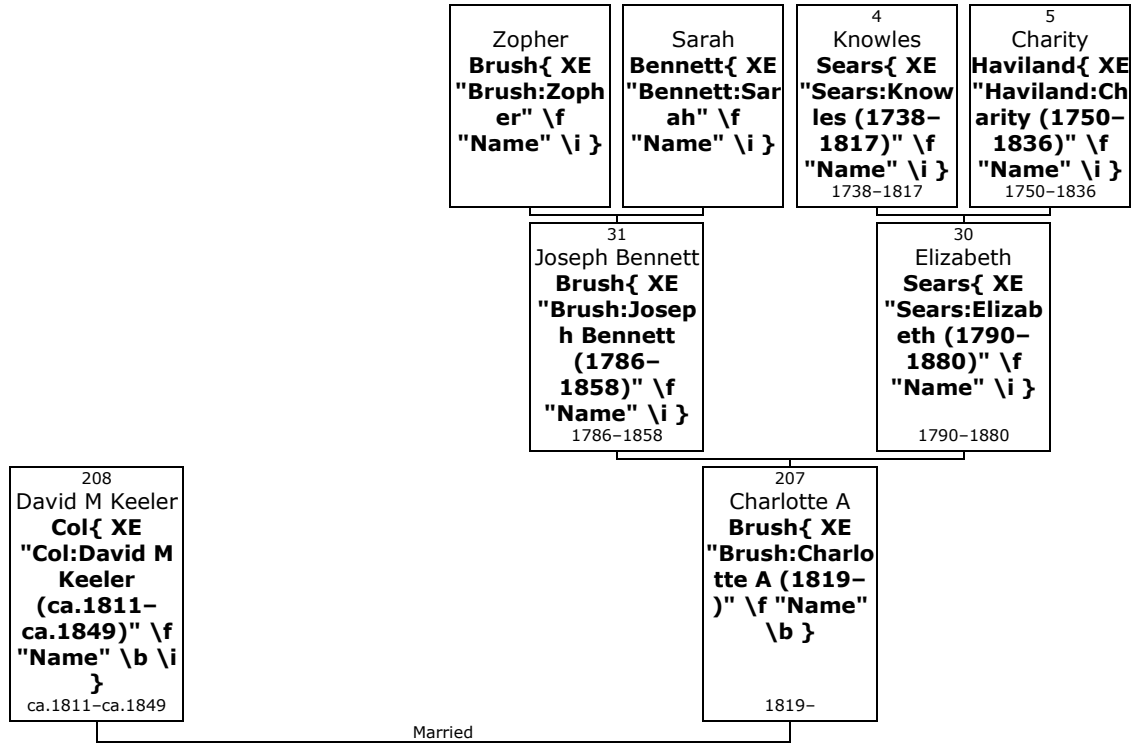

Here are the details about **Charlotte A Brush's** { XE "Brush:Charlotte A (1819-)" \f "Name" \b } first marriage, with David M Keeler Col. You can read more about Charlotte A on page 254.

208. Charlotte A Brush married **David M Keeler Col** { XE "Col:David M Keeler (ca.1811-ca.1849)" \f "Name" \b \i }. They had no known children.

David M Keeler was born about 1811. He reached 38 years of age and died about 1849.

Col David Keeler did not remove to Geneva, Ill. as stated in the Sears Genealogy nor did he die there. He went to Geneva, Wisconsin where he became owner and editor of a newspaper called the "Wisconsin Standard," which lived only about six months, as Col. Keeler died aged 38 years shortly after settling there. The paper existed during a part of the year 1849, which is probably the year of the death of Col. Keeler as his widow married Myron S Barnes in 1853 and died in Galesburg, Ill in 1904.

Family of Charlotte Brush and Myron Barnes{ TC "Charlotte Brush and Myron Barnes" \I 4 \f C}

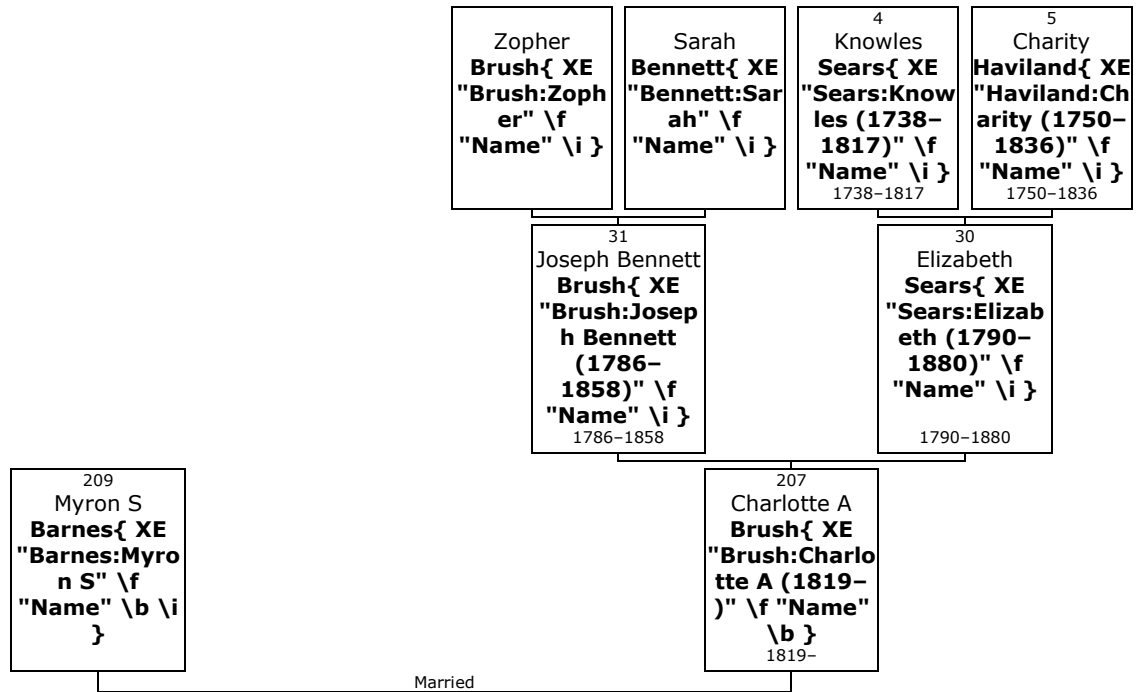

Here are the details about **Charlotte A Brush's**{ XE "Brush:Charlotte A (1819-)" \f "Name" \b } second marriage, with Myron S Barnes. You can read more about Charlotte A on page 254.

209. Charlotte A married **Myron S Barnes**{ XE "Barnes:Myron S" \f "Name" \b \i }.

Family of Mary Brush and Gordon Tracy{ TC "Mary Brush and Gordon Tracy" \I 3 \f C}

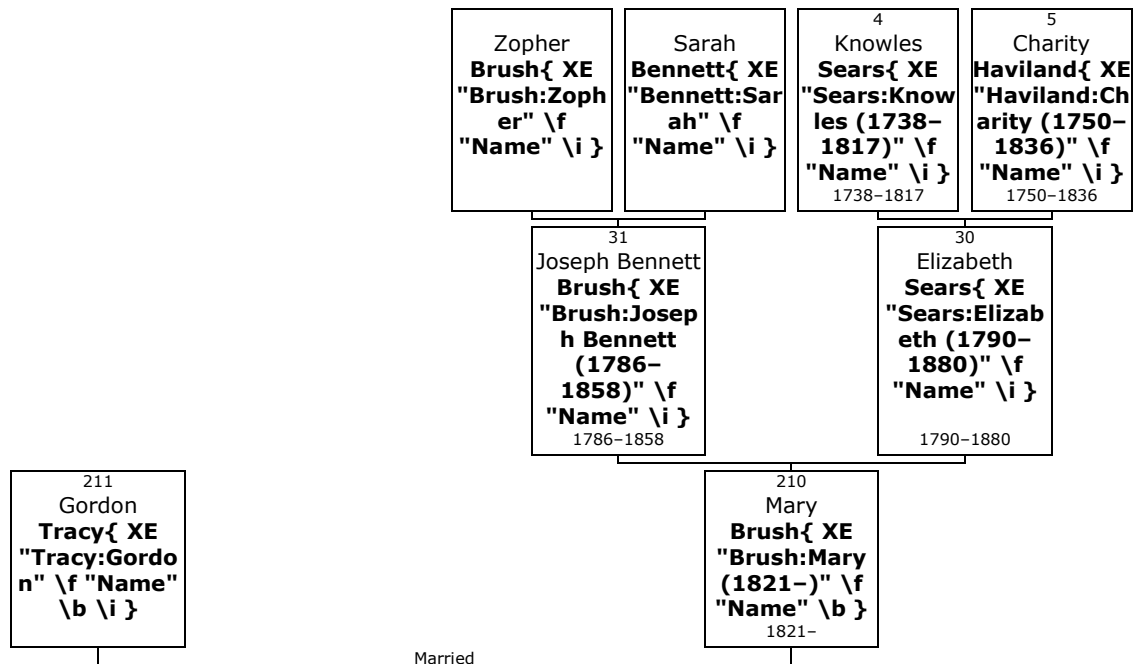

210. **Mary⁵ Brush**{ XE "Brush:Mary (1821-)" \f "Name" \b } (*Elizabeth⁴ Sears, Capt Knowles³, James²*) was born in 1821. She was the daughter of Joseph Bennett Brush{ XE "Brush:Joseph Bennett (1786-1858)" \f "Name" \i } (31) and Elizabeth Sears{ XE "Sears:Elizabeth (1790-1880)" \f "Name" \i } (30).

211. She married **Gordon Tracy**{ XE "Tracy:Gordon" \f "Name" \b \i }.

Family of Ann Brush and John Benedict{ TC "Ann Brush and John Benedict" \I 3 \f C}

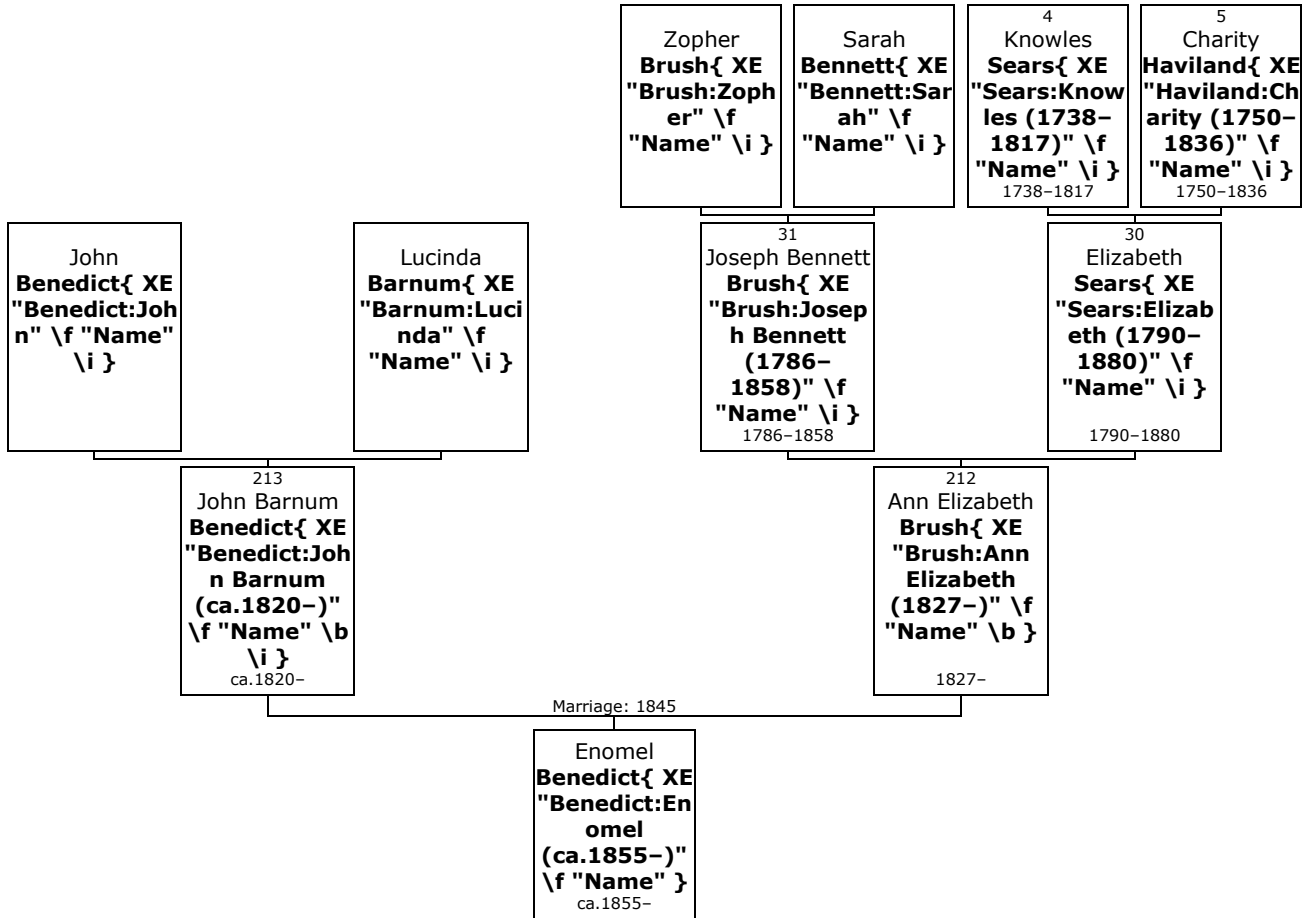

212. **Ann Elizabeth⁵ Brush**{ XE "Brush:Ann Elizabeth (1827-)" \f "Name" \b } (*Elizabeth⁴ Sears, Capt Knowles³, James²*) was born on Sunday, 20th May 1827.^[410] She was the daughter of Joseph Bennett Brush{ XE "Brush:Joseph Bennett (1786-1858)" \f "Name" \i } (31) and Elizabeth Sears{ XE "Sears:Elizabeth (1790-1880)" \f "Name" \i } (30).

!SPM shows name Elizabeth

!Desc of Thomas & Richard Brush says aka Ann Elizabeth

More facts and events for Ann Elizabeth Brush:

Residence: 1855 Ward 6{ XE "USA, New York, Monroe, Rochester, Ward 6: :Brush, Ann Elizabeth (1827-)" \f "Place" }^[410]
 Relation to Head: Wife

213. Ann Elizabeth married **John Barnum Benedict**{ XE "Benedict:John Barnum (ca.1820-)" \f "Name" \b \i } on Sunday, 16th February 1845.^[410] They had one son: Enomel (ca.1855-).

John Barnum was born about 1820.^[410] He was the son of John Benedict{ XE "Benedict:John" \f "Name" \i } and Lucinda Barnum{ XE "Barnum:Lucinda" \f "Name" \i }.

More facts and events for John Barnum Benedict:

Residence: 1855 Ward 6{ XE "USA, New York, Monroe, Rochester, Ward 6: :Benedict, John Barnum (ca.1820-)" \f "Place" }^[410]
 Relation to Head: Boarder

⁴¹⁰ Ancestry.com, New York, State Census, 1855 (Provo, UT, USA, Ancestry.com Operations, Inc., 2013), Ancestry.com. [Source citation includes one media item]

Son of Ann Elizabeth Brush and John Barnum Benedict:

m I. **Enomel⁶ Benedict**{ XE "Benedict:Enomel (ca.1855-)" \f "Name" \b } was born about 1855.^[410]

More facts and events for Enomel Benedict:

Residence: 1855 Ward 6{ XE "USA, New York, Monroe, Rochester, Ward 6: :Benedict, Enomel (ca.1855-)" \f "Place" }^[410]

Relation to Head: Child

Family of William Brush and Sabra Wood{ TC "William Brush and Sabra Wood" \I 3 \f C}

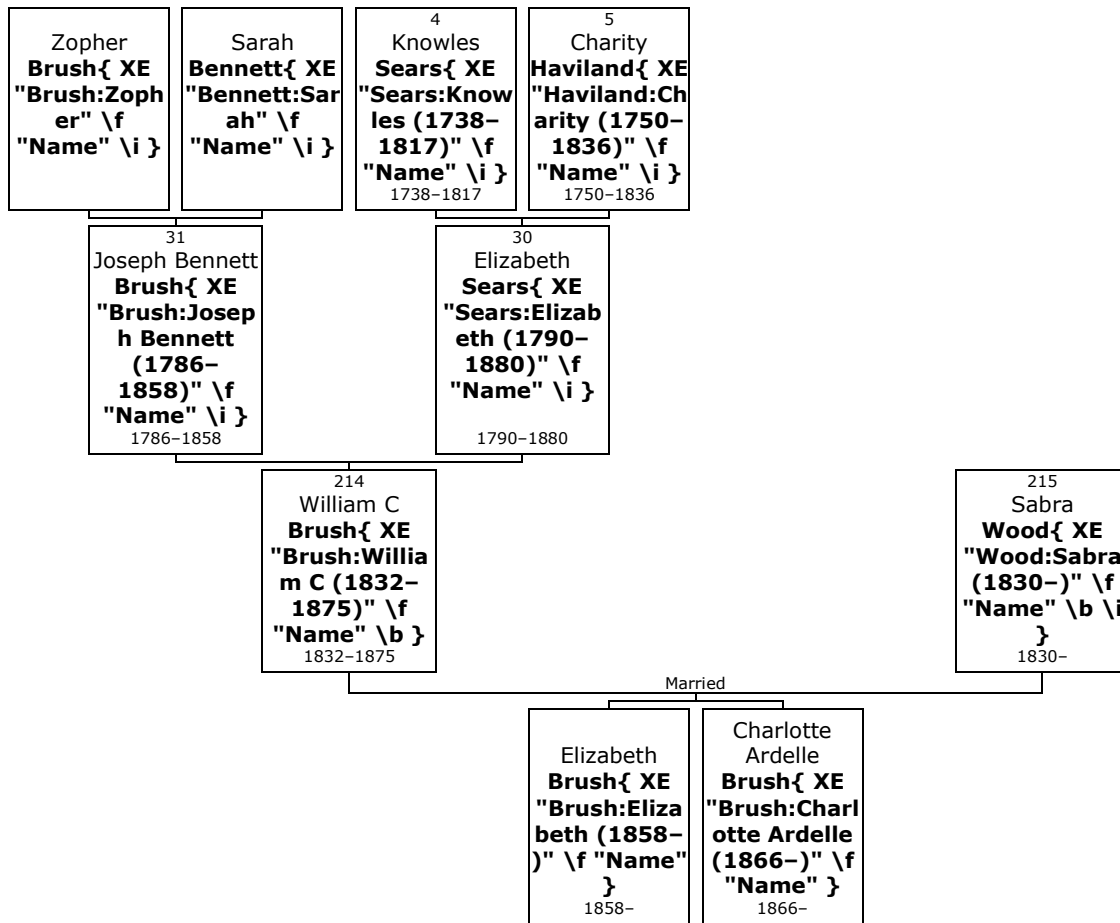

214. William C⁵ Brush{ XE "Brush:William C (1832-1875)" \f "Name" \b } (*Elizabeth⁴ Sears, Capt Knowles³, James²*) was born in 1832. He was the son of Joseph Bennett Brush{ XE "Brush:Joseph Bennett (1786-1858)" \f "Name" \i } (31) and Elizabeth Sears{ XE "Sears:Elizabeth (1790-1880)" \f "Name" \i } (30).

William C died in 1875 at the age of 43.

215. He married **Sabra Wood**{ XE "Wood:Sabra (1830-)" \f "Name" \b \i }. They had two daughters: Elizabeth (1858-) and Charlotte (1866-).

Sabra was born in 1830.

Daughters of William C Brush and Sabra Wood:

f I. **Elizabeth⁶ Brush**{ XE "Brush:Elizabeth (1858-)" \f "Name" \b } was born in 1858.

f II. **Charlotte Ardelle Brush**{ XE "Brush:Charlotte Ardelle (1866-)" \f "Name" \b } was born in 1866.

Charlotte Ardelle married **Peter Degreater**{ XE "Degreater:Peter" \f "Name" \b \i }.

Grandchildren{ TC "Grandchildren" \I 2 \f C}

Family of Abel Sherwood and Mary Durst{ TC "Abel Sherwood and Mary Durst" \I 3 \f C}

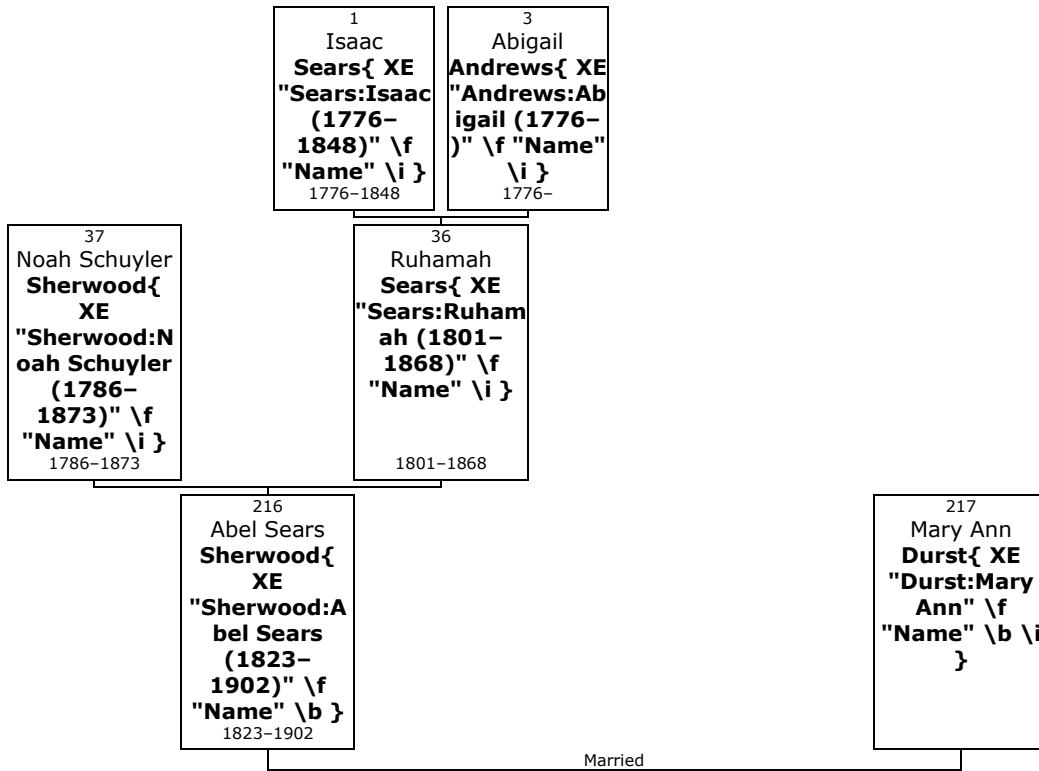

- 216.** **Abel Sears⁶ Sherwood**{ XE "Sherwood:Abel Sears (1823-1902)" \f "Name" \b } (*Ruhamah⁵ Sears, Isaac⁴, Susanna³ Townsend*) was born on Wednesday, 1st January 1823.^[411] He was the son of Noah Schuyler Sherwood{ XE "Sherwood:Noah Schuyler (1786-1873)" \f "Name" \i } (37) and Ruhamah Sears{ XE "Sears:Ruhamah (1801-1868)" \f "Name" \i } (36).

Abel Sears died in 1902 at the age of 79.^[411] He was buried in Somerset, Niagara County, New York, USA{ XE "USA, New York, Niagara County, Somerset:(43.3475° N, 78.5561° W):Sherwood, Abel Sears (1823-1902)" \f "Place" \b }.^[411]

- 217.** He married **Mary Ann Durst**{ XE "Durst:Mary Ann" \f "Name" \b \i }.

⁴¹¹ Ancestry.com, U.S., Find A Grave Index, 1600s-Current (Provo, UT, USA, Ancestry.com Operations, Inc., 2012), Ancestry.com.

Family of Elam Sherwood and Susannah Dewhurst{ TC "Elam Sherwood and Susannah Dewhurst" \I 3 \f C}

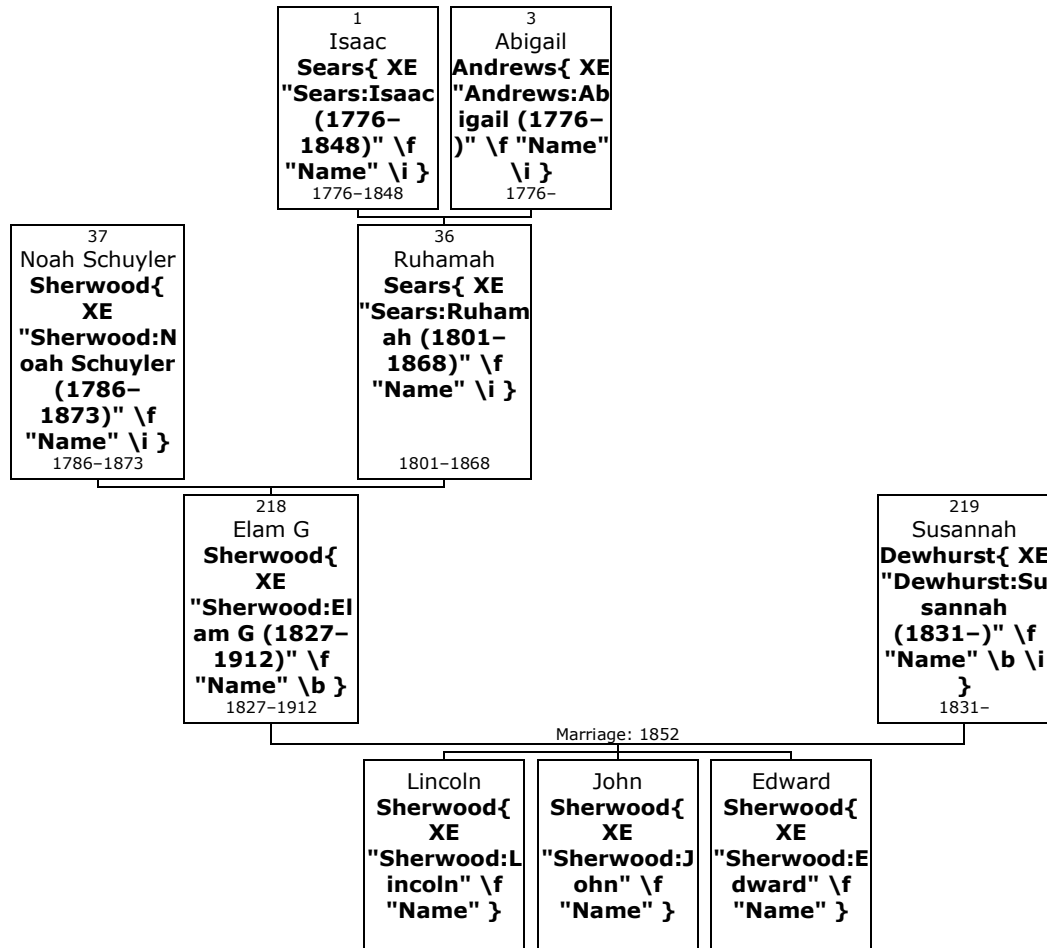

- 218. Elam G⁶ Sherwood**{ XE "Sherwood:Elam G (1827-1912)" \f "Name" \b } (*Ruhamah⁵ Sears, Isaac⁴, Susanna³ Townsend*) was born on Thursday, 10th May 1827, in Hartland, Niagara, New York, USA{ XE "USA, New York, Niagara, Hartland:(43.24° N, 78.5764° W):Sherwood, Elam G (1827-1912)" \f "Place" }.^[412, 413] He was the son of Noah Schuyler Sherwood{ XE "Sherwood:Noah Schuyler (1786-1873)" \f "Name" \i } (37) and Ruhamah Sears{ XE "Sears:Ruhamah (1801-1868)" \f "Name" \i } (36). He was also known as **Elon**{ XE "Sherwood:Elon (Elam G. Sherwood) (1827-1912)" \f "Name" }.^[412]

Elam G died in Niagara{ XE "USA, New York, Niagara:(43.3239° N, 78.7939° W):Sherwood, Elam G (1827-1912)" \f "Place" } on 24th November 1912, at the age of 85.^[412, 413] He was buried in Somerset, Niagara County{ XE "USA, New York, Niagara County, Somerset:(43.3475° N, 78.5561° W):Sherwood, Elam G (1827-1912)" \f "Place" }.^[413]

- 219.** Elam G married **Susannah Dewhurst**{ XE "Dewhurst:Susannah (1831-)" \f "Name" \b \i } on Tuesday, 9th March 1852, in perh, Hartland, Niagara{ XE "USA, New York, Niagara, Hartland, perh: :Sherwood, Elam G (1827-1912)" \f "Place" }.^[412] They had three sons: Lincoln, John and Edward.

Susannah was born in perh{ XE "USA, New York, Niagara, Hartland, perh: :Dewhurst, Susannah (1831-)" \f "Place" } in 1831.

Sons of Elam G Sherwood and Susannah Dewhurst:

- m I. **Lincoln⁷ Sherwood**{ XE "Sherwood:Lincoln" \f "Name" \b }.

⁴¹² FamilySearch.org, FamilySearch Family Tree, FamilySearch, "Family Tree," database, <i>FamilySearch</i> (<http://familysearch.org> : modified 08 July 2017, 15:03), entry for Elam G. Sherwood(PID <https://familysearch.org/ark:/61903/4:1:KCN1-TPL>); contributed by various users. PersonID KCN1-TPL. Elam G. Sherwood. <https://familysearch.org/ark:/61903/4:1:KCN1-TPL>.

⁴¹³ Ancestry.com, U.S., Find A Grave Index, 1600s-Current (Provo, UT, USA, Ancestry.com Operations, Inc., 2012), Ancestry.com.

m II. **John Sherwood**{ XE "Sherwood:John" \f "Name" \b }.

m III. **Edward Sherwood**{ XE "Sherwood:Edward" \f "Name" \b }.

Family of Jones Sherwood and Frances Hibbard{ TC "Jones Sherwood and Frances Hibbard" \I 3 \f C}

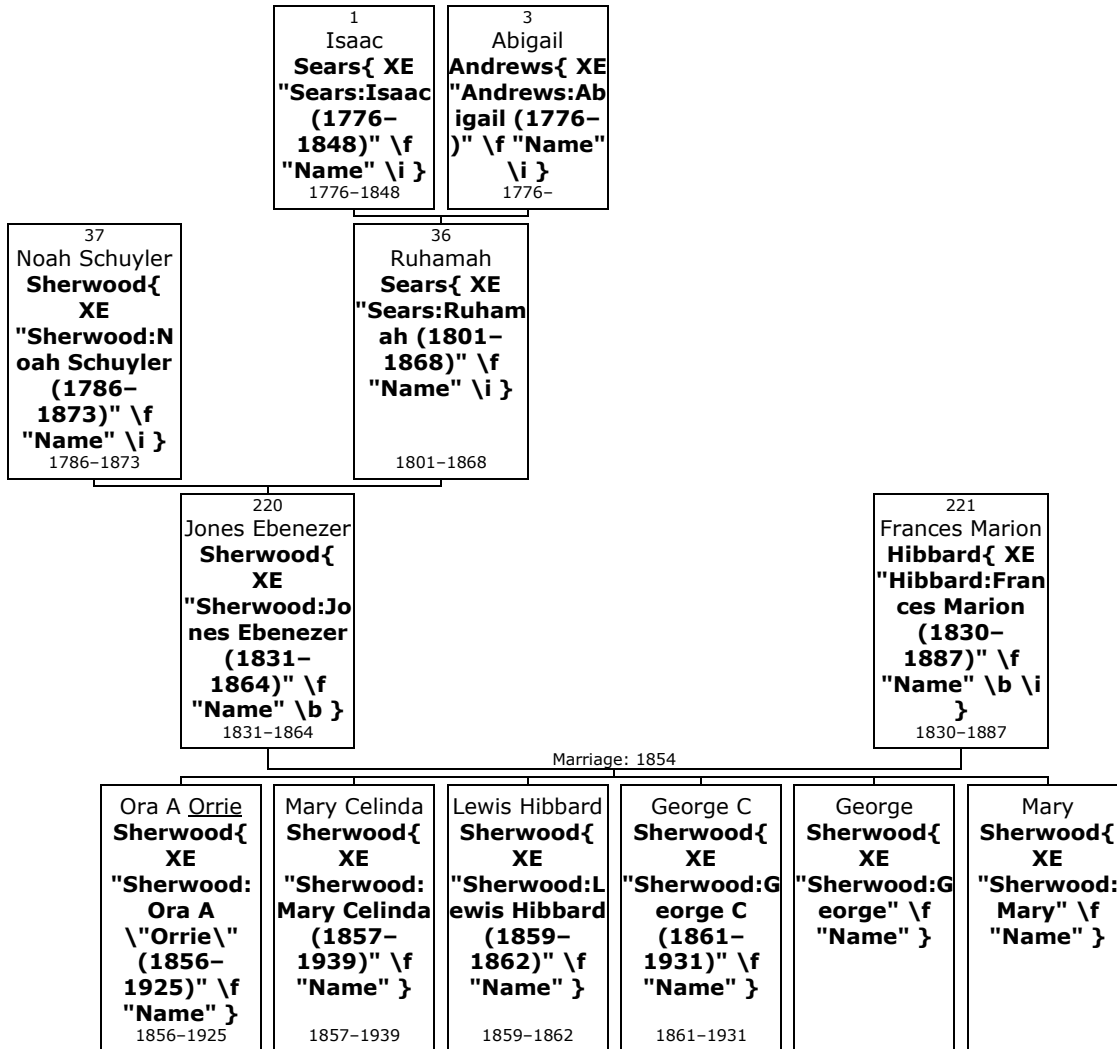

220. Pvt Jones Ebenezer⁶ Sherwood{ XE "Sherwood:Jones Ebenezer (1831-1864)" \f "Name" \b } (*Ruhamah⁵ Sears, Isaac⁴, Susanna³ Townsend*) was born on Sunday, 29th May 1831, in Clarkson, Monroe, New York, USA{ XE "USA, New York, Monroe, Clarkson:(43.2331° N, 77.9278° W):Sherwood, Jones Ebenezer (1831-1864)" \f "Place" \i }.^[414, 415, 416, 417, 418, 419, 420-421] He was the son of Noah Schuyler

⁴¹⁴ Ancestry.com, U.S., Find A Grave Index, 1600s-Current (Provo, UT, USA, Ancestry.com Operations, Inc., 2012), Ancestry.com.

⁴¹⁵ Ancestry.com, New York, State Census, 1865 (Provo, UT, USA, Ancestry.com Operations, Inc., 2014), Ancestry.com. [Source citation includes one media item]

⁴¹⁶ Ancestry.com, New York, Registers of Officers and Enlisted Men Mustered into Federal Service, 1861-1865 (Provo, UT, USA, Ancestry.com Operations, Inc., 2014), Ancestry.com. [Source citation includes one media item]

⁴¹⁷ Ancestry.com, Andersonville Prisoners of War (Provo, UT, USA, Ancestry.com Operations Inc, 1999), Ancestry.com.

⁴¹⁸ Ancestry.com, Web: Georgia, Find A Grave Index, 1728-2012 (Provo, UT, USA, Ancestry.com Operations, Inc., 2012), Ancestry.com.

⁴¹⁹ Ancestry.com, U.S., Burial Registers, Military Posts and National Cemeteries, 1862-1960 (Provo, UT, USA, Ancestry.com Operations, Inc., 2012), Ancestry.com. [Source citation includes one media item]

Sherwood{ XE "Sherwood:Noah Schuyler (1786–1873)" \f "Name" \i } (37) and Ruhamah Sears{ XE "Sears:Ruhamah (1801–1868)" \f "Name" \i } (36).

Jones Ebenezer served in the military in Hartland, Niagara,{ XE "USA, New York, Niagara, Hartland:(43.24° N, 78.5764° W):Sherwood, Jones Ebenezer (1831–1864)" \f "Place" } on 29th July 1863.^[416] He served in the military in New York{ XE "USA, New York:(42.7531° N, 74.2224° W):Sherwood, Jones Ebenezer (1831–1864)" \f "Place" }.^[417] Jones Ebenezer served in the military in New York{ XE "USA, New York:(42.7531° N, 74.2224° W):Sherwood, Jones Ebenezer (1831–1864)" \f "Place" }.^[420]

He died in Fort Sumter, Andersonville, Sumter, Georgia,{ XE "USA, Georgia, Sumter, Andersonville, Fort Sumter: :Sherwood, Jones Ebenezer (1831–1864)" \f "Place" } on 4th August 1864, at the age of 33.^[414, 417–421] Jones Ebenezer was buried in Andersonville, Sumter County{ XE "USA, Georgia, Sumter County, Andersonville:(32.196° N, 84.1399° W):Sherwood, Jones Ebenezer (1831–1864)" \f "Place" }.^[414, 418, 419, 421]

died at Andersonville

More facts and events for Jones Ebenezer Sherwood:

Residence: 1865 Hartland, Niagara, New York{ XE "USA, New York, Niagara, Hartland:(43.24° N, 78.5764° W):Sherwood, Jones Ebenezer (1831–1864)" \f "Place" }.^[415]
Relation to Head of House: Head

- 221.** At the age of 22, Jones Ebenezer married **Frances Marion Hibbard**{ XE "Hibbard:Frances Marion (1830–1887)" \f "Name" \b \i } on Thursday, 2nd February 1854, in Niagara{ XE "USA, New York, Niagara, Niagara:(43.1153° N, 78.9812° W):Sherwood, Jones Ebenezer (1831–1864)" \f "Place" } when she was 23 years old.^[415] They had six children: Orrie (1856–1925), Mary (1857–1939), Lewis (1859–1862), George (1861–1931), George and Mary.

Frances Marion was born in Pomfret, Windham, Connecticut,{ XE "USA, Connecticut, Windham, Pomfret:(41.8975° N, 71.963° W):Hibbard, Frances Marion (1830–1887)" \f "Place" } on Friday, 7th May 1830.^[415] She reached 57 years of age and died in Somerset{ XE "USA, New York, Niagara, Somerset:(43.3475° N, 78.5561° W):Hibbard, Frances Marion (1830–1887)" \f "Place" } on 29th August 1887.

More facts and events for Frances Marion Hibbard:

Residence: 1865 Hartland{ XE "USA, New York, Niagara, Hartland:(43.24° N, 78.5764° W):Hibbard, Frances Marion (1830–1887)" \f "Place" }.^[415]
Relation to Head of House: Wife

Children of Jones Ebenezer Sherwood and Frances Marion Hibbard:

- f I. **Ora A Orrie⁷ Sherwood**{ XE "Sherwood:Ora A \"Orrie\" (1856–1925)" \f "Name" \b \i } was born in Somerset{ XE "USA, New York, Niagara, Somerset:(43.3475° N, 78.5561° W):Sherwood, Ora A \"Orrie\" (1856–1925)" \f "Place" } on 15th January 1856.^[415] She died in Niagara{ XE "USA, New York, Niagara, Niagara:(43.1153° N, 78.9812° W):Sherwood, Ora A \"Orrie\" (1856–1925)" \f "Place" } on 12th July 1925, at the age of 69.

More facts and events for Ora A Orrie Sherwood:

Residence: 1865 Hartland{ XE "USA, New York, Niagara, Hartland:(43.24° N, 78.5764° W):Sherwood, Ora A \"Orrie\" (1856–1925)" \f "Place" }.^[415]
Relation to Head of House: Son

⁴²⁰ Ancestry.com, U.S., Registers of Deaths of Volunteers, 1861-1865 (Provo, UT, USA, Ancestry.com Operations, Inc., 2012), Ancestry.com.
[Source citation includes one media item]

⁴²¹ Ancestry.com, U.S. National Cemetery Interment Control Forms, 1928-1962 (Provo, UT, USA, Ancestry.com Operations, Inc., 2012), Ancestry.com.
[Source citation includes one media item]

- f II. **Mary Celinda Sherwood**{ XE "Sherwood:Mary Celinda (1857–1939)" \f "Name" \b } was born in Somerset{ XE "USA, New York, Niagara, Somerset:(43.3475° N, 78.5561° W):Sherwood, Mary Celinda (1857–1939)" \f "Place" } on 19th April 1857.^[415] She died in Niagara{ XE "USA, New York, Niagara, Niagara:(43.1153° N, 78.9812° W):Sherwood, Mary Celinda (1857–1939)" \f "Place" } on 13th March 1939, at the age of 81.
- More facts and events for Mary Celinda Sherwood:
- Residence: 1865 Hartland{ XE "USA, New York, Niagara, Hartland:(43.24° N, 78.5764° W):Sherwood, Mary Celinda (1857–1939)" \f "Place" }^[415]
- Relation to Head of House: Daughter
- m III. **Lewis Hibbard Sherwood**{ XE "Sherwood:Lewis Hibbard (1859–1862)" \f "Name" \b } was born in Niagara{ XE "USA, New York, Niagara, Niagara:(43.1153° N, 78.9812° W):Sherwood, Lewis Hibbard (1859–1862)" \f "Place" } on 8th March 1859. He died in Niagara{ XE "USA, New York, Niagara, Niagara:(43.1153° N, 78.9812° W):Sherwood, Lewis Hibbard (1859–1862)" \f "Place" } on 29th May 1862, at the age of 3.
- m IV. **George C Sherwood**{ XE "Sherwood:George C (1861–1931)" \f "Name" \b } was born in Hartland{ XE "USA, New York, Niagara, Hartland:(43.24° N, 78.5764° W):Sherwood, George C (1861–1931)" \f "Place" } on 7th August 1861.^[415] He died in Niagara{ XE "USA, New York, Niagara, Niagara:(43.1153° N, 78.9812° W):Sherwood, George C (1861–1931)" \f "Place" } on 1st April 1931, at the age of 69.
- More facts and events for George C Sherwood:
- Residence: 1865 Hartland{ XE "USA, New York, Niagara, Hartland:(43.24° N, 78.5764° W):Sherwood, George C (1861–1931)" \f "Place" }^[415]
- Relation to Head of House: Son
- m V. **George Sherwood**{ XE "Sherwood:George" \f "Name" \b }.
- f VI. **Mary Sherwood**{ XE "Sherwood:Mary" \f "Name" \b }.
- Mary married **Wren Wilson**{ XE "Wilson:Wren" \f "Name" \b \i }.

Family of John Sherwood and Mary Hess{ TC "John Sherwood and Mary Hess" \I 3 \f C}

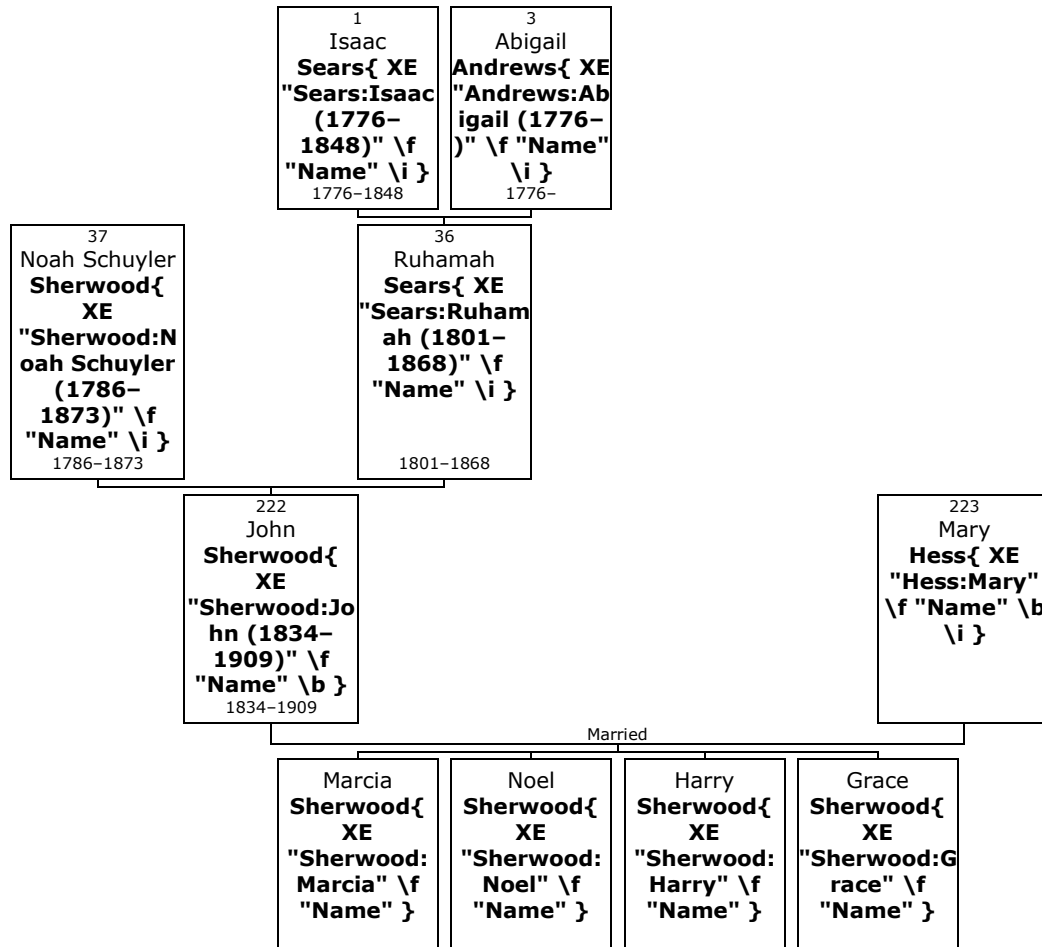

- 222.** **John⁶ Sherwood**{ XE "Sherwood:John (1834-1909)" \f "Name" \b } (*Ruhamah⁵ Sears, Isaac⁴, Susanna³ Townsend*) was born on Monday, 27th October 1834, in New York, USA{ XE "USA, New York:(42.7531° N, 74.2224° W):Sherwood, John (1834-1909)" \f "Place" }.^[422] He was the son of Noah Schuyler Sherwood{ XE "Sherwood:Noah Schuyler (1786-1873)" \f "Name" \i } (37) and Ruhamah Sears{ XE "Sears:Ruhamah (1801-1868)" \f "Name" \i } (36).

John died in 1909 at the age of 74.^[422] He was buried in Somerset, Niagara County, New York{ XE "USA, New York, Niagara County, Somerset:(43.3475° N, 78.5561° W):Sherwood, John (1834-1909)" \f "Place" }.^[422]

- 223.** He married **Mary Hess**{ XE "Hess:Mary" \f "Name" \b \i }. They had four children: Marcia, Noel, Harry and Grace.

Children of John Sherwood and Mary Hess:

- f I. **Marcia⁷ Sherwood**{ XE "Sherwood:Marcia" \f "Name" \b }.
- m II. **Noel Sherwood**{ XE "Sherwood:Noel" \f "Name" \b }.
- m III. **Harry Sherwood**{ XE "Sherwood:Harry" \f "Name" \b }.
- f IV. **Grace Sherwood**{ XE "Sherwood:Grace" \f "Name" \b }.

Grace married **Fred Sawyer**{ XE "Sawyer:Fred" \f "Name" \b \i }.

⁴²² Ancestry.com, U.S., Find A Grave Index, 1600s-Current (Provo, UT, USA, Ancestry.com Operations, Inc., 2012), Ancestry.com.

Family of Myron Sherwood and Emily Spalding{ TC "Myron Sherwood and Emily Spalding" \I 3 \f C}

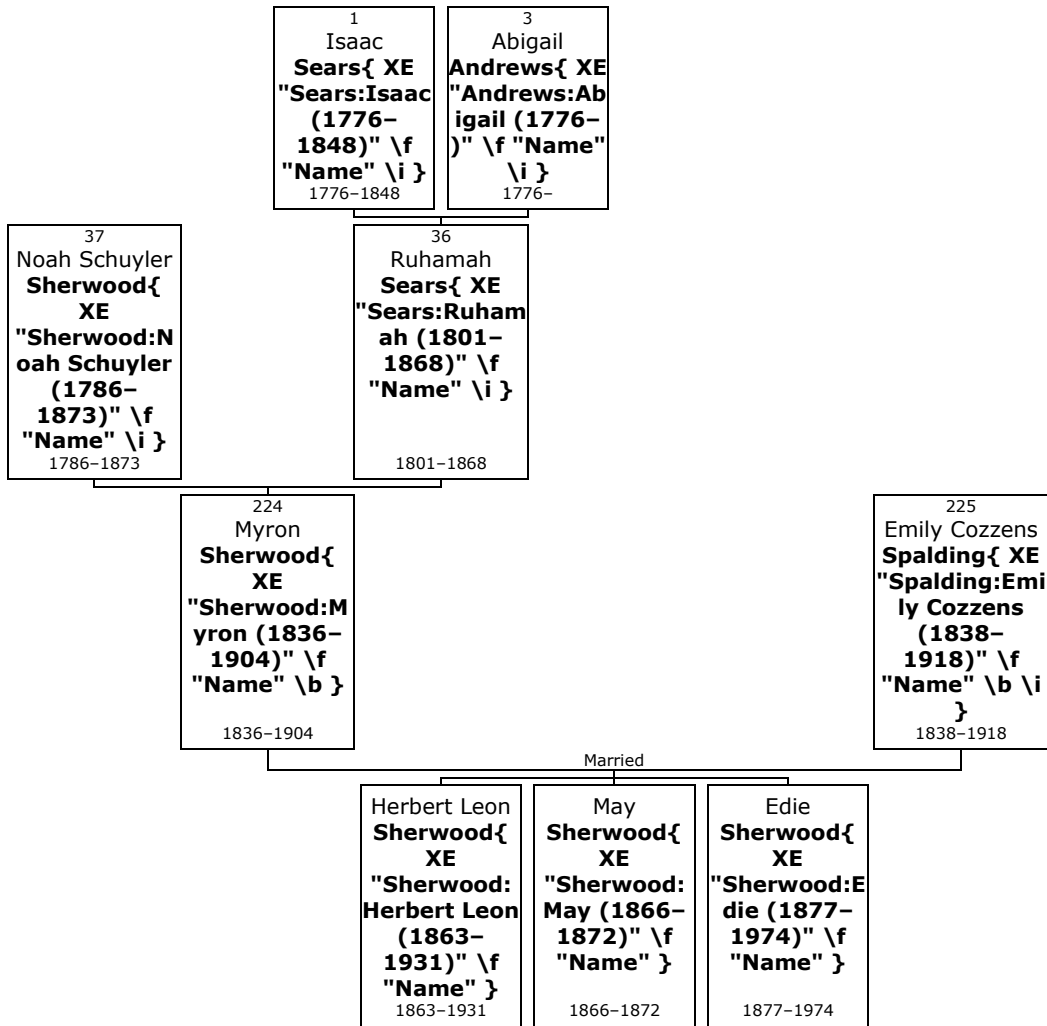

224. **Myron⁶ Sherwood**{ XE "Sherwood:Myron (1836-1904)" \f "Name" \b } (*Ruhamah⁵ Sears, Isaac⁴, Susanna³ Townsend*) was born on Wednesday, 13th July 1836, in Somerset, Niagara, New York, USA{ XE "USA, New York, Niagara, Somerset:(43.3475° N, 78.5561° W):Sherwood, Myron (1836-1904)" \f "Place" }.^[423, 424, 425, 426, 427, 428, 429, 430, 431-432] He was the son of Noah Schuyler Sherwood{ XE "Sherwood:Noah

⁴²³ Ancestry.com, U.S., Find A Grave Index, 1600s-Current (Provo, UT, USA, Ancestry.com Operations, Inc., 2012), Ancestry.com.

⁴²⁴ FamilySearch.org, FamilySearch Family Tree, FamilySearch, "Family Tree," database, <i>FamilySearch</i> (http://familysearch.org : modified 17 March 2018, 20:08), entry for Myron Sherwood(PID https://familysearch.org/ark:/61903/4:1:KZ7B-TZY); contributed by various users. PersonID KZ7B-TZY. Myron Sherwood. https://familysearch.org/ark:/61903/4:1:KZ7B-TZY.

⁴²⁵ FamilySearch.org, FamilySearch Family Tree, FamilySearch, "United States Census, 1860," database with images, <i>FamilySearch</i> (https://familysearch.org/ark:/61903/1:1:MCWV-MLQ : 12 December 2017), Myron Sherwood in entry for John Collard, 1860. Myron Sherwood in household of John Collard, "United States Census, 1860". https://familysearch.org/ark:/61903/1:1:MCWV-MLQ.

⁴²⁶ FamilySearch.org, FamilySearch Family Tree, FamilySearch, "New York State Census, 1855," database with images, <i>FamilySearch</i> (https://familysearch.org/ark:/61903/1:1:K67T-SZJ : 13 March 2018), Myron Sherwood in household of Noah Sherwood, Somerset, Niagara, New York, United States; citing p. , line #31, fa. Myron Sherwood in household of Noah Sherwood, "New York State Census, 1855". https://familysearch.org/ark:/61903/1:1:K67T-SZJ.

⁴²⁷ FamilySearch.org, FamilySearch Family Tree, FamilySearch, "United States Census, 1870," database with images, <i>FamilySearch</i> (https://familysearch.org/ark:/61903/1:1:M8VS-RYB : 12 April 2016), Myron Sherwood, New York, United States; citing p. 62, family 549, NARA microfilm publication M593 (Washington D.C. Myron Sherwood, "United States Census, 1870". https://familysearch.org/ark:/61903/1:1:M8VS-RYB.

Schuyler (1786–1873)" \f "Name" \i } (37) and Ruhamah Sears{ XE "Sears:Ruhamah (1801–1868)" \f "Name" \i } (36).

Myron died in 1904 at the age of 67.^[423] He was buried in Hartland{ XE "USA, New York, Niagara, Hartland:(43.24° N, 78.5764° W):Sherwood, Myron (1836–1904)" \f "Place" }.^[423]

More facts and events for Myron Sherwood:

- Residence: 1850 Somerset{ XE "USA, New York, Niagara, Somerset:(43.3475° N, 78.5561° W):Sherwood, Myron (1836–1904)" \f "Place" }.^[424]
- Residence: 1855 Somerset{ XE "USA, New York, Niagara, Somerset:(43.3475° N, 78.5561° W):Sherwood, Myron (1836–1904)" \f "Place" }.^[424]
- Residence: 1860 Newfane{ XE "USA, New York, Niagara, Newfane:(43.2867° N, 78.7103° W):Sherwood, Myron (1836–1904)" \f "Place" }.^[424]
- Residence: 1865 Newfane{ XE "USA, New York, Niagara, Newfane:(43.2867° N, 78.7103° W):Sherwood, Myron (1836–1904)" \f "Place" }.^[424]
District 1
- Residence: 1870 New York{ XE "USA, New York:(42.7531° N, 74.2224° W):Sherwood, Myron (1836–1904)" \f "Place" }.^[424]
- Residence: 1875 Hartland, Niagara, New York{ XE "USA, New York, Niagara, Hartland:(43.24° N, 78.5764° W):Sherwood, Myron (1836–1904)" \f "Place" }.^[424]
- Residence: 1880 Hartland{ XE "USA, New York, Niagara, Hartland:(43.24° N, 78.5764° W):Sherwood, Myron (1836–1904)" \f "Place" }.^[424]
- Residence: 1900 Hartland Township{ XE "USA, New York, Niagara, Hartland Township:(43.24° N, 78.5764° W):Sherwood, Myron (1836–1904)" \f "Place" }.^[424]
Election District 1 Middleport village (part)

225. He married **Emily Cozzens Spalding**{ XE "Spalding:Emily Cozzens (1838–1918)" \f "Name" \b \i }. They had three children: Herbert (1863–1931), May (1866–1872) and Edie (1877–1974).

Emily Cozzens was born in Onondaga{ XE "USA, New York, Onondaga:(43.2291° N, 76.1427° W):Spalding, Emily Cozzens (1838–1918)" \f "Place" } on Tuesday, 17th April 1838. She reached 79 years of age and died in Hartland{ XE "USA, New York, Niagara, Hartland:(43.24° N, 78.5764° W):Spalding, Emily Cozzens (1838–1918)" \f "Place" } on 13th February 1918.

More facts and events for Emily Cozzens Spalding:

- Residence: 1860 Newfane{ XE "USA, New York, Niagara, Newfane:(43.2867° N, 78.7103°

⁴²⁸ FamilySearch.org, FamilySearch Family Tree, FamilySearch, "New York State Census, 1875," database with images, <i>FamilySearch</i> (https://familysearch.org/ark:/61903/1:1:VTZG-TC3 : 11 March 2018), Myron Sherwood, Hartland, Niagara, New York, United States; citing p. 23, line 29, State Library, Albany; FHL micr. Myron Sherwood, "New York State Census, 1875". https://familysearch.org/ark:/61903/1:1:VTZG-TC3.

⁴²⁹ FamilySearch.org, FamilySearch Family Tree, FamilySearch, "New York State Census, 1865," database with images, <i>FamilySearch</i> (https://familysearch.org/ark:/61903/1:1:QVNJ-GYDJ : accessed 19 December 2018), Myron Sherwood, District 01, Newfane, Niagara, New York, United States; citing source p. 33, line 36., Myron Sherwood, "New York State Census, 1865". https://familysearch.org/ark:/61903/1:1:QVNJ-GYDJ.

⁴³⁰ FamilySearch.org, FamilySearch Family Tree, FamilySearch, "United States Census, 1900," database with images, <i>FamilySearch</i> (https://familysearch.org/ark:/61903/1:1:MS26-FXR : accessed 19 December 2018), Myron Sherwood, Hartland Township, Election District 1 Middleport village (part), Niagara, New York, Un. Myron Sherwood, "United States Census, 1900". https://familysearch.org/ark:/61903/1:1:MS26-FXR.

⁴³¹ FamilySearch.org, FamilySearch Family Tree, FamilySearch, "United States Census, 1880," database with images, <i>FamilySearch</i> (https://familysearch.org/ark:/61903/1:1:MZXZ-73P : 8 September 2017), Miron Sherwood, Hartland, Niagara, New York, United States; citing enumeration district ED 178, sheet 56D, NARA. Miron Sherwood, "United States Census, 1880". https://familysearch.org/ark:/61903/1:1:MZXZ-73P.

⁴³² FamilySearch.org, FamilySearch Family Tree, FamilySearch, "United States Census, 1850," database with images, <i>FamilySearch</i> (https://familysearch.org/ark:/61903/1:1:MCBK-ZNS : 12 April 2016), Myron Sherwood in household of Noah Sherwood, Somerset, Niagara, New York, United States; citing family 166, NARA m. Myron Sherwood in household of Noah Sherwood, "United States Census, 1850". https://familysearch.org/ark:/61903/1:1:MCBK-ZNS.

- W):Spalding, Emily Cozzens (1838–1918)" \f "Place" }
- Residence: 1865 Newfane{ XE "USA, New York, Niagara, Newfane:(43.2867° N, 78.7103° W):Spalding, Emily Cozzens (1838–1918)" \f "Place" }
District 1
- Residence: 1870 New York{ XE "USA, New York:(42.7531° N, 74.2224° W):Spalding, Emily Cozzens (1838–1918)" \f "Place" }
- Residence: 1875 Hartland, Niagara, New York{ XE "USA, New York, Niagara, Hartland:(43.24° N, 78.5764° W):Spalding, Emily Cozzens (1838–1918)" \f "Place" }
- Residence: 1880 Hartland{ XE "USA, New York, Niagara, Hartland:(43.24° N, 78.5764° W):Spalding, Emily Cozzens (1838–1918)" \f "Place" }
- Residence: 1900 Hartland Township{ XE "USA, New York, Niagara, Hartland Township:(43.24° N, 78.5764° W):Spalding, Emily Cozzens (1838–1918)" \f "Place" }
Election District 1 Middleport village (part)

Children of Myron Sherwood and Emily Cozzens Spalding:

- m I. **Herbert Leon⁷ Sherwood**{ XE "Sherwood:Herbert Leon (1863–1931)" \f "Name" \b } was born in New York{ XE "USA, New York:(42.7531° N, 74.2224° W):Sherwood, Herbert Leon (1863–1931)" \f "Place" } in 1863. He died in Los Angeles, Los Angeles, California,{ XE "USA, California, Los Angeles, Los Angeles:(34.0522° N, 118.2437° W):Sherwood, Herbert Leon (1863–1931)" \f "Place" } on 14th December 1931, at the age of 68.
- More facts and events for Herbert Leon Sherwood:
- Residence: 1865 Newfane, Niagara, New York{ XE "USA, New York, Niagara, Newfane:(43.2867° N, 78.7103° W):Sherwood, Herbert Leon (1863–1931)" \f "Place" }
District 1
- Residence: 1870 New York{ XE "USA, New York:(42.7531° N, 74.2224° W):Sherwood, Herbert Leon (1863–1931)" \f "Place" }
- Residence: 1875 Hartland, Niagara, New York{ XE "USA, New York, Niagara, Hartland:(43.24° N, 78.5764° W):Sherwood, Herbert Leon (1863–1931)" \f "Place" }
- Residence: 1880 Hartland{ XE "USA, New York, Niagara, Hartland:(43.24° N, 78.5764° W):Sherwood, Herbert Leon (1863–1931)" \f "Place" }
- f II. **May Sherwood**{ XE "Sherwood:May (1866–1872)" \f "Name" \b } was born in New York{ XE "USA, New York:(42.7531° N, 74.2224° W):Sherwood, May (1866–1872)" \f "Place" } in May 1866. May was buried in Hartland, Niagara,{ XE "USA, New York, Niagara, Hartland:(43.24° N, 78.5764° W):Sherwood, May (1866–1872)" \f "Place" } in 1872. She died in Niagara, New York,{ XE "USA, New York, Niagara:(43.3239° N, 78.7939° W):Sherwood, May (1866–1872)" \f "Place" } on 1st September 1872, at the age of 6.
- More facts and events for May Sherwood:
- Residence: 1870 New York{ XE "USA, New York:(42.7531° N, 74.2224° W):Sherwood, May (1866–1872)" \f "Place" }
- f III. **Edie Sherwood**{ XE "Sherwood:Edie (1877–1974)" \f "Name" \b } was born in New York{ XE "USA, New York:(42.7531° N, 74.2224° W):Sherwood, Edie (1877–1974)" \f "Place" } on 8th May 1877. Edie was buried in Hartland, Niagara, New York,{ XE "USA, New York, Niagara, Hartland:(43.24° N, 78.5764° W):Sherwood, Edie (1877–1974)" \f "Place" } in 1974. She died in Pasco, Florida,{ XE "USA, Florida, Pasco:(28.301° N,

82.4386° W):Sherwood, Edie (1877–1974)" \f "Place" } on 13th February 1974, at the age of 96.

More facts and events for Edie Sherwood:

- Residence: 1880 Hartland{ XE "USA, New York, Niagara, Hartland:(43.24° N, 78.5764° W):Sherwood, Edie (1877–1974)" \f "Place" }
- Residence: 1900 Hartland Township{ XE "USA, New York, Niagara, Hartland Township:(43.24° N, 78.5764° W):Sherwood, Edie (1877–1974)" \f "Place" }
Election District 1 Middleport village (part)
- Residence: 1935 Same House
- Residence: 1940 Hartland{ XE "USA, New York, Niagara, Hartland:(43.24° N, 78.5764° W):Sherwood, Edie (1877–1974)" \f "Place" }

Family of Mary Sherwood and Roxanna Putnam{ TC "Mary Sherwood and Roxanna Putnam" \I 3 \f C}

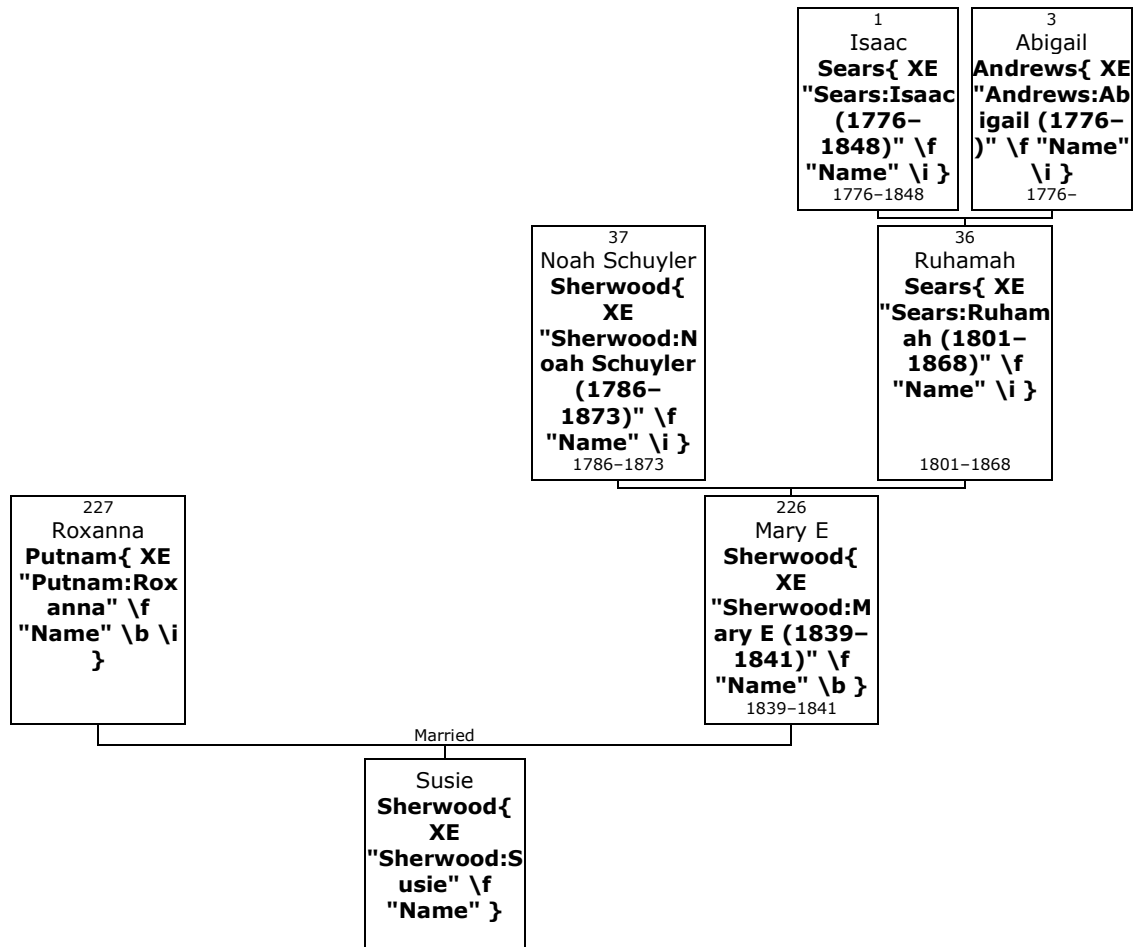

226. Mary E⁶ Sherwood{ XE "Sherwood:Mary E (1839–1841)" \f "Name" \b } (*Ruhamah⁵ Sears, Isaac⁴, Susanna³ Townsend*) was born on Sunday, 1st December 1839. She was the daughter of Noah Schuyler Sherwood{ XE "Sherwood:Noah Schuyler (1786–1873)" \f "Name" \i } (37) and Ruhamah Sears{ XE "Sears:Ruhamah (1801–1868)" \f "Name" \i } (36).

Mary E died in 1841 at the age of 1.

227. She married **Roxanna Putnam**{ XE "Putnam:Roxanna" \f "Name" \b \i }. They had one daughter: Susie. Daughter of Mary E Sherwood and Roxanna Putnam:

f I. **Susie⁷ Sherwood**{ XE "Sherwood:Susie" \f "Name" \b }.

Susie married **Elwood Folger**{ XE "Folger:Elwood" \f "Name" \b \i }.

Family of Angeline Sherwood and William Hyde{ TC "Angeline Sherwood and William Hyde" \I 3 \f C }

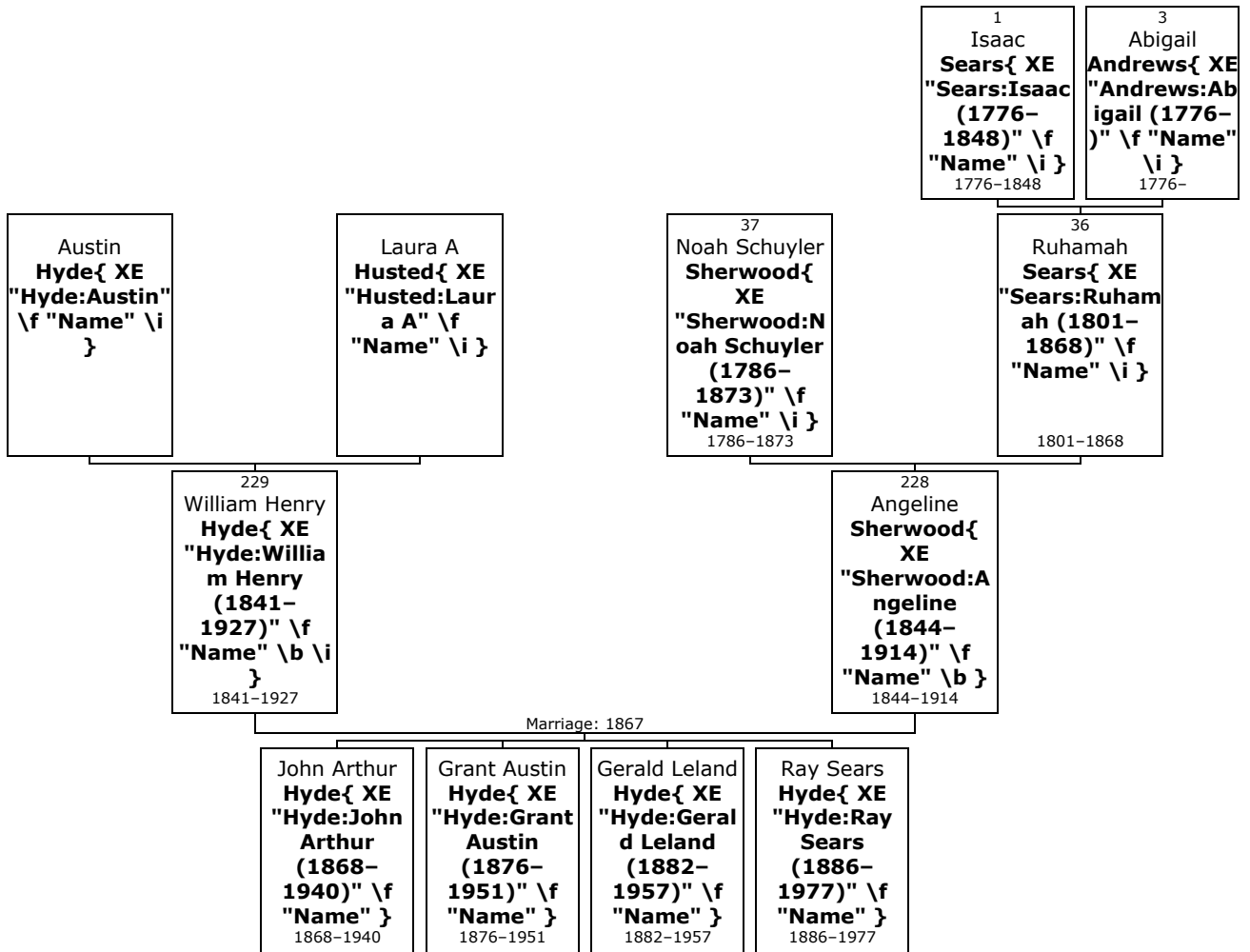

228. Angeline⁶ Sherwood{ XE "Sherwood:Angeline (1844-1914)" \f "Name" \b } (*Ruhamah⁵ Sears, Isaac⁴, Susanna³ Townsend*) was born on Sunday, 7th July 1844, in Somerset, Niagara, New York, USA{ XE "USA, New York, Niagara, Somerset:(43.3475° N, 78.5561° W):Sherwood, Angeline (1844-1914)" \f "Place" }.^[433, 434, 435, 436-437] She was the daughter of Noah Schuyler Sherwood{ XE "Sherwood:Noah Schuyler (1786-1873)" \f "Name" \i } (37) and Ruhamah Sears{ XE "Sears:Ruhamah (1801-1868)" \f "Name" \i } (36).

⁴³³ Ancestry.com, U.S., Find A Grave Index, 1600s-Current (Provo, UT, USA, Ancestry.com Operations, Inc., 2012), Ancestry.com.

⁴³⁴ FamilySearch.org, FamilySearch Family Tree, FamilySearch, "Family Tree," database, <i>FamilySearch</i> (http://familysearch.org : modified 12 September 2017, 14:43), entry for Angeline Sherwood(PID https://familysearch.org/ark:/61903/4:1:K8BR-8YS); contributed by various users. PersonID K8BR-8YS. Angeline Sherwood. https://familysearch.org/ark:/61903/4:1:K8BR-8YS.

⁴³⁵ FamilySearch.org, FamilySearch Family Tree, FamilySearch, "New York State Census, 1855," database with images, <i>FamilySearch</i> (https://familysearch.org/ark:/61903/1:1:K67T-SZK : 13 March 2018), Angelina Sherwood in household of Noah Sherwood, Somerset, Niagara, New York, United States; citing p. , line #33,. Angelina Sherwood in household of Noah Sherwood, "New York State Census, 1855". https://familysearch.org/ark:/61903/1:1:K67T-SZK.

⁴³⁶ FamilySearch.org, FamilySearch Family Tree, FamilySearch, "United States Census, 1850," database with images, <i>FamilySearch</i> (https://familysearch.org/ark:/61903/1:1:MCBK-ZNQ : 12 April 2016), Angelein Sherwood in household of Noah Sherwood, Somerset, Niagara, New York, United States; citing family 166, NAR. Angelein Sherwood in household of Noah Sherwood, "United States Census, 1850". https://familysearch.org/ark:/61903/1:1:MCBK-ZNQ.

⁴³⁷ Ancestry.com, New York, County Marriages, 1847-1849; 1907-1936 (Lehi, UT, USA, Ancestry.com Operations, Inc., 2016), Ancestry.com, Record for Ray S. Hyde. http://search.ancestry.com/cgi-bin/sse.dll?db=61377&h=571205&indiv=try. [Source citation includes one media item]

Angeline died in Genesee, Potter, Pennsylvania, { XE "USA, Pennsylvania, Potter, Genesee:(41.9892° N, 77.8661° W):Sherwood, Angeline (1844–1914)" \f "Place" } on 22nd February 1914, at the age of 69.^[433, 434] She was buried in Somerset, Niagara County, New York { XE "USA, New York, Niagara County, Somerset:(43.3475° N, 78.5561° W):Sherwood, Angeline (1844–1914)" \f "Place" }.^[433]

More facts and events for Angeline Sherwood:

Residence: 1850 Somerset, Niagara { XE "USA, New York, Niagara, Somerset:(43.3475° N, 78.5561° W):Sherwood, Angeline (1844–1914)" \f "Place" }.^[434]

Residence: 1855 Somerset { XE "USA, New York, Niagara, Somerset:(43.3475° N, 78.5561° W):Sherwood, Angeline (1844–1914)" \f "Place" }.^[434]

229. At the age of 22, Angeline married **William Henry Hyde** { XE "Hyde:William Henry (1841–1927)" \f "Name" \b \i } on Tuesday, 1st January 1867, when he was 25 years old.^[437] They had four sons: John (1868–1940), Grant (1876–1951), Gerald (1882–1957) and Ray (1886–1977).

William Henry was born on Saturday, 10th July 1841. He was the son of Austin Hyde { XE "Hyde:Austin" \f "Name" \i } and Laura A Husted { XE "Husted:Laura A" \f "Name" \i }.

William Henry reached 86 years of age and died on 6th August 1927.

Sons of Angeline Sherwood and William Henry Hyde:

m I. **John Arthur⁷ Hyde** { XE "Hyde:John Arthur (1868–1940)" \f "Name" \b } was born on 21st April 1868. He died on 29th October 1940, at the age of 72.

John Arthur married **Effie Ferguson** { XE "Ferguson:Effie" \f "Name" \b \i }.

m II. **Grant Austin Hyde** { XE "Hyde:Grant Austin (1876–1951)" \f "Name" \b } was born on 10th February 1876. He died on 15th December 1951, at the age of 75.

m III. **Gerald Leland Hyde** { XE "Hyde:Gerald Leland (1882–1957)" \f "Name" \b } was born on 17th December 1882. He died on 22nd February 1957, at the age of 74.

m IV. **Ray Sears Hyde** { XE "Hyde:Ray Sears (1886–1977)" \f "Name" \b } was born on 11th November 1886.^[437] He died on 7th February 1977, at the age of 90.

Ray Sears married **Martha P. Higgs** { XE "Higgs:Martha P. (1886–)" \f "Name" \b \i } on Wednesday, 6th January 1909, in Niagara { XE "USA, New York, Niagara:(43.3239° N, 78.7939° W):Hyde, Ray Sears (1886–1977)" \f "Place" }.^[437] They had one child: (unknown given name).

Martha P. was born in 1886.^[437]

Family of Isaac Sears and Hannah Sweet{ TC "Isaac Sears and Hannah Sweet" \I 3 \f C}

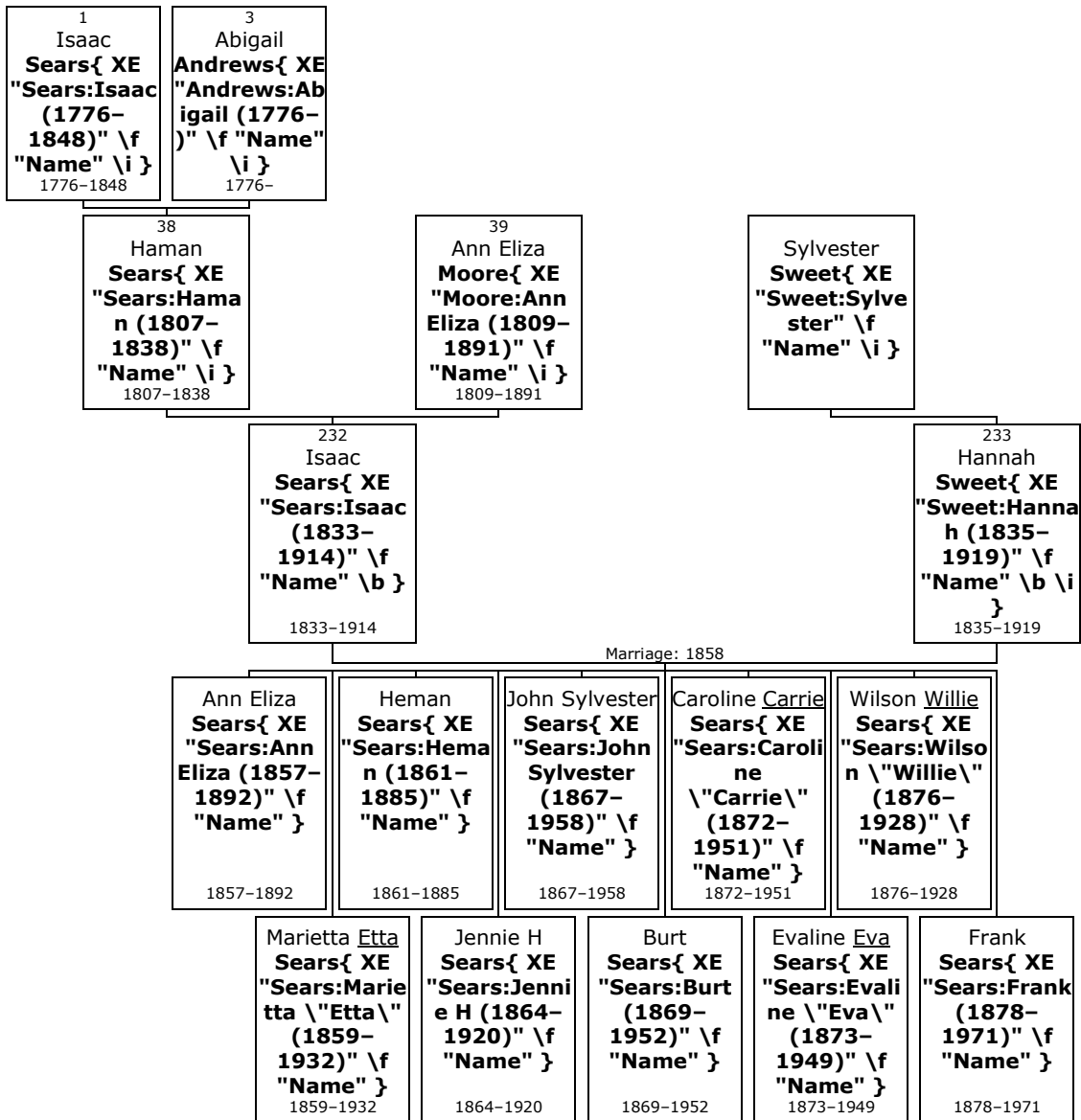

232. Isaac⁶ Sears{ XE "Sears:Isaac (1833-1914)" \f "Name" \b } (*Haman*⁵, *Isaac*⁴, *Susanna*³ *Townsend*) was born on Wednesday, 4th September 1833, in Newfane, Niagara, New York, USA{ XE "USA, New York, Niagara, Newfane:(43.2867° N, 78.7103° W):Sears, Isaac (1833-1914)" \f "Place" }.^[439, 440, 441, 442, 443]

⁴³⁹ Ancestry.com, 1910 United States Federal Census (Provo, UT, USA, Ancestry.com Operations Inc, 2006), Ancestry.com, Year: 1910; Census Place: Lockport Ward 4, Niagara, New York; Roll: T624_1049; Page: 7A; Enumeration District: 0084; FHL microfilm: 1375062.
[Source citation includes one media item]

⁴⁴⁰ Ancestry.com, New York, State Census, 1875 (Provo, UT, USA, Ancestry.com Operations, Inc., 2013), Ancestry.com.
[Source citation includes one media item]

⁴⁴¹ Ancestry.com, 1900 United States Federal Census (Provo, UT, USA, Ancestry.com Operations Inc, 2004), Ancestry.com, Year: 1900; Census Place: Newfane, Niagara, New York; Roll: 1129; Page: 10A; Enumeration District: 0067; FHL microfilm: 1241129.
[Source citation includes one media item]

⁴⁴² Ancestry.com, U.S., Find A Grave Index, 1600s-Current (Provo, UT, USA, Ancestry.com Operations, Inc., 2012), Ancestry.com.

⁴⁴³ Ancestry.com, New York, State Census, 1905 (Provo, UT, USA, Ancestry.com Operations, Inc., 2014), Ancestry.com, New York State Archives; Albany, New York; State Population Census Schedules, 1905; Election District: A.D. 02 E.D. 02; City: Newfane; County: Niagara; Page: 7.
[Source citation includes one media item]

444, 445-446] He was the son of Haman Sears{ XE "Sears:Haman (1807-1838)" \f "Name" \i } (38) and Ann Eliza Moore{ XE "Moore:Ann Eliza (1809-1891)" \f "Name" \i } (39).

Isaac died in 1914 at the age of 80.^[442] He was buried in Newfane{ XE "USA, New York, Niagara, Newfane:(43.2867° N, 78.7103° W):Sears, Isaac (1833-1914)" \f "Place" }.^[442]

!S.P. May No 2955 p.528 Is a farmer and lives on the old homestead in Newfane, Niagra county, NY.
 ! Cleary: It is believed Isaac and Hannah met on an Erie Canal packet. They lived on the Phillips Road, then moved to a house just east of his mother's home on the Drakes Settlement Road (later known as the Billie Bolger house). Afterward he bought a farm on the Fuller Road, where Loren Sears now resides. When no longer able to operate his farm he bought a house at 5 Sunnyside, Lockport where he spent his last days.
 ! 1880 United States Federal Census Name: Isaac Sears Home in 1880: Newfane, Niagara, New York Age: 47 Estimated birth year: abt 1833 Birthplace: New York Relation to Head of Household: Self (Head) Spouse's name: Hannah Father's birthplace: New York Mother's birthplace: New York Neighbors: View others on page Occupation: Farmer Marital Status: Married Race: White Gender: Male Household Members: Name Age Isaac Sears 47 Hannah Sears 45 An Eliza Sears 24 Mary E. Sears 22 Haman Sears 20 Jane Sears 17 John Sears 13 Burt Sears 11 Carrie Sears 9 Eva Sears 6 Willie Sears 5 Frank Sears 3 Charles Dunn 18

More facts and events for Isaac Sears:

Residence: 1st June 1875 Newfane{ XE "USA, New York, Niagara, Newfane:(43.2867° N, 78.7103° W):Sears, Isaac (1833-1914)" \f "Place" }.^[440]
 Relation to Head: Head

Residence: 1880 Newfane{ XE "USA, New York, Niagara, Newfane:(43.2867° N, 78.7103° W):Sears, Isaac (1833-1914)" \f "Place" }.^[444]
 Marital status: Married; Relation to Head of House: Self

Residence: 1900 Newfane{ XE "USA, New York, Niagara, Newfane:(43.2867° N, 78.7103° W):Sears, Isaac (1833-1914)" \f "Place" }.^[441]
 Marital Status: Married; Relation to Head: Head

Residence: 1905 Newfane{ XE "USA, New York, Niagara, Newfane:(43.2867° N, 78.7103° W):Sears, Isaac (1833-1914)" \f "Place" }.^[443]
 Relationship to Head: Head

Residence: 1910 Ward 4, Lockport{ XE "USA, New York, Niagara, Lockport, Ward 4: :Sears, Isaac (1833-1914)" \f "Place" }.^[439]
 Marital Status: Married; Relation to Head of House: Head

233. At the age of 25, Isaac married **Hannah Sweet**{ XE "Sweet:Hannah (1835-1919)" \f "Name" \b \i } on Tuesday, 21st December 1858, in Newfane{ XE "USA, New York, Niagara, Newfane:(43.2867° N, 78.7103° W):Sears, Isaac (1833-1914)" \f "Place" } when she was 23 years old.^[439-447] They had ten children: Ann (1857-1892), Etta (1859-1932), Heman (1861-1885), Jennie (1864-1920), John (1867-1958), Burt (1869-1952), Carrie (1872-1951), Eva (1873-1949), Willie (1876-1928) and Frank (1878-1971).

Hannah was born in Newfane{ XE "USA, New York, Niagara, Newfane:(43.2867° N, 78.7103° W):Sweet, Hannah (1835-1919)" \f "Place" } on Monday, 5th October 1835.^[439-444, 447] She was the daughter of Sylvester Sweet{ XE "Sweet:Sylvester" \f "Name" \i }.

Hannah reached 83 years of age and died in 1919.^[442] She was buried in Newfane{ XE "USA, New York, Niagara, Newfane:(43.2867° N, 78.7103° W):Sweet, Hannah (1835-1919)" \f "Place" }.^[442]

⁴⁴⁴ Ancestry.com and The Church of Jesus Christ of Latter-day Saints, 1880 United States Federal Census (Provo, UT, USA, Ancestry.com Operations Inc, 2010), Ancestry.com, Year: 1880; Census Place: Newfane, Niagara, New York; Roll: 900; Family History Film: 1254900; Page: 148C; Enumeration District: 184; Image: 0661.
 [Source citation includes one media item]

⁴⁴⁵ Ancestry.com, New York, County Marriages, 1847-1849; 1907-1936 (Lehi, UT, USA, Ancestry.com Operations, Inc., 2016), Ancestry.com.
 [Source citation includes one media item]

⁴⁴⁶ Ancestry.com, Illinois, County Marriages, 1800-1940 (Lehi, UT, USA, Ancestry.com Operations, Inc., 2016), Ancestry.com.

⁴⁴⁷ Ancestry.com, New York, State Census, 1915 (Provo, UT, USA, Ancestry.com Operations, Inc., 2012), Ancestry.com, New York State Archives; Albany, New York; State Population Census Schedules, 1915; Election District: 02; Assembly District: 01; City: Lockport Ward 08; County: Niagara; Page: 05.
 [Source citation includes one media item]

More facts and events for Hannah Sweet:

- Residence: 1st June 1875 Newfane{ XE "USA, New York, Niagara, Newfane:(43.2867° N, 78.7103° W):Sweet, Hannah (1835–1919)" \f "Place" }^[440]
Relation to Head: Wife
- Residence: 1880 Newfane{ XE "USA, New York, Niagara, Newfane:(43.2867° N, 78.7103° W):Sweet, Hannah (1835–1919)" \f "Place" }^[444]
Marital status: Married; Relation to Head of House: Wife
- Residence: 1900 Newfane{ XE "USA, New York, Niagara, Newfane:(43.2867° N, 78.7103° W):Sweet, Hannah (1835–1919)" \f "Place" }^[441]
Marital Status: Married; Relation to Head: Wife
- Residence: 1905 Newfane{ XE "USA, New York, Niagara, Newfane:(43.2867° N, 78.7103° W):Sweet, Hannah (1835–1919)" \f "Place" }^[443]
Relationship to Head: Wife
- Residence: 1910 Ward 4, Lockport{ XE "USA, New York, Niagara, Lockport, Ward 4: :Sweet, Hannah (1835–1919)" \f "Place" }^[439]
Marital Status: Married; Relation to Head of House: Wife
- Residence: 1st June 1915 Ward 8{ XE "USA, New York, Niagara, Lockport, Ward 8: :Sweet, Hannah (1835–1919)" \f "Place" }^[447]
Relation to Head of House: Head

Children of Isaac Sears and Hannah Sweet:

- f I. **Ann Eliza⁷ Sears**{ XE "Sears:Ann Eliza (1857–1892)" \f "Name" \b } was born in New York{ XE "USA, New York:(42.7531° N, 74.2224° W):Sears, Ann Eliza (1857–1892)" \f "Place" } on 16th June 1857.^[440, 444] She died on 13th November 1892, at the age of 35.

More facts and events for Ann Eliza Sears:

- Residence: 1st June 1875 Newfane{ XE "USA, New York, Niagara, Newfane:(43.2867° N, 78.7103° W):Sears, Ann Eliza (1857–1892)" \f "Place" }^[440]
Relation to Head: Daughter
- Residence: 1880 Newfane{ XE "USA, New York, Niagara, Newfane:(43.2867° N, 78.7103° W):Sears, Ann Eliza (1857–1892)" \f "Place" }^[444]
Marital status: Single; Relation to Head of House: Daughter

Ann Eliza married **William Clark**{ XE "Clark:William" \f "Name" \b \i }. They had two sons: Horace (1891–1929) and William (1892–1966).

William was born in Clarkson, Monroe{ XE "USA, New York, Monroe, Clarkson:(43.2331° N, 77.9278° W):Clark, William" \f "Place" }.

of Clarkson,NY

- f II. **Marietta Etta Sears**{ XE "Sears:Marietta \"Etta\" (1859–1932)" \f "Name" \b } was born in New York{ XE "USA, New York:(42.7531° N, 74.2224° W):Sears, Marietta \"Etta\" (1859–1932)" \f "Place" } on 18th May 1859.^[440, 444] She died on 28th April 1932, at the age of 72. Etta was buried. Wright's Corner Cemetery.

More facts and events for Marietta Etta Sears:

- Residence: 1st June 1875 Newfane{ XE "USA, New York, Niagara, Newfane:(43.2867° N, 78.7103° W):Sears, Marietta \"Etta\" (1859–1932)" \f "Place" }

}^[440]

Relation to Head: Daughter

Residence: 1880

Newfane{ XE "USA, New York, Niagara, Newfane:(43.2867° N, 78.7103° W):Sears, Marietta \"Etta\" (1859–1932)" \f "Place" }^[444]

Marital status: Single; Relation to Head of House: Daughter

Marietta Etta Sears married **Alexander Alex McClellan**{ XE "McClellan:Alexander \"Alex\" (-1947)" \f "Name" \b \i } on Wednesday, 10th January 1883. Sears's Homestead, Fuller Rd by Rev Ward B Pickard. They had three children: Gertrude (1885–1955), Morton (1887–) and Marietta (1899–).

Alex died on 12th June 1947. He was buried. Wright's Corner Cemetery. of Wilson,NY

- m III. **Heman Sears**{ XE "Sears:Heman (1861–1885)" \f "Name" \b } was born in New York{ XE "USA, New York:(42.7531° N, 74.2224° W):Sears, Heman (1861–1885)" \f "Place" } on 6th July 1861.^[440, 444] He died on 30th August 1885, at the age of 24.

More facts and events for Heman Sears:

Residence: 1st June 1875

Newfane{ XE "USA, New York, Niagara, Newfane:(43.2867° N, 78.7103° W):Sears, Heman (1861–1885)" \f "Place" }^[440]
Relation to Head: Son

Residence: 1880

Newfane{ XE "USA, New York, Niagara, Newfane:(43.2867° N, 78.7103° W):Sears, Heman (1861–1885)" \f "Place" }^[444]
Marital status: Single; Relation to Head of House: Son

- f IV. **Jennie H Sears**{ XE "Sears:Jennie H (1864–1920)" \f "Name" \b } was born in New York{ XE "USA, New York:(42.7531° N, 74.2224° W):Sears, Jennie H (1864–1920)" \f "Place" } in 1864.^[440, 442, 444] She died in 1920 at the age of 56.^[442] Jennie H was buried in Newfane{ XE "USA, New York, Niagara, Newfane:(43.2867° N, 78.7103° W):Sears, Jennie H (1864–1920)" \f "Place" }.^[442]

More facts and events for Jennie H Sears:

Residence: 1st June 1875

Newfane{ XE "USA, New York, Niagara, Newfane:(43.2867° N, 78.7103° W):Sears, Jennie H (1864–1920)" \f "Place" }^[440]
Relation to Head: Daughter

Residence: 1880

Newfane{ XE "USA, New York, Niagara, Newfane:(43.2867° N, 78.7103° W):Sears, Jennie H (1864–1920)" \f "Place" }^[444]
Marital status: Single; Relation to Head of House: Daughter

Jennie H married **Charles Anderson**{ XE "Anderson:Charles" \f "Name" \b \i } on Friday, 25th January 1884. They had two children: Florence (1885–1905) and Frank (1889–1971).

m

V. **John Sylvester Sears**{ XE "Sears:John Sylvester (1867–1958)" \f "Name" \b } was born in New York{ XE "USA, New York:(42.7531° N, 74.2224° W):Sears, John Sylvester (1867–1958)" \f "Place" } on 21st March 1867.^[440, 442, 444, 446, 448, 449] He died on 24th March 1958, at the age of 91.^[442] John Sylvester was buried in Aurora, Kane County{ XE "USA, Illinois, Kane County, Aurora:(41.7484° N, 88.241° W):Sears, John Sylvester (1867–1958)" \f "Place" }.^[442]



John

More facts and events for John Sylvester Sears:

Residence: 1st June 1875 Newfane, Niagara, New York{ XE "USA, New York, Niagara, Newfane:(43.2867° N, 78.7103° W):Sears, John Sylvester (1867–1958)" \f "Place" }^[440]
 Relation to Head: Son

Residence: 1880 Newfane{ XE "USA, New York, Niagara, Newfane:(43.2867° N, 78.7103° W):Sears, John Sylvester (1867–1958)" \f "Place" }^[444]
 Marital status: Single; Relation to Head of House: Son

Residence: 1900 Ward 3, Aurora, Kane, Illinois{ XE "USA, Illinois, Kane, Aurora, Ward 3: :Sears, John Sylvester (1867–1958)" \f "Place" }^[448]
 Marital Status: Married; Relation to Head: Head

Residence: 1920 Ward 4{ XE "USA, Illinois, Kane, Aurora, Ward 4: :Sears, John Sylvester (1867–1958)" \f "Place" }^[449]
 Relation to Head: Head; Residence Marital Status: Married

John Sylvester married **Edith M Crane**{ XE "Crane:Edith M (1874–1927)" \f "Name" \b \i } in 1900.^[442, 448, 449] They had one daughter: Winifred (ca.1906–).

Edith M was born in Illinois{ XE "USA, Illinois:(39.7333° N, 88.5° W):Crane, Edith M (1874–1927)" \f "Place" } in August 1874.^[442, 448, 449] She was the daughter of Celinda Melissa --Crane{ XE "--Crane:Celinda Melissa (1846–1908)" \f "Name" \i } and Edgar Galloway Crane{ XE "Crane:Edgar Galloway (1837–1922)" \f "Name" \i }.

Edith M reached 52 years of age and died in 1927.^[442] She was buried in Aurora{ XE "USA, Illinois, Kane, Aurora:(41.7484° N, 88.241° W):Crane, Edith M (1874–1927)" \f "Place" }.^[442]

m

VI. **Burt Sears**{ XE "Sears:Burt (1869–1952)" \f "Name" \b } was born in New York{ XE "USA, New York:(42.7531° N, 74.2224° W):Sears, Burt (1869–1952)" \f "Place" } in 1869.^[440, 442, 444, 450, 451] He died in Lockport{ XE "USA, New York, Niagara, Lockport:(43.1706° N, 78.6903° W):Sears, Burt (1869–1952)" \f "Place" } in 1952 at the age of 83.^[442] Burt was buried in Newfane{ XE "USA, New York, Niagara, Newfane:(43.2867° N, 78.7103° W):Sears, Burt (1869–1952)" \f "Place" }.^[442]



Burt

⁴⁴⁸ Ancestry.com, 1900 United States Federal Census (Provo, UT, USA, Ancestry.com Operations Inc, 2004), Ancestry.com, Year: 1900; Census Place: Aurora Ward 3, Kane, Illinois; Roll: 310; Page: 6B; Enumeration District: 0067; FHL microfilm: 1240310.

⁴⁴⁹ Ancestry.com, 1920 United States Federal Census (Provo, UT, USA, Ancestry.com Operations Inc, 2010), Ancestry.com, Year: 1920; Census Place: Aurora Ward 4, Kane, Illinois; Roll: T625_374; Page: 8B; Enumeration District: 46.

⁴⁵⁰ Ancestry.com, 1910 United States Federal Census (Provo, UT, USA, Ancestry.com Operations Inc, 2006), Ancestry.com, Year: 1910; Census Place: Newfane, Niagara, New York; Roll: T624_1049; Page: 5A; Enumeration District: 0093; FHL microfilm: 1375062.

More facts and events for Burt Sears:

- Residence: 1st June 1875 Newfane{ XE "USA, New York, Niagara, Newfane:(43.2867° N, 78.7103° W):Sears, Burt (1869–1952)" \f "Place" }^[440]
Relation to Head: Son
- Residence: 1880 Newfane{ XE "USA, New York, Niagara, Newfane:(43.2867° N, 78.7103° W):Sears, Burt (1869–1952)" \f "Place" }^[444]
Marital status: Single; Relation to Head of House: Son
- Residence: 1910 Newfane{ XE "USA, New York, Niagara, Newfane:(43.2867° N, 78.7103° W):Sears, Burt (1869–1952)" \f "Place" }^[450]
Marital Status: Married; Relation to Head of House: Head
- Residence: 1935 Newfane{ XE "USA, New York, Niagara, Newfane:(43.2867° N, 78.7103° W):Sears, Burt (1869–1952)" \f "Place" }^[451]
- Residence: 1st April 1940 Newfane{ XE "USA, New York, Niagara, Newfane:(43.2867° N, 78.7103° W):Sears, Burt (1869–1952)" \f "Place" }^[451]
Marital Status: Married; Relation to Head of House: Head

Burt Sears married **Rosa M Brandt**{ XE "Brandt:Rosa M (1872–1948)" \f "Name" \b \i }^[442, 450, 451] They had two children: Herbert (1892–1955) and Hazel (1895–1928).

Rosa M was born in New York{ XE "USA, New York:(42.7531° N, 74.2224° W):Brandt, Rosa M (1872–1948)" \f "Place" } in 1872.^[442, 450, 451] She reached 76 years of age and died in 1948.^[442]

Rosa M was buried in Newfane{ XE "USA, New York, Niagara, Newfane:(43.2867° N, 78.7103° W):Brandt, Rosa M (1872–1948)" \f "Place" }^[442].

- f VII. **Caroline Carrie Sears**{ XE "Sears:Caroline \"Carrie\" (1872–1951)" \f "Name" \b } was born in New York{ XE "USA, New York:(42.7531° N, 74.2224° W):Sears, Caroline \"Carrie\" (1872–1951)" \f "Place" } in November 1872.^[439, 441–445, 447, 452, 453–454] She died in 1951 at the age of 78.^[442] Carrie was buried.^[442] Wright's Corner Cemetery.

More facts and events for Caroline Carrie Sears:

- Residence: 1st June 1875 Newfane{ XE "USA, New York, Niagara, Newfane:(43.2867° N, 78.7103° W):Sears, Caroline \"Carrie\" (1872–1951)" \f "Place" }
Relation to Head: Daughter
- Residence: 1880 Newfane{ XE "USA, New York, Niagara, Newfane:(43.2867° N, 78.7103° W):Sears, Caroline \"Carrie\" (1872–1951)" \f "Place" }

⁴⁵¹ Ancestry.com, 1940 United States Federal Census (Provo, UT, USA, Ancestry.com Operations, Inc., 2012), Ancestry.com, Year: 1940; Census Place: Newfane, Niagara, New York; Roll: T627_2696; Page: 13B; Enumeration District: 32-46.

⁴⁵² Ancestry.com, New York, State Census, 1925 (Provo, UT, USA, Ancestry.com Operations, Inc., 2012), Ancestry.com, New York State Archives; Albany, New York; State Population Census Schedules, 1925; Election District: 01; Assembly District: 01; City: Lockport Ward 05; County: Niagara; Page: 7.

⁴⁵³ Ancestry.com, 1930 United States Federal Census (Provo, UT, USA, Ancestry.com Operations Inc, 2002), Ancestry.com, Year: 1930; Census Place: Hartland, Niagara, New York; Roll: 1617; Page: 7B; Enumeration District: 0004; FHL microfilm: 2341351.

⁴⁵⁴ Ancestry.com, 1940 United States Federal Census (Provo, UT, USA, Ancestry.com Operations, Inc., 2012), Ancestry.com, Year: 1940; Census Place: Hartland, Niagara, New York; Roll: T627_2695; Page: 5A; Enumeration District: 32-7.

- Residence: 1900 }^[444]
 Marital status: Single; Relation to Head of House: Daughter
 Newfane{ XE "USA, New York, Niagara, Newfane:(43.2867° N, 78.7103° W):Sears, Caroline \"Carrie\" (1872-1951)" \f "Place" }^[441]
 Marital Status: Single; Relation to Head: Daughter
- Residence: 1905 Newfane{ XE "USA, New York, Niagara, Newfane:(43.2867° N, 78.7103° W):Sears, Caroline \"Carrie\" (1872-1951)" \f "Place" }^[443]
 Relationship to Head: Daughter
- Residence: 1910 Ward 4, Lockport{ XE "USA, New York, Niagara, Lockport, Ward 4: :Sears, Caroline \"Carrie\" (1872-1951)" \f "Place" }^[439]
 Marital Status: Single; Relation to Head of House: Daughter
- Residence: 1st June 1915 Ward 8{ XE "USA, New York, Niagara, Lockport, Ward 8: :Sears, Caroline \"Carrie\" (1872-1951)" \f "Place" }^[447]
 Relation to Head of House: Daughter
- Residence: 1st June 1925 Ward 5{ XE "USA, New York, Niagara, Lockport, Ward 5: :Sears, Caroline \"Carrie\" (1872-1951)" \f "Place" }^[452]
 Relation to Head: Wife
- Residence: 1930 Hartland{ XE "USA, New York, Niagara, Hartland:(43.24° N, 78.5764° W):Sears, Caroline \"Carrie\" (1872-1951)" \f "Place" }^[453]
 Marital Status: Married; Relation to Head: Wife
- Residence: 1935 Hartland{ XE "USA, New York, Niagara, Hartland:(43.24° N, 78.5764° W):Sears, Caroline \"Carrie\" (1872-1951)" \f "Place" }^[454]
- Residence: 1st April 1940 Hartland{ XE "USA, New York, Niagara, Hartland:(43.24° N, 78.5764° W):Sears, Caroline \"Carrie\" (1872-1951)" \f "Place" }^[454]
 Marital Status: Married; Relation to Head of House: Wife

Caroline Carrie Sears married **Elsworth William Brown**{ XE "Brown:Elsworth William (ca.1871-)" \f "Name" \b \i } on Wednesday, 27th April 1921, in Niagara{ XE "USA, New York, Niagara:(43.3239° N, 78.7939° W):Sears, Caroline \"Carrie\" (1872-1951)" \f "Place" }^[445, 452-454] They had two children: Lolis (ca.1901-) and Stewart.

Elsworth William was born in USA{ XE "USA: :Brown, Elsworth William (ca.1871-)" \f "Place" }^[445, 452-454] about 1871.

- f VIII. **Evaline Eva Sears**{ XE "Sears:Evaline \"Eva\" (1873-1949)" \f "Name" \b } was born in New York{ XE "USA, New York:(42.7531° N, 74.2224° W):Sears, Evaline \"Eva\" (1873-1949)" \f "Place" } in 1873.^[440, 442, 444] She died on 4th July 1949, at the age of 76.^[442] Eva was buried in Newfane{ XE "USA, New York, Niagara, Newfane:(43.2867° N, 78.7103° W):Sears, Evaline \"Eva\" (1873-1949)" \f "Place" }^[442]

More facts and events for Evaline Eva Sears:

Residence: 1st June 1875 Newfane{ XE "USA, New York, Niagara, Newfane:(43.2867° N, 78.7103° W):Sears, Evaline \"Eva\" (1873–1949)" \f "Place" }^[440]
 Relation to Head: Daughter

Residence: 1880 Newfane{ XE "USA, New York, Niagara, Newfane:(43.2867° N, 78.7103° W):Sears, Evaline \"Eva\" (1873–1949)" \f "Place" }^[444]
 Marital status: Single; Relation to Head of House: Daughter

Evaline Eva Sears married **Denniston L Wood**{ XE "Wood:Denniston L (1870–1957)" \f "Name" \b \i }. They had three children: Ruth, George (1904–) and Alice (1909–).

Denniston L was born in 1870. He reached 87 years of age and died in 1957.

Cleary: He was a good farmer and had fine stock and orchards.

- m IX. **Wilson Willie Sears**{ XE "Sears:Wilson \"Willie\" (1876–1928)" \f "Name" \b } was born in New York{ XE "USA, New York:(42.7531° N, 74.2224° W):Sears, Wilson \"Willie\" (1876–1928)" \f "Place" } in February 1876.^[441, 442, 444, 455, 456–457] He died in Newfane{ XE "USA, New York, Niagara, Newfane:(43.2867° N, 78.7103° W):Sears, Wilson \"Willie\" (1876–1928)" \f "Place" } in 1928 at the age of 51.^[442] Willie was buried in Corwin Cemetery, Newfane{ XE "USA, New York, Niagara, Newfane, Corwin Cemetery: :Sears, Wilson \"Willie\" (1876–1928)" \f "Place" }.^[442]

More facts and events for Wilson Willie Sears:

Residence: 1880 Newfane{ XE "USA, New York, Niagara, Newfane:(43.2867° N, 78.7103° W):Sears, Wilson \"Willie\" (1876–1928)" \f "Place" }^[444]
 Marital status: Single; Relation to Head of House: Son

Residence: 1900 Newfane{ XE "USA, New York, Niagara, Newfane:(43.2867° N, 78.7103° W):Sears, Wilson \"Willie\" (1876–1928)" \f "Place" }^[441]
 Marital Status: Single; Relation to Head: Son

Residence: 1905 Newfane{ XE "USA, New York, Niagara, Newfane:(43.2867° N, 78.7103° W):Sears, Wilson \"Willie\" (1876–1928)" \f "Place" }^[455]
 Relationship to Head: Son

Residence: 1st June 1915 Newfane{ XE "USA, New York, Niagara, Newfane:(43.2867° N, 78.7103° W):Sears, Wilson \"Willie\" (1876–1928)" \f "Place"

⁴⁵⁵ Ancestry.com, New York, State Census, 1905 (Provo, UT, USA, Ancestry.com Operations, Inc., 2014), Ancestry.com, New York State Archives; Albany, New York; State Population Census Schedules, 1905; Election District: A.D. 02 E.D. 02; City: Newfane; County: Niagara.

⁴⁵⁶ Ancestry.com, New York, State Census, 1915 (Provo, UT, USA, Ancestry.com Operations, Inc., 2012), Ancestry.com, New York State Archives; Albany, New York; State Population Census Schedules, 1915; Election District: 02; Assembly District: 02; City: Newfane; County: Niagara; Page: 07.

⁴⁵⁷ Ancestry.com, New York, State Census, 1925 (Provo, UT, USA, Ancestry.com Operations, Inc., 2012), Ancestry.com, New York State Archives; Albany, New York; State Population Census Schedules, 1925; Election District: 01; Assembly District: 02; City: Newfane; County: Niagara; Page: 15.

Residence: 1st June 1925

}[⁴⁵⁶
Relation to Head of House: Head
Newfane{ XE "USA, New York, Niagara,
Newfane:(43.2867° N, 78.7103° W):Sears,
Wilson \"Willie\" (1876–1928)" \f "Place"
}[⁴⁵⁷
Relation to Head: Head

Wilson Willie Sears married **Ina L Mandaville**{ XE "Mandaville:Ina L (ca.1880–1947)" \f "Name" \b \i }.^[442, 456–458] They had one son: Loren (1909–1990).

Ina L was born in USA{ XE "USA: :Mandaville, Ina L (ca.1880–1947)" \f "Place" } about 1880.^[442, 456–458] She was the daughter of Marcus A Manderville{ XE "Manderville:Marcus A (1841–1916)" \f "Name" \i } and Loiza --Manderville{ XE "--Manderville:Loiza (1846–1914)" \f "Name" \i }.

Ina L reached 67 years of age and died in Newfane{ XE "USA, New York, Niagara, Newfane:(43.2867° N, 78.7103° W):Mandaville, Ina L (ca.1880–1947)" \f "Place" } on 16th August 1947.^[442] She was buried in Newfane{ XE "USA, New York, Niagara, Newfane:(43.2867° N, 78.7103° W):Mandaville, Ina L (ca.1880–1947)" \f "Place" }.^[442]

m X. **Frank Sears**{ XE "Sears:Frank (1878–1971)" \f "Name" \b } was born in Newfane, Niagara, New York,{ XE "USA, New York, Niagara, Newfane:(43.2867° N, 78.7103° W):Sears, Frank (1878–1971)" \f "Place" } on 9th February 1878.^[442–444, 459–460] He died on 4th September 1971, at the age of 93.^[442] Frank was buried.^[442] Wright's Corners Cemetery, 3927.



Frank

More facts and events for Frank Sears:

Residence: 1880

Newfane, Niagara{ XE "USA, New York, Niagara, Newfane:(43.2867° N, 78.7103° W):Sears, Frank (1878–1971)" \f "Place" }^[444]
Marital status: Single; Relation to Head of House: Son

Residence: 1905

Newfane{ XE "USA, New York, Niagara, Newfane:(43.2867° N, 78.7103° W):Sears, Frank (1878–1971)" \f "Place" }^[443]
Relationship to Head: Son

Residence: 1st June 1915

Eden, Erie{ XE "USA, New York, Erie, Eden:(42.6523° N, 78.897° W):Sears, Frank (1878–1971)" \f "Place" }^[459]
Relation to Head of House: Head

Residence:

Erie{ XE "USA, New York, Erie:(42.755° N, 78.7849° W):Sears, Frank (1878–1971)" \f "Place" }^[460]
Relative Relation to Head: Wife

⁴⁵⁸ Ancestry.com, 1900 United States Federal Census (Provo, UT, USA, Ancestry.com Operations Inc, 2004), Ancestry.com, Year: 1900; Census Place: Newfane, Niagara, New York; Roll: 1129; Page: 16B; Enumeration District: 0067; FHL microfilm: 1241129.
[Source citation includes one media item]

⁴⁵⁹ Ancestry.com, New York, State Census, 1915 (Provo, UT, USA, Ancestry.com Operations, Inc., 2012), Ancestry.com, New York State Archives; Albany, New York; State Population Census Schedules, 1915; Election District: 02; Assembly District: 09; City: Eden; County: Erie; Page: 13.

⁴⁶⁰ Ancestry.com, U.S., World War I Draft Registration Cards, 1917–1918 (Provo, UT, USA, Ancestry.com Operations Inc, 2005), Ancestry.com, Registration State: New York; Registration County: Erie; Roll: 1712369; Draft Board: 2.

Frank Sears married **Anna Mary Siemdorf**{ XE "Siemdorf:Anna Mary (ca.1882–1959)" \f "Name" \b \i } on Wednesday, 30th June 1909, in Lockport, Niagara{ XE "USA, New York, Niagara, Lockport:(43.1706° N, 78.6903° W):Sears, Frank (1878–1971)" \f "Place" \b \i }.^[442, 459] They had no known children.

Anna Mary was born in USA{ XE "USA: :Siemdorf, Anna Mary (ca.1882–1959)" \f "Place" \b \i } about 1882.^[442, 459] She reached 77 years of age and died on 4th March 1959.^[442] Anna Mary was buried in Newfane, Niagara{ XE "USA, New York, Niagara, Newfane:(43.2867° N, 78.7103° W):Siemdorf, Anna Mary (ca.1882–1959)" \f "Place" \b \i }.^[442]

Family of Mary Sears and James Christy{ TC "Mary Sears and James Christy" \I 3 \f C}

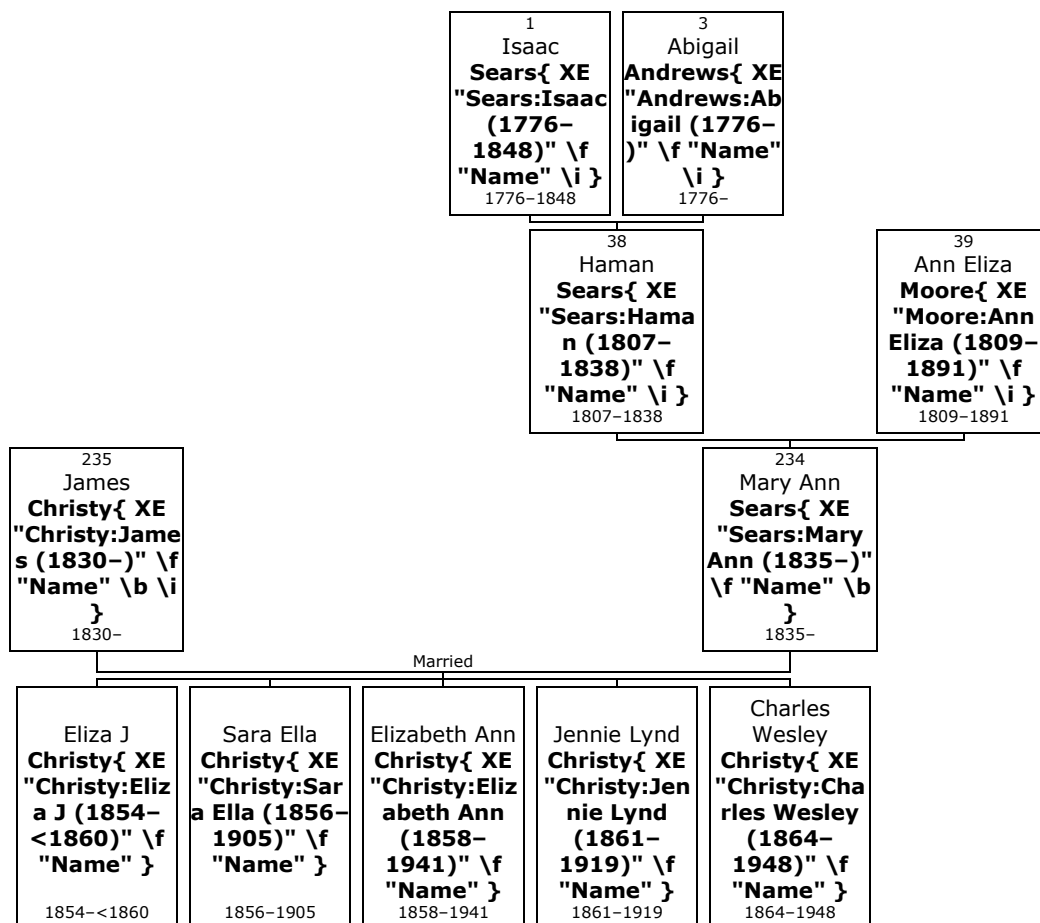

234. Mary Ann⁶ Sears{ XE "Sears:Mary Ann (1835-)" \f "Name" \b } (*Haman⁵, Isaac⁴, Susanna³ Townsend*) was born in 1835 in perh, Newfane, Niagara, New York, USA{ XE "USA, New York, Niagara, Newfane, perh: :Sears, Mary Ann (1835-)" \f "Place" \b \i }.^[461, 462, 463, 464-465] She was the daughter of Haman Sears{ XE

⁴⁶¹ FamilySearch.org, FamilySearch Family Tree, FamilySearch, "Family Tree," database, <i>FamilySearch</i> (<http://familysearch.org> : modified 02 August 2018, 21:54), entry for Mary Ann Sears(PID <https://familysearch.org/ark:/61903/4:1:LVZ4-7LR>); contributed by various users. PersonID LVZ4-7LR. Mary Ann Sears. <https://familysearch.org/ark:/61903/4:1:LVZ4-7LR>.

⁴⁶² FamilySearch.org, FamilySearch Family Tree, FamilySearch, Source Citation Probate Records, [Niagara County, New York] 1820-1906 (Approx.); Author: New York. Surrogate's Court (Niagara County); Probate Place: Niagara, New York Source Information Ancestry.com. New York, Wills and Probate Records, 165. Mary Ann Sears in the New York, Wills and Probate Records, 1659-1999 for grandfather, Isaa Sears:.

⁴⁶³ FamilySearch.org, FamilySearch Family Tree, FamilySearch, Source Citation Probate Records, [Niagara County, New York] 1820-1906 (Approx.); Author: New York. Surrogate's Court (Niagara County); Probate Place: Niagara, New York Source Information Ancestry.com. New York, Wills and Probate Records, 165. Mary Ann Sears in the New York, Wills and Probate Records, 1659-1999 for father, Haman Sears. https://www.ancestry.com/interactive/8800/005116436_00235?pid=2719508&backurl=http://search.ancestry.com/cgi-bin/sse.dll?indiv%3D1%26dbid%3D8800%26h%3D2719508%26ssrc%3Dpt%26tid%3D17384233%26pid%3D43011296794%26usePUB%3Dtrue&ssrc=pt&treedid=17384233&personid=430112967946&hintid=&usePUB=true&usePUBJs=true.

"Sears:Haman (1807–1838)" \f "Name" \i } (38) and Ann Eliza Moore{ XE "Moore:Ann Eliza (1809–1891)" \f "Name" \i } (39).

Mary Ann was buried in Olcott{ XE "USA, New York, Niagara, Olcott:(43.3378° N, 78.7148° W):Sears, Mary Ann (1835–)" \f "Place" }.
 Still need to prove that she is the daughter of Haman. Deborah Cleary has a document compiled by S.P. May 1870 (1890?) which shows some additional info.

More facts and events for Mary Ann Sears:

Residence: 1860 Newfane{ XE "USA, New York, Niagara, Newfane:(43.2867° N, 78.7103° W):Sears, Mary Ann (1835–)" \f "Place" }^[461]

Residence: 1860 Newfane{ XE "USA, New York, Niagara, Newfane:(43.2867° N, 78.7103° W):Sears, Mary Ann (1835–)" \f "Place" }

- 235.** She married **James Christy**{ XE "Christy:James (1830–)" \f "Name" \b \i }. They had five children: Eliza (1854–<1860), Sara (1856–1905), Elizabeth (1858–1941), Jennie (1861–1919) and Charles (1864–1948).

James was born in New York{ XE "USA, New York:(42.7531° N, 74.2224° W):Christy, James (1830–)" \f "Place" } in 1830. He worked as a Farmer.

More facts and events for James Christy:

Residence: 1860 Newfane{ XE "USA, New York, Niagara, Newfane:(43.2867° N, 78.7103° W):Christy, James (1830–)" \f "Place" }

Residence: 1860 Newfane{ XE "USA, New York, Niagara, Newfane:(43.2867° N, 78.7103° W):Christy, James (1830–)" \f "Place" }

Residence: 1870 New York{ XE "USA, New York:(42.7531° N, 74.2224° W):Christy, James (1830–)" \f "Place" }

Residence: 1870 New York{ XE "USA, New York:(42.7531° N, 74.2224° W):Christy, James (1830–)" \f "Place" }

Residence: 1880 Newfane, Niagara, New York{ XE "USA, New York, Niagara, Newfane:(43.2867° N, 78.7103° W):Christy, James (1830–)" \f "Place" }

Residence: 1880 Newfane{ XE "USA, New York, Niagara, Newfane:(43.2867° N, 78.7103° W):Christy, James (1830–)" \f "Place" }

Children of Mary Ann Sears and James Christy:

- f I. **Eliza J⁷ Christy**{ XE "Christy:Eliza J (1854–<1860)" \f "Name" \b } was born in Newfane{ XE "USA, New York, Niagara, Newfane:(43.2867° N, 78.7103° W):Christy, Eliza J (1854–<1860)" \f "Place" } in 1854. She died in Newfane{ XE "USA, New York, Niagara, Newfane:(43.2867° N, 78.7103° W):Christy, Eliza J (1854–<1860)" \f "Place" } before 1860.
- f II. **Sara Ella Christy**{ XE "Christy:Sara Ella (1856–1905)" \f "Name" \b } was born on 11th August 1856. She worked as an At Home.
 Sara Ella died on 15th July 1905, at the age of 48.
 More facts and events for Sara Ella Christy:

Residence: 1860 Newfane{ XE "USA, New York, Niagara, Newfane:(43.2867°

⁴⁶⁴ FamilySearch.org, FamilySearch Family Tree, FamilySearch, Source Information Ancestry.com. New York, State Census, 1855 [database on-line]. Provo, UT, USA: Ancestry.com Operations, Inc., 2013. Original data: Census of the state of New York, for 1855. Microfilm. New York State Archives, Albany, New York. James & Mary Ann [Sears] Christie in the New York, State Census, 1855.
https://www.ancestry.com/interactive/7181/005207173_00122/1653993779?backurl=https://www.ancestry.com/family-tree/person/tree/17384233/person/430112968108/facts.

⁴⁶⁵ FamilySearch.org, FamilySearch Family Tree, FamilySearch, "United States Census, 1860", database with images, <i>FamilySearch</i> (https://familysearch.org/ark:/61903/1:1:MCWV-9ZQ : 12 December 2017), Mary A Christy in entry for Jams Chisty, 1860. Mary A Christy in household of Jams Chisty, "United States Census, 1860".
<https://familysearch.org/ark:/61903/1:1:MCWV-9ZQ>.

- N, 78.7103° W):Christy, Sara Ella (1856–1905)" \f "Place" }
 Residence: 1870 New York{ XE "USA, New York:(42.7531° N, 74.2224° W):Christy, Sara Ella (1856–1905)" \f "Place" }
 Residence: 1880 Newfane, Niagara, New York{ XE "USA, New York, Niagara, Newfane:(43.2867° N, 78.7103° W):Christy, Sara Ella (1856–1905)" \f "Place" }
- f III. **Elizabeth Ann Christy**{ XE "Christy:Elizabeth Ann (1858–1941)" \f "Name" \b } was born on 27th September 1858.^[466, 467–468] She died on 19th October 1941, at the age of 83.
 More facts and events for Elizabeth Ann Christy:
- Residence: 1860 Newfane, Niagara, New York{ XE "USA, New York, Niagara, Newfane:(43.2867° N, 78.7103° W):Christy, Elizabeth Ann (1858–1941)" \f "Place" }^[468]
 Residence: 1860 Newfane{ XE "USA, New York, Niagara, Newfane:(43.2867° N, 78.7103° W):Christy, Elizabeth Ann (1858–1941)" \f "Place" }
 Residence: 1870 New York{ XE "USA, New York:(42.7531° N, 74.2224° W):Christy, Elizabeth Ann (1858–1941)" \f "Place" }
 Residence: 1870 New York{ XE "USA, New York:(42.7531° N, 74.2224° W):Christy, Elizabeth Ann (1858–1941)" \f "Place" }^[468]

At the age of 25, Elizabeth Ann married **Lorenzo S Wille**{ XE "Wille:Lorenzo S (1860–1935)" \f "Name" \b \i } on Thursday, 10th January 1884, in Newfane, Niagara, New York,{ XE "USA, New York, Niagara, Newfane:(43.2867° N, 78.7103° W):Christy, Elizabeth Ann (1858–1941)" \f "Place" } when he was 23 years old. They had one son: Frank (1885–1949).

Lorenzo S was born on Saturday, 15th September 1860. He reached 75 years of age and died on 26th September 1935.

- f IV. **Jennie Lynd Christy**{ XE "Christy:Jennie Lynd (1861–1919)" \f "Name" \b } was born on 4th July 1861. She died on 12th December 1919, at the age of 58.
 More facts and events for Jennie Lynd Christy:
- Residence: 1870 New York{ XE "USA, New York:(42.7531° N, 74.2224° W):Christy, Jennie Lynd (1861–1919)" \f "Place" }

At the age of 17, Jennie Lynd Christy married **LaVerne Tuttle**{ XE "Tuttle:LaVerne (1848–1918)" \f "Name" \b \i } on Wednesday, 19th March 1879, in Newfane, Niagara, New York,{ XE "USA, New York, Niagara, Newfane:(43.2867° N, 78.7103° W):Christy, Jennie Lynd (1861–1919)" \f "Place" } when he was 30 years old. They had two children: Dora (1880–) and Roy.

LaVerne was born on Saturday, 17th June 1848. He reached 70 years of age and died on 9th September 1918.

⁴⁶⁶ FamilySearch.org, FamilySearch Family Tree, FamilySearch, "United States Census, 1870," database with images, <i>FamilySearch</i> (https://familysearch.org/ark:/61903/1:1:M8VQ-DPX : 12 April 2016), Elizabeth Christy in household of James Christy, New York, United States; citing p. 76, family 627, NARA microfilm. Elizabeth Christy in household of James Christy, "United States Census, 1870". https://familysearch.org/ark:/61903/1:1:M8VQ-DPX.

⁴⁶⁷ FamilySearch.org, FamilySearch Family Tree, FamilySearch, "United States Census, 1860," database with images, <i>FamilySearch</i> (https://familysearch.org/ark:/61903/1:1:MCWV-9ZW : 12 December 2017), Elizabeth A Chisty in entry for Jams Chisty, 1860. Elizabeth A Chisty in household of Jams Chisty, "United States Census, 1860". https://familysearch.org/ark:/61903/1:1:MCWV-9ZW.

⁴⁶⁸ FamilySearch.org, FamilySearch Family Tree, FamilySearch, "Family Tree," database, <i>FamilySearch</i> (http://familysearch.org : modified 07 November 2018, 00:03), entry for Elizabeth A Christy(PID https://familysearch.org/ark:/61903/4:1:LVZ4-478); contributed by various users. PersonID LVZ4-478. Elizabeth A Christy. https://familysearch.org/ark:/61903/4:1:LVZ4-478.

m

V. **Charles Wesley Christy**{ XE "Christy:Charles Wesley (1864–1948)" \f "Name" \b } was born on 26th March 1864.^[469] He died at Age: 84 in Lockport, Niagara, New York,{ XE "USA, New York, Niagara, Lockport:(43.1706° N, 78.6903° W):Christy, Charles Wesley (1864–1948)" \f "Place" } on 15th August 1948, at the age of 84.^[469]

More facts and events for Charles Wesley Christy:

Residence: 1870 New York{ XE "USA, New York:(42.7531° N, 74.2224° W):Christy, Charles Wesley (1864–1948)" \f "Place" }

At the age of 24, Charles Wesley Christy married **Prudence Emeline Anderson**{ XE "Anderson:Prudence Emeline (1866–1931)" \f "Name" \b \i } on Tuesday, 25th December 1888, when she was 22 years old. They had five children: Bessie (1889–), LaVern (1891–1918), Lorraine (1895–), Charles (1897–1965) and Prudence (1907–).

Prudence Emeline was born on Saturday, 22nd September 1866. She reached 64 years of age and died on 31st January 1931.

Family of Sophia Sears and Ammi Smith{ TC "Sophia Sears and Ammi Smith" \I 3 \f C}

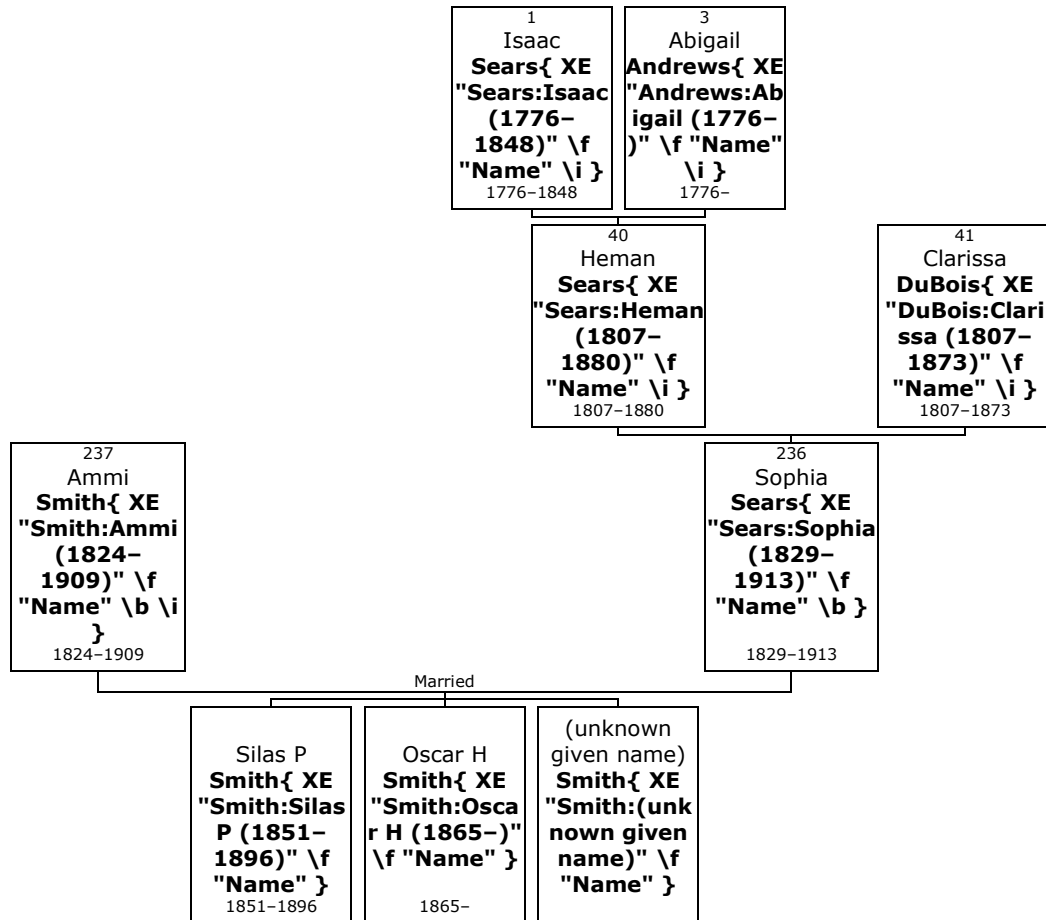

236. Sophia⁶ Sears{ XE "Sears:Sophia (1829–1913)" \f "Name" \b } (*Heman⁵, Isaac⁴, Susanna³ Townsend*) was born on Wednesday, 28th January 1829, in perh, Newfane, Niagara, New York, USA{ XE "USA, New York, Niagara, Newfane, perh: :Sears, Sophia (1829–1913)" \f "Place" }.^[470, 471] She was the daughter of

⁴⁶⁹ Ancestry.com, New York, Death Index, 1880-1956 (Lehi, UT, USA, Ancestry.com Operations, Inc., 2017), New York Department of Health; Albany, NY; NY State Death Index. Record for Charles W Christy. <http://search.ancestry.com/cgi-bin/sse.dll?db=61535&h=240331&indiv=try>.

⁴⁷⁰ Ancestry.com, New York, State Census, 1865 (Provo, UT, USA, Ancestry.com Operations, Inc., 2014), Ancestry.com, Record for Oscar H Smith. <http://search.ancestry.com/cgi-bin/sse.dll?db=7218&h=1558657&indiv=try>. [Source citation includes one media item]

⁴⁷¹ Ancestry.com, U.S., Find A Grave Index, 1600s-Current (Provo, UT, USA, Ancestry.com Operations, Inc., 2012), Ancestry.com.

Heman Sears{ XE "Sears:Heman (1807–1880)" \f "Name" \i } (40) and Clarissa DuBois{ XE "DuBois:Clarissa (1807–1873)" \f "Name" \i } (41).

Sophia died in Newfane{ XE "USA, New York, Niagara, Newfane:(43.2867° N, 78.7103° W):Sears, Sophia (1829–1913)" \f "Place" } on 16th March 1913, at the age of 84.^[471] She was buried in Newfane{ XE "USA, New York, Niagara, Newfane:(43.2867° N, 78.7103° W):Sears, Sophia (1829–1913)" \f "Place" }.^[471]

More facts and events for Sophia Sears:

Residence: 1865 Newfane{ XE "USA, New York, Niagara, Newfane:(43.2867° N, 78.7103° W):Sears, Sophia (1829–1913)" \f "Place" }.^[470]
Age: 36; RelationToHead: Wife

237. She married **Ammi Smith**{ XE "Smith:Ammi (1824–1909)" \f "Name" \b \i }.^[470] They had three children: Silas (1851–1896), Oscar (1865–) and (unknown given name).

Ammi was born in New York{ XE "USA, New York:(42.7531° N, 74.2224° W):Smith, Ammi (1824–1909)" \f "Place" } on Wednesday, 12th May 1824.^[470] He reached 85 years of age and died in North Hartland{ XE "USA, New York, North Hartland: :Smith, Ammi (1824–1909)" \f "Place" } on 9th November 1909. Ammi was buried in Newfane, Niagara{ XE "USA, New York, Niagara, Newfane:(43.2867° N, 78.7103° W):Smith, Ammi (1824–1909)" \f "Place" }.

More facts and events for Ammi Smith:

Residence: 1865 Newfane{ XE "USA, New York, Niagara, Newfane:(43.2867° N, 78.7103° W):Smith, Ammi (1824–1909)" \f "Place" }.^[470]
Age: 40; RelationToHead: Head

Children of Sophia Sears and Ammi Smith:

m I. **Silas P⁷ Smith**{ XE "Smith:Silas P (1851–1896)" \f "Name" \b } was born in Newfane{ XE "USA, New York, Niagara, Newfane:(43.2867° N, 78.7103° W):Smith, Silas P (1851–1896)" \f "Place" } on 16th April 1851.^[472, 473, 474, 475, 476, 477, 478–479] He died in Newfane{ XE "USA, New York, Niagara, Newfane:(43.2867° N, 78.7103° W):Smith, Silas P (1851–1896)" \f "Place" } on 10th June 1896, at the age of 45.^[472, 478] Silas P was buried in Newfane{ XE "USA, New York, Niagara, Newfane:(43.2867° N, 78.7103° W):Smith, Silas P (1851–1896)" \f "Place" }.^[472, 478]

Silas P married **Harriet E Hattie Dutcher**{ XE "Dutcher:Harriet E \"Hattie\" (1857–1882)" \f "Name" \b \i }. They had three children: Sophia (1878–1960), Reuben (1881–1971) and Harriet (1882–1969).

⁴⁷² FamilySearch.org, FamilySearch Family Tree, FamilySearch, "Family Tree," database, <i>FamilySearch</i> (<http://familysearch.org> : modified 27 December 2018, 00:11), entry for Silas P Smith(PID <https://familysearch.org/ark:/61903/4:1:L5T9-HCY>); contributed by various users. PersonID L5T9-HCY. Silas P Smith. <https://familysearch.org/ark:/61903/4:1:L5T9-HCY>.

⁴⁷³ FamilySearch.org, FamilySearch Family Tree, FamilySearch, Year: 1870; Census Place: Newfane, Niagara, New York; Roll: M593_1055; Page: 312B; Image: 323708; Family History Library Film: 552554. 1870 United States Federal Census. <http://search.ancestry.com/cgi-bin/sse.dll?dbid=7163&h=31529296&indiv=try>.

⁴⁷⁴ FamilySearch.org, FamilySearch Family Tree, FamilySearch, Year: 1860; Census Place: Newfane, Niagara, New York; Roll: M653_823; Page: 1235; Image: 661; Family History Library Film: 803823. 1860 United States Federal Census. <http://search.ancestry.com/cgi-bin/sse.dll?dbid=7667&h=47531958&indiv=try>.

⁴⁷⁵ FamilySearch.org, FamilySearch Family Tree, FamilySearch, New York, State Census, 1855. <http://search.ancestry.com/cgi-bin/sse.dll?dbid=7181&h=1653988462&indiv=try>.

⁴⁷⁶ FamilySearch.org, FamilySearch Family Tree, FamilySearch, New York, State Census, 1865. <http://search.ancestry.com/cgi-bin/sse.dll?dbid=7218&h=1558635&indiv=try>.

⁴⁷⁷ FamilySearch.org, FamilySearch Family Tree, FamilySearch, New York, State Census, 1875. <http://search.ancestry.com/cgi-bin/sse.dll?dbid=7250&h=1362546440&indiv=try>.

⁴⁷⁸ FamilySearch.org, FamilySearch Family Tree, FamilySearch, U.S., Find A Grave Index, 1600s-Current. <http://search.ancestry.com/cgi-bin/sse.dll?dbid=60525&h=43725536&indiv=try>.

⁴⁷⁹ FamilySearch.org, FamilySearch Family Tree, FamilySearch, Year: 1880; Census Place: Wilson, Niagara, New York; Roll: 901; Family History Film: 1254901; Page: 409C; Enumeration District: 195; Image: 0399. 1880 United States Federal Census. <http://search.ancestry.com/cgi-bin/sse.dll?dbid=6742&h=3278109&indiv=try>.

Hattie was born in Niagara{ XE "USA, New York, Niagara:(43.3239° N, 78.7939° W):Dutcher, Harriet E \"Hattie\" (1857–1882)" \f "Place" } in 1857. She was also known as **Hattie**{ XE "Dutcher:Hattie (Harriet E.\. Dutcher) (1857–1882)" \f "Name" }.

Hattie reached 25 years of age and died in 1882.

m II. **Oscar H Smith**{ XE "Smith:Oscar H (1865–)" \f "Name" \b } was born in 1865.^[470]

More facts and events for Oscar H Smith:

Residence: 1865 Newfane{ XE "USA, New York, Niagara, Newfane:(43.2867° N, 78.7103° W):Smith, Oscar H (1865–)" \f "Place" }^[470]
Age: 0; RelationToHead: Son

Oscar H married **Lillian Nichols**{ XE "Nichols:Lillian" \f "Name" \b \i }.

III. **(unknown given name) Smith**{ XE "Smith:(unknown given name)" \f "Name" \b }.

Family of Polly Sears and Emory Lewis{ TC "Polly Sears and Emory Lewis" \I 3 \f C}

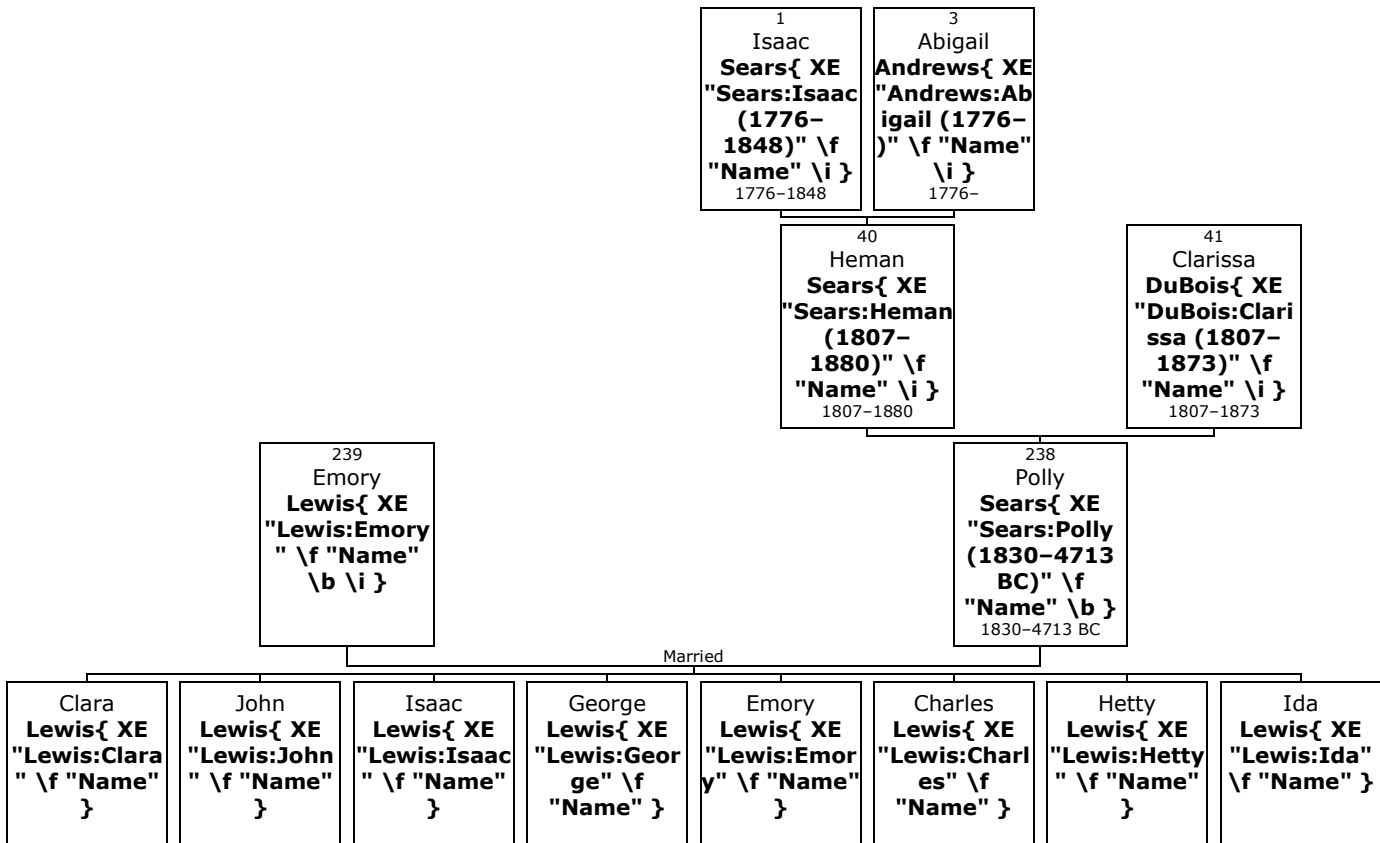

238. Polly⁶ Sears{ XE "Sears:Polly (1830–4713 BC)" \f "Name" \b } (*Heman⁵, Isaac⁴, Susanna³ Townsend*) was born on Friday, 31st December 1830, in perh, Newfane, Niagara, New York, USA{ XE "USA, New York, Niagara, Newfane, perh: :Sears, Polly (1830–4713 BC)" \f "Place" }. She was the daughter of Heman Sears{ XE "Sears:Heman (1807–1880)" \f "Name" \i } (40) and Clarissa DuBois{ XE "DuBois:Clarissa (1807–1873)" \f "Name" \i } (41).

Polly died on 15th April 4713 B.C., at the age of -6544.

239. She married **Emory Lewis**{ XE "Lewis:Emory" \f "Name" \b \i }. They had eight children: Clara, John, Isaac, George, Emory, Charles, Hetty and Ida.

Children of Polly Sears and Emory Lewis:

- f I. **Clara⁷ Lewis**{ XE "Lewis:Clara" \f "Name" \b }.
- m II. **John Lewis**{ XE "Lewis:John" \f "Name" \b }.
- m III. **Isaac Lewis**{ XE "Lewis:Isaac" \f "Name" \b }.

- m IV. **George Lewis**{ XE "Lewis:George" \f "Name" \b }.
 - m V. **Emory Lewis**{ XE "Lewis:Emory" \f "Name" \b }.
 - m VI. **Charles Lewis**{ XE "Lewis:Charles" \f "Name" \b }.
 - f VII. **Hetty Lewis**{ XE "Lewis:Hetty" \f "Name" \b }.
 - f VIII. **Ida Lewis**{ XE "Lewis:Ida" \f "Name" \b }.
- Ida married **Richard Kent**{ XE "Kent:Richard" \f "Name" \b \i }.

Hester Sears{ TC "Hester Sears" \I 3 \f C}

240. Hester Marie⁶ Sears{ XE "Sears:Hester Marie (1836–1918)" \f "Name" \b } (*Heman⁵, Isaac⁴, Susanna³ Townsend*) was born on Tuesday, 1st March 1836, in perh, Newfane, Niagara, New York, USA{ XE "USA, New York, Niagara, Newfane, perh: :Sears, Hester Marie (1836–1918)" \f "Place" }.^[480] She was the daughter of Heman Sears{ XE "Sears:Heman (1807–1880)" \f "Name" \i } (40) and Clarissa DuBois{ XE "DuBois:Clarissa (1807–1873)" \f "Name" \i } (41).

Hester Marie died in Wilson, Niagara County,{ XE "USA, New York, Niagara County, Wilson:(43.3098° N, 78.8262° W):Sears, Hester Marie (1836–1918)" \f "Place" } on 25th February 1918, at the age of 81.^[480] She was buried in Wilson{ XE "USA, New York, Niagara County, Wilson:(43.3098° N, 78.8262° W):Sears, Hester Marie (1836–1918)" \f "Place" }.^[480]

!S.P. May No 2953 p.421 Lives Maple st, Niagra co. NY

!Cleary notes: They lived on the Shaw farm on Maple rd, Wilson, NY. Remains of buildings still standing.
 !1880 United States Federal Census <http://www.ancestry.com/search/db.aspx?dbid=6742> Name: Hester N. Share [Hester N. Shaw] Home in 1880: Wilson, Niagara, New York Age: 44 Estimated birth year: abt 1836 Birthplace: New York Relation to Head of Household: Wife Spouse's name: Charles Father's birthplace: Connecticut Mother's birthplace: New York Occupation: Keeps House Marital Status: Married Race: White Gender: Female

Household Members: Name Age

Charles Share 68
 Hester N. Share 44
 Heman Share 8
 Elsie Share 5
 Kittie Van Wagner 20
 Clara Van Wagner 16
 Henry Anderson 21

Marriages with Morgan van Wagoner and Charles Shaw (Page 289) are known.

⁴⁸⁰ Ancestry.com, U.S., Find A Grave Index, 1600s-Current (Provo, UT, USA, Ancestry.com Operations, Inc., 2012), Ancestry.com.

Family of Hester Sears and Morgan van Wagoner{ TC "Hester Sears and Morgan van Wagoner" \I 4 \f C}

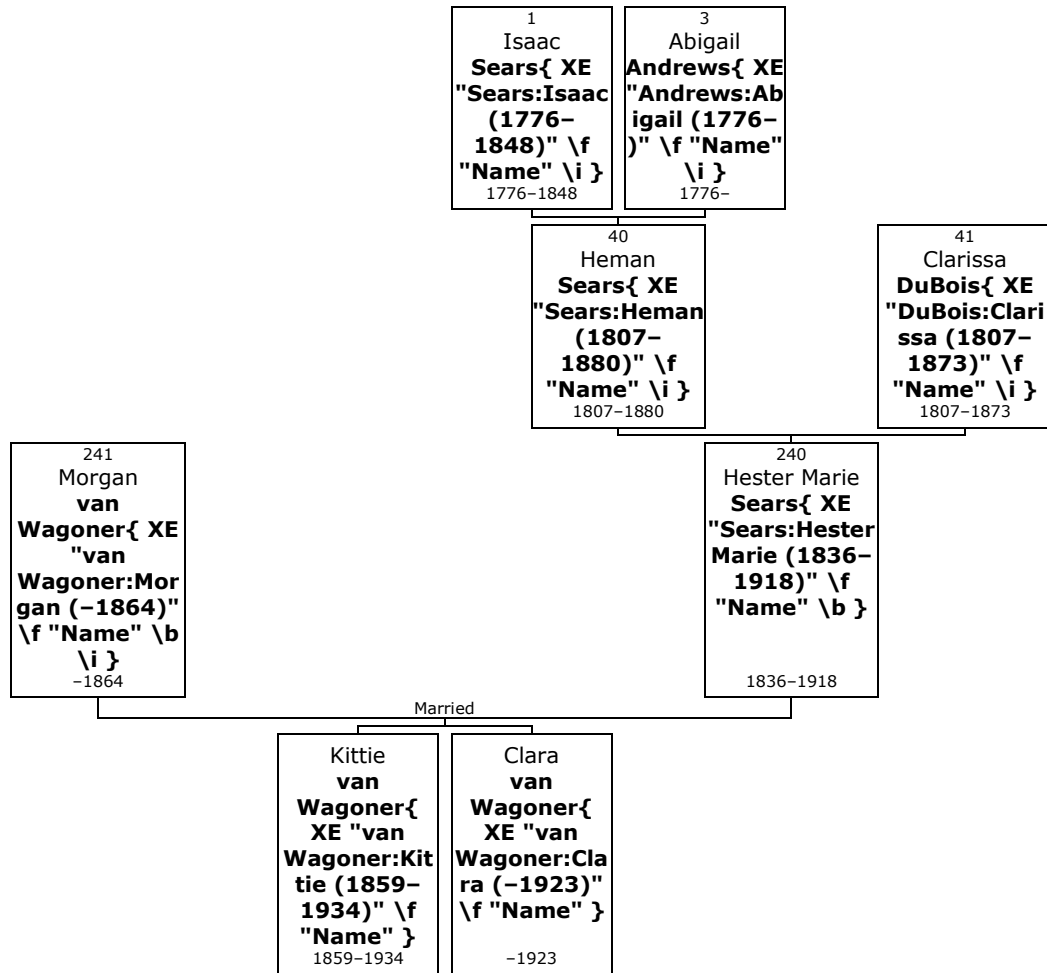

Here are the details about **Hester Marie Sears**{ XE "Sears:Hester Marie (1836-1918)" \f "Name" \b } first marriage, with Morgan van Wagoner. You can read more about Hester Marie on page 287.

- 241.** Hester Marie Sears married **Morgan van Wagoner**{ XE "van Wagoner:Morgan (-1864)" \f "Name" \b \i }. They had two daughters: Kittie (1859-1934) and Clara (-1923).

Morgan died on 12th December 1864.

Daughters of Hester Marie Sears and Morgan van Wagoner:

- f I. **Kittie⁷ van Wagoner**{ XE "van Wagoner:Kittie (1859-1934)" \f "Name" \b } was born on 10th November 1859.^[481] She died on 30th March 1934, at the age of 74.

More facts and events for Kittie van Wagoner:

Residence: 1st June 1915

Wilson{ XE "USA, New York, Niagara, Wilson:(43.3098° N, 78.8262° W):van Wagoner, Kittie (1859-1934)" \f "Place" }^[481]

Age: 56; RelationToHead: Wife

Kittie married **Francis B Frank Farley**{ XE "Farley:Francis B \"Frank\" (1856-1946)" \f "Name" \b \i }.^[481] They had two sons: Ray (1889-) and Leon (-1903).

⁴⁸¹ Ancestry.com, New York, State Census, 1915 (Provo, UT, USA, Ancestry.com Operations, Inc., 2012), Ancestry.com, New York State Archives; Albany, New York; State Population Census Schedules, 1915; Election District: 01; Assembly District: 02; City: Wilson; County: Niagara; Page: 07. Record for Kittie Farley.
<http://search.ancestry.com/cgi-bin/sse.dll?db=2703&h=6241319&indiv=try>.

Frank was born on Friday, 30th May 1856.^[481] He reached 90 years of age and died on 22nd December 1946.

- f II. **Clara van Wagoner**{ XE "van Wagoner:Clara (-1923)" \f "Name" \b }. Clara died on 28th October 1923.

Family of Hester Sears and Charles Shaw{ TC "Hester Sears and Charles Shaw" \I 4 \f C}

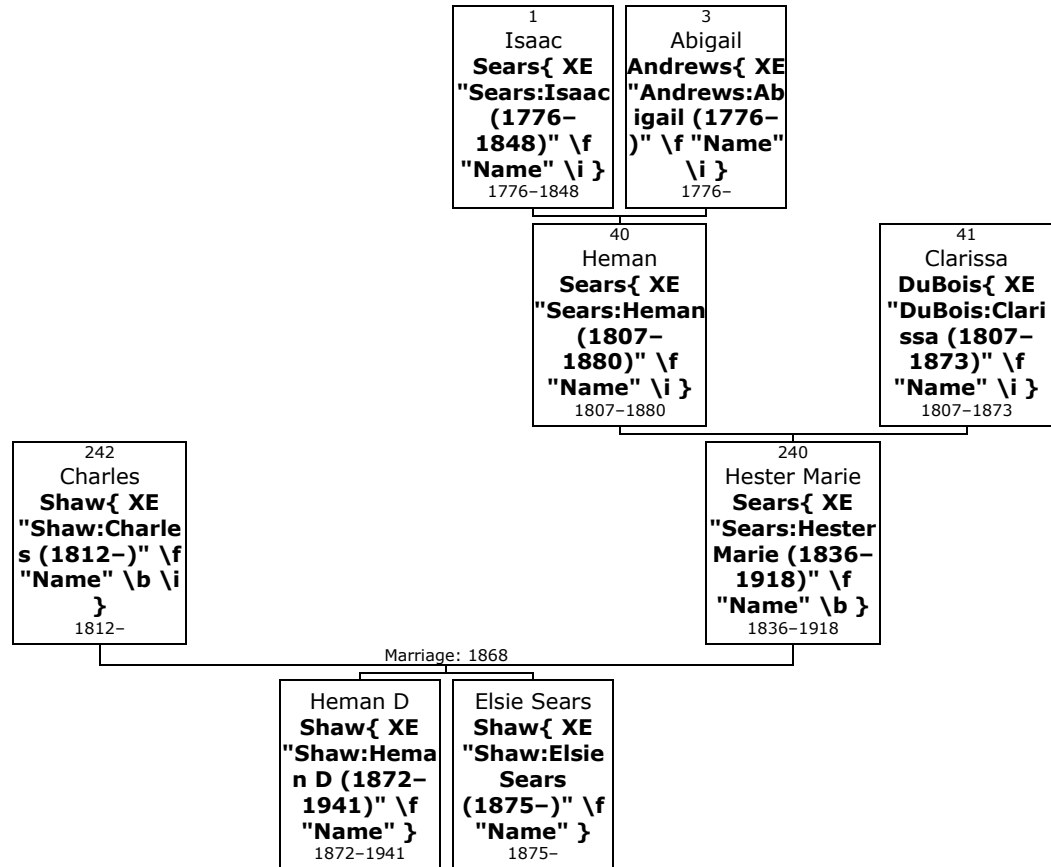

Here are the details about **Hester Marie Sears**{ XE "Sears:Hester Marie (1836-1918)" \f "Name" \b } second marriage, with Charles Shaw. You can read more about Hester Marie on page 287.

- 242.** Hester Marie Sears married **Charles Shaw**{ XE "Shaw:Charles (1812-)" \f "Name" \b \i } on Friday, 6th November 1868. They had two children: Heman (1872-1941) and Elsie (1875-).

Charles was born in New York{ XE "USA, New York:(42.7531° N, 74.2224° W):Shaw, Charles (1812-)" \f "Place" } in 1812.

Children of Hester Marie Sears and Charles Shaw:

- m I. **Heman D⁷ Shaw**{ XE "Shaw:Heman D (1872-1941)" \f "Name" \b } was born in 1872. He died on 2nd July 1941, at the age of 69.

Heman D married **Ida Henning**{ XE "Henning:Ida" \f "Name" \b \i }.

- f II. **Elsie Sears Shaw**{ XE "Shaw:Elsie Sears (1875-)" \f "Name" \b } was born in New York{ XE "USA, New York:(42.7531° N, 74.2224° W):Shaw, Elsie Sears (1875-)" \f "Place" } in 1875.

Elsie Sears married **Henry O Wilson**{ XE "Wilson:Henry O (1875-1963)" \f "Name" \b \i } on Wednesday, 26th February 1902. They had two daughters: Marie (1903-) and Ellene (1905-1959).

Henry O was born in New York{ XE "USA, New York:(42.7531° N, 74.2224° W):Wilson, Henry O (1875-1963)" \f "Place" } in 1875. He reached 88 years of age and died in 1963. Henry O was buried in North Ridge Cemetery, Cambria, Niagara, New York{ XE "USA, New York, Niagara, Cambria, North Ridge Cemetery: :Wilson, Henry O (1875-1963)" \f "Place" }.

father b. NY. mother b. Germany

Family of Haman Sears and Marcena Strong{ TC "Haman Sears and Marcena Strong" \I 3 \f C}

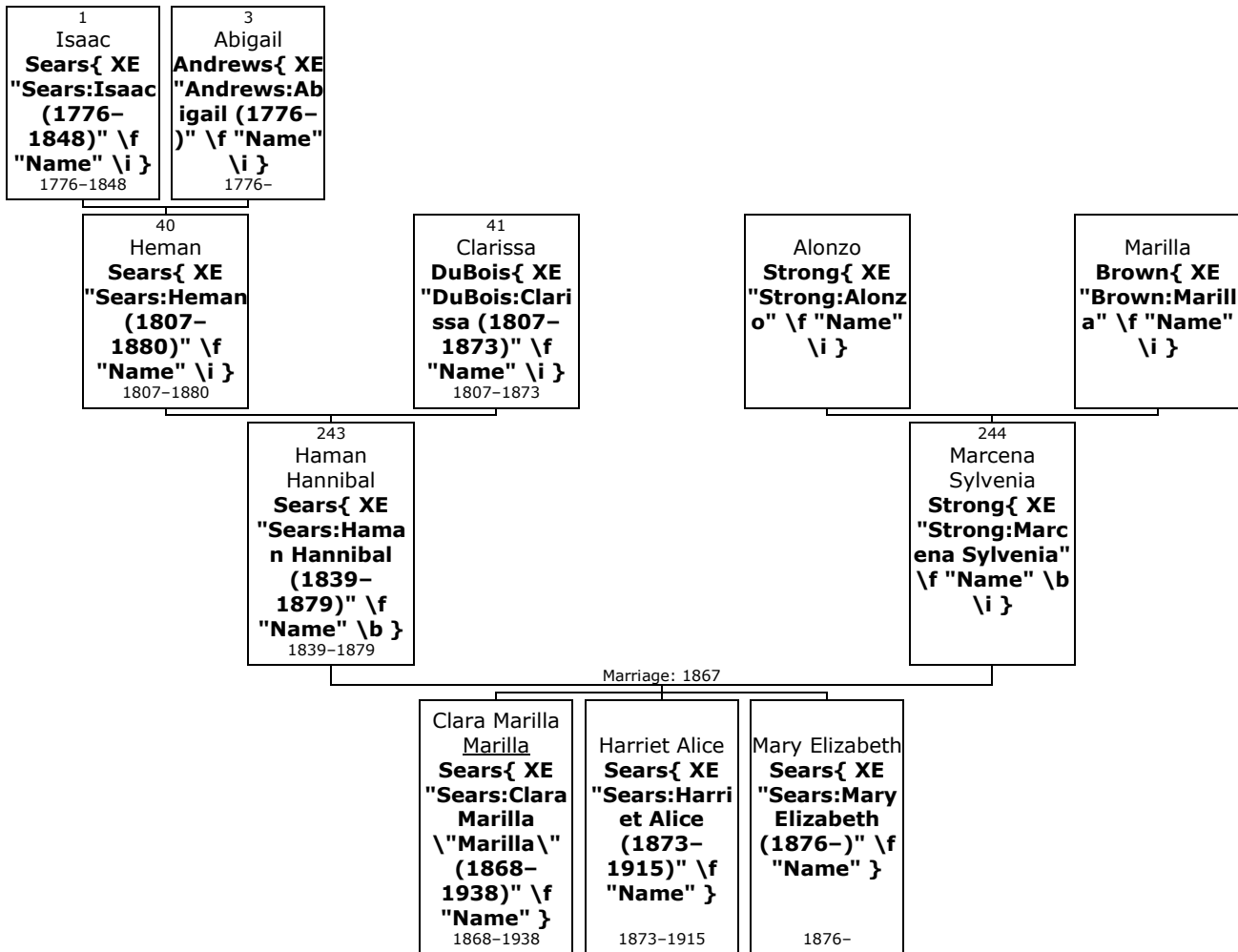

243. Haman Hannibal⁶ Sears{ XE "Sears:Haman Hannibal (1839-1879)" \f "Name" \b } (*Heman⁵, Isaac⁴, Susanna³ Townsend*) was born on Thursday, 18th July 1839, in Newfane, Niagara, New York, USA{ XE "USA, New York, Niagara, Newfane:(43.2867° N, 78.7103° W):Sears, Haman Hannibal (1839-1879)" \f "Place" \i }.^[482] He was the son of Heman Sears{ XE "Sears:Heman (1807-1880)" \f "Name" \i } (40) and Clarissa DuBois{ XE "DuBois:Clarissa (1807-1873)" \f "Name" \i } (41).

Haman Hannibal died on 27th December 1879, at the age of 40.^[482] He was buried in Olcott, Niagara County{ XE "USA, New York, Niagara County, Olcott:(43.3378° N, 78.7148° W):Sears, Haman Hannibal (1839-1879)" \f "Place" \i }.^[482]

!Ceary (by Marietta Goodman): Attended district school and Lockport Union School, Lockport, NY. Although he left school when his father broke his arm and needed his help on the farm, he returned to the Armor School after he was twenty-one. While in Lockport as a student, he boarded with Mrs Birdsall Holly who lived on the west side of Market Street between the railroad bridge and the Bewley building. At one time he, with some other boys, possibly Jacob Goodspeed, Romaine Noble and James Curtis, his friends at the time, furnished a room. Among his father's contributions were a black walnut table (two leaves) and a stout chair (known as a wooden bottomed chair) and a two griddled stove with elevated oven, later used in the sitting room at grandfather's house.

Soon after leaving school father bought of his cousin, Isaac Sears, forty acres of the 120 acre farm originally owned by his grandfather, Isaac Sears.

19 Jun 1867, Haman H Sears was married to Marcena Sylvenia Strong, daughter of Alonzo and Marilla Brown Strong, at Olcott, NY. Not long afterward father bought of Sylvester Sweet thirty-two acres of the

⁴⁸² Ancestry.com, U.S., Find A Grave Index, 1600s-Current (Provo, UT, USA, Ancestry.com Operations, Inc., 2012), Ancestry.com.

farm originally owned by Isaac Sears. 6 Dec 1867 fire, supposed to be of incendiary origin destroyed the barn on the home farm, with contents. Insurance \$300. In 1871 the barn was rebuilt.

He was elected trustee of the school district.

In 1876, in company with Hattie Strong, his sister-in-law, Charles Shaw, his brother-in-law, and Mrs Morris Halstead of Olcott, NY spent a week at the Centennial in Philadelphia. In 1878 he went to Michigan to visit his sister, Polly Lewis. He died after an illness of three days. Services were in Olcott, NY in the Methodist Church, 31 Dec 1879. Rev Eli Whitney preached from John 11:35. Buried at Olcott.

- 244.** Haman Hannibal married **Marcena Sylvania Strong**{ XE "Strong:Marcena Sylvania" \f "Name" \b \i } on Wednesday, 19th June 1867, in Olcott, Niagara{ XE "USA, New York, Niagara, Olcott:(43.3378° N, 78.7148° W):Sears, Haman Hannibal (1839–1879)" \f "Place" }. They had three daughters: Marilla (1868–1938), Harriet (1873–1915) and Mary (1876–). She was the daughter of Alonzo Strong{ XE "Strong:Alonzo" \f "Name" \i } and Marilla Brown{ XE "Brown:Marilla" \f "Name" \i }.

Daughters of Haman Hannibal Sears and Marcena Sylvania Strong:

- f I. **Clara Marilla Marilla⁷ Sears**{ XE "Sears:Clara Marilla \"Marilla\" (1868–1938)" \f "Name" \b } was born on 4th July 1868. She died in 1938 at the age of 69.
- At the age of 21, Marilla married **William R Shearston**{ XE "Shearston:William R (1864–1934)" \f "Name" \b \i } on Monday, 2nd June 1890, at by Rev Ward Pickard in Lockport{ XE "USA, New York, Niagara, Lockport:(43.1706° N, 78.6903° W):Sears, Clara Marilla \"Marilla\" (1868–1938)" \f "Place" } when he was 26 years old. They had five children: Sears (1891–), Alice (1895–), Robert (1897–1898), Everett (1898–1936) and Harriett (1900–).
- William R was born on Monday, 23rd May 1864. He was the son of Edward Shearston{ XE "Shearston:Edward" \f "Name" \i } and Maria Durston{ XE "Durston:Maria" \f "Name" \i }.
- William R reached 69 years of age and died in 1934.
- f II. **Harriet Alice Sears**{ XE "Sears:Harriet Alice (1873–1915)" \f "Name" \b } was born on 15th November 1873.^[483] She died on 29th December 1915, at the age of 42.
- At the age of 24, Harriet Alice Sears married **Charles I Brooks**{ XE "Brooks:Charles I (1872–)" \f "Name" \b \i } on Tuesday, 16th August 1898, when he was 26 years old.^[483] by Rev Eli Whitney of Castile, NY. They had two children: Alice (1899–1899) and James (1904–).
- Charles I was born on Monday, 26th February 1872. He was the son of James Brooks{ XE "Brooks:James" \f "Name" \i } and Ophelia Palmer{ XE "Palmer:Ophelia" \f "Name" \i }.
- f III. **Mary Elizabeth Sears**{ XE "Sears:Mary Elizabeth (1876–)" \f "Name" \b } was born on 15th June 1876.
- At the age of 42, Mary Elizabeth Sears married **Charles I Brooks**{ XE "Brooks:Charles I (1872–)" \f "Name" \b \i } on Saturday, 29th June 1918, when he was 46 years old.^[483] They had no known children.
- Charles I was born on Monday, 26th February 1872.

⁴⁸³ Ancestry.com, New York State, Marriage Index, 1881-1967 (Lehi, UT, USA, Ancestry.com Operations, Inc., 2017), Ancestry.com, New York State Department of Health; Albany, NY, USA; New York State Marriage Index. Record for Harriet A Sears. <http://search.ancestry.com/cgi-bin/sse.dll?db=61632&h=817727&indiv=try>.

Bibliography{ TC "Bibliography" \f C}

"Ancestry Family Tree".

Ancestry Family Trees. Online publication - Provo, UT, USA: Ancestry.com. Original data: Family Tree files submitted by Ancestry members..

Ancestry.com and The Church of Jesus Christ of Latter-day Saints. *1880 United States Federal Census*. Provo, UT, USA: Ancestry.com Operations Inc, 2010.

Ancestry.com. *1790 United States Federal Census*. Provo, UT, USA: Ancestry.com Operations, Inc., 2010.

Ancestry.com. *1800 United States Federal Census*. Provo, UT, USA: Ancestry.com Operations Inc, 2010.

Ancestry.com. *1800 United States Federal Census*. Provo, UT, USA: Ancestry.com Operations Inc, 2010.

Ancestry.com. *1810 United States Federal Census*. Provo, UT, USA: Ancestry.com Operations, Inc., 2010.

Ancestry.com. *1820 United States Federal Census*. Provo, UT, USA: Ancestry.com Operations, Inc., 2010.

Ancestry.com. *1830 United States Federal Census*. Provo, UT, USA: Ancestry.com Operations, Inc., 2010.

Ancestry.com. *1840 United States Federal Census*. Provo, UT, USA: Ancestry.com Operations, Inc., 2010.

Ancestry.com. *1850 United States Federal Census*. Provo, UT, USA: Ancestry.com Operations, Inc., 2009.

Ancestry.com. *1860 United States Federal Census*. Provo, UT, USA: Ancestry.com Operations, Inc., 2009.

Ancestry.com. *1870 United States Federal Census*. Provo, UT, USA: Ancestry.com Operations, Inc., 2009.

Ancestry.com. *1900 United States Federal Census*. Provo, UT, USA: Ancestry.com Operations Inc, 2004.

Ancestry.com. *1910 United States Federal Census*. Provo, UT, USA: Ancestry.com Operations Inc, 2006.

Ancestry.com. *1920 United States Federal Census*. Provo, UT, USA: Ancestry.com Operations Inc, 2010.

Ancestry.com. *1930 United States Federal Census*. Provo, UT, USA: Ancestry.com Operations Inc, 2002.

Ancestry.com. *1940 United States Federal Census*. Provo, UT, USA: Ancestry.com Operations, Inc., 2012.

Ancestry.com. *Andersonville Prisoners of War*. Provo, UT, USA: Ancestry.com Operations Inc, 1999.

Ancestry.com. *California, Voter Registers, 1866-1898*. Provo, UT, USA: Ancestry.com Operations, Inc., 2011.

Ancestry.com. *Canada, Find A Grave Index, 1600s-Current*. Provo, UT, USA: Ancestry.com Operations, Inc., 2012.

Ancestry.com. *Connecticut Revolutionary War Military Lists, 1775-83*. Provo, UT, USA: Ancestry.com Operations Inc, 1999.

Ancestry.com. *Connecticut, Church Record Abstracts, 1630-1920*. Provo, UT, USA, 2013.

Ancestry.com. *Connecticut, Deaths and Burials Index, 1650-1934*. Provo, UT, USA: Ancestry.com Operations, Inc., 2011.

Ancestry.com. *Connecticut, Hale Cemetery Inscriptions and Newspaper Notices, 1629-1934*. Provo, UT, USA: Ancestry.com Operations, Inc., 2012.

Ancestry.com. *Connecticut, Wills and Probate Records, 1609-1999*. Provo, UT, USA: Ancestry.com Operations, Inc., 2015.

- Ancestry.com. *Global, Find A Grave Index for Non-Burials, Burials at Sea, and other Select Burial Locations, 1300s-Current*. Provo, UT, USA: Ancestry.com Operations, Inc., 2012.
- Ancestry.com. *Illinois, County Marriages, 1800-1940*. Lehi, UT, USA: Ancestry.com Operations, Inc., 2016.
- Ancestry.com. *Illinois, Marriage Index, 1860-1920*. Provo, UT, USA: Ancestry.com Operations, Inc., 2015.
- Ancestry.com. *Massachusetts, Compiled Birth, Marriage, and Death Records, 1700-1850*. Lehi, UT, USA: Ancestry.com Operations, Inc., 2018.
- Ancestry.com. *Massachusetts, Death Records, 1841-1915*. Provo, UT, USA: Ancestry.com Operations, Inc., 2013.
- Ancestry.com. *Massachusetts, Marriage Records, 1840-1915*. Provo, UT, USA: Ancestry.com Operations, Inc., 2013.
- Ancestry.com. *Massachusetts, State Census, 1865*. Provo, UT, USA: Ancestry.com Operations, Inc., 2014.
- Ancestry.com. *Massachusetts, Town and Vital Records, 1620-1988*. Provo, UT, USA: Ancestry.com Operations, Inc., 2011.
- Ancestry.com. *Michigan, Death Records, 1867-1950*. Provo, UT, USA: Ancestry.com Operations, Inc., 2015.
- Ancestry.com. *Michigan, Death Records, 1897-1920*. Provo, UT, USA: Ancestry.com Operations, Inc., 2010.
- Ancestry.com. *Minnesota, Territorial and State Censuses, 1849-1905*. Provo, UT, USA: Ancestry.com Operations Inc, 2007.
- Ancestry.com. *Missouri, Marriage Records, 1805-2002*. Provo, UT, USA: Ancestry.com Operations, Inc., 2007.
- Ancestry.com. *New Jersey, Births and Christenings Index, 1660-1931*. Provo, UT, USA: Ancestry.com Operations, Inc., 2011.
- Ancestry.com. *New Jersey, Deaths and Burials Index, 1798-1971*. Provo, UT, USA: Ancestry.com Operations, Inc., 2011.
- Ancestry.com. *New Jersey, Marriage Records, 1670-1965*. Lehi, UT, USA: Ancestry.com Operations, Inc., 2016.
- Ancestry.com. *New Jersey, Wills and Probate Records, 1739-1991*. Provo, UT, USA: Ancestry.com Operations, Inc., 2015.
- Ancestry.com. *New York 10,000 Vital Records of Central New York, 1813-1850*. Lehi, UT, USA: Ancestry.com Operations Inc, 2018.
- Ancestry.com. *New York State, Marriage Index, 1881-1967*. Lehi, UT, USA: Ancestry.com Operations, Inc., 2017.
- Ancestry.com. *New York, Compiled Census and Census Substitutes Index, 1790-1890*. Provo, UT, USA: Ancestry.com Operations Inc, 1999.
- Ancestry.com. *New York, County Marriages, 1847-1849; 1907-1936*. Lehi, UT, USA: Ancestry.com Operations, Inc., 2016.
- Ancestry.com. *New York, Death Index, 1880-1956*. Lehi, UT, USA: Ancestry.com Operations, Inc., 2017.
- Ancestry.com. *New York, Genealogical Records, 1675-1920*. Provo, UT, USA: Ancestry.com Operations Inc, 2004.
- Ancestry.com. *New York, Registers of Officers and Enlisted Men Mustered into Federal Service, 1861-1865*. Provo, UT, USA: Ancestry.com Operations, Inc., 2014.
- Ancestry.com. *New York, State Census, 1855*. Provo, UT, USA: Ancestry.com Operations, Inc., 2013.

- Ancestry.com. *New York, State Census, 1865*. Provo, UT, USA: Ancestry.com Operations, Inc., 2014.
- Ancestry.com. *New York, State Census, 1875*. Provo, UT, USA: Ancestry.com Operations, Inc., 2013.
- Ancestry.com. *New York, State Census, 1905*. Provo, UT, USA: Ancestry.com Operations, Inc., 2014.
- Ancestry.com. *New York, State Census, 1915*. Provo, UT, USA: Ancestry.com Operations, Inc., 2012.
- Ancestry.com. *New York, State Census, 1925*. Provo, UT, USA: Ancestry.com Operations, Inc., 2012.
- Ancestry.com. *New York, U.S. Census Mortality Schedules, 1850-1880*. Provo, UT, USA: Ancestry.com Operations, Inc., 2010.
- Ancestry.com. *New York, Wills and Probate Records, 1659-1999*. Provo, UT, USA: Ancestry.com Operations, Inc., 2015.
- Ancestry.com. *North America, Family Histories, 1500-2000*. Provo, UT, USA: Ancestry.com Operations, Inc., 2016.
- Ancestry.com. *Ohio, County Marriages, 1774-1993*. Lehi, UT, USA: Ancestry.com Operations, Inc., 2016.
- Ancestry.com. *Pennsylvania, Death Certificates, 1906-1963*. Provo, UT, USA: Ancestry.com Operations, Inc., 2014.
- Ancestry.com. *Selected U.S. Federal Census Non-Population Schedules, 1850-1880*. Provo, UT, USA: Ancestry.com Operations, Inc., 2010.
- Ancestry.com. *U.S. City Directories, 1821-1989*. Provo, UT, USA: Ancestry.com Operations, Inc., 2011.
- Ancestry.com. *U.S. Federal Census Mortality Schedules, 1850-1885*. Provo, UT, USA: Ancestry.com Operations, Inc., 2010.
- Ancestry.com. *U.S. National Cemetery Interment Control Forms, 1928-1962*. Provo, UT, USA: Ancestry.com Operations, Inc., 2012.
- Ancestry.com. *U.S. Passport Applications, 1795-1925*. Provo, UT, USA: Ancestry.com Operations, Inc., 2007.
- Ancestry.com. *U.S. Pensioners, 1818-1872*. Provo, UT, USA: Ancestry.com Operations Inc, 2007.
- Ancestry.com. *U.S., Appointments of U. S. Postmasters, 1832-1971*. Provo, UT, USA: Ancestry.com Operations, Inc., 2010.
- Ancestry.com. *U.S., Burial Registers, Military Posts and National Cemeteries, 1862-1960*. Provo, UT, USA: Ancestry.com Operations, Inc., 2012.
- Ancestry.com. *U.S., Civil War Draft Registrations Records, 1863-1865*. Provo, UT, USA: Ancestry.com Operations, Inc., 2010.
- Ancestry.com. *U.S., Find A Grave Index, 1600s-Current*. Provo, UT, USA: Ancestry.com Operations, Inc., 2012.
- Ancestry.com. *U.S., Find A Grave Index, 1600s-Current*. Provo, UT, USA: Ancestry.com Operations, Inc., 2012.
- Ancestry.com. *U.S., Find A Grave Index, 1600s-Current*. Provo, UT, USA: Ancestry.com Operations, Inc., 2012.
- Ancestry.com. *U.S., Newspaper Extractions from the Northeast, 1704-1930*. Provo, UT, USA: Ancestry.com Operations, Inc., 2014.
- Ancestry.com. *U.S., Registers of Deaths of Volunteers, 1861-1865*. Provo, UT, USA: Ancestry.com Operations, Inc., 2012.
- Ancestry.com. *U.S., Revolutionary War Pension and Bounty-Land Warrant Application Files, 1800-1900*. Provo, UT, USA: Ancestry.com Operations, Inc., 2010.
- Ancestry.com. *U.S., Revolutionary War Rolls, 1775-1783*. Provo, UT, USA: Ancestry.com Operations, Inc., 2007.

- Ancestry.com. *U.S., Social Security Applications and Claims Index, 1936-2007*. Provo, UT, USA: Ancestry.com Operations, Inc., 2015.
- Ancestry.com. *U.S., Sons of the American Revolution Membership Applications, 1889-1970*. Provo, UT, USA: Ancestry.com Operations, Inc., 2011.
- Ancestry.com. *U.S., World War I Draft Registration Cards, 1917-1918*. Provo, UT, USA: Ancestry.com Operations Inc, 2005.
- Ancestry.com. *Vermont, Death Records, 1909-2008*. Provo, UT, USA: Ancestry.com Operations, Inc., 2010.
- Ancestry.com. *Vermont, Vital Records, 1720-1908*. Provo, UT, USA: Ancestry.com Operations, Inc., 2013.
- Ancestry.com. *War of 1812 Pension Application Files Index, 1812-1815*. Provo, UT, USA: Ancestry.com Operations Inc, 2010.
- Ancestry.com. *Washington State and Territorial Censuses, 1857-1892*. Provo, UT, USA: Ancestry.com Operations Inc, 2006.
- Ancestry.com. *Washington, Select Death Certificates, 1907-1960*. Provo, UT, USA: Ancestry.com Operations, Inc., 2014.
- Ancestry.com. *Web: Georgia, Find A Grave Index, 1728-2012*. Provo, UT, USA: Ancestry.com Operations, Inc., 2012.
- Ancestry.com. *Web: New York, Find A Grave Index, 1660-2012*. Provo, UT, USA: Ancestry.com Operations, Inc., 2012.
- Ancestry.com. *Web: Warren County, New Jersey, Obituary Index, 1848-1914*. Provo, UT, USA: Ancestry.com Operations, Inc., 2012.
- Ancestry.com. *West Virginia, Deaths Index, 1853-1973*. Provo, UT, USA: Ancestry.com Operations, Inc., 2011.
- Dalby, John. *Minnesota Cemetery Inscription Index, Select Counties*. Provo, UT, USA: Ancestry.com Operations Inc, 2003.
- Dodd, Jordan, Liahona Research, comp. *Illinois Marriages, 1790-1860*. Provo, UT, USA: Ancestry.com Operations Inc, 2004.
- Dodd, Jordan, Liahona Research, comp. *Massachusetts, Marriages, 1633-1850*. Provo, UT, USA: Ancestry.com Operations Inc, 2005.
- Dodd, Jordan. *Illinois Marriages to 1850*. Provo, UT, USA: Ancestry.com Operations Inc, 1997.
- Edmund West, comp.. *Family Data Collection - Births*. Provo, UT, USA: Ancestry.com Operations Inc, 2001.
- Edmund West, comp.. *Family Data Collection - Deaths*. Provo, UT, USA: Ancestry.com Operations Inc, 2001.
- Edmund West, comp.. *Family Data Collection - Individual Records*. Provo, UT, USA: Ancestry.com Operations Inc, 2000.
- FamilySearch.org. *FamilySearch Family Tree*.
- Godfrey Memorial Library, comp.. *American Genealogical-Biographical Index (AGBI)*. Provo, UT, USA: Ancestry.com Operations Inc, 1999.
- Hatcher, Patricia Law. *Abstract of Graves of Revolutionary Patriots*. Provo, UT, USA: Ancestry.com Operations Inc, 1999.
- Native Soil. *Native Soil Manuscripts Index*. Provo, UT, USA: Ancestry.com Operations Inc, 1999.
- Samuel P. May. *The Descendants of Richard Sares (Sears) of Yarmouth, Mass. 1638-1888*. Joel Munsell's Sons, Publishers, 1890, Albany, NY.

Yates Publishing. *U.S. and International Marriage Records, 1560-1900*. Provo, UT, USA: Ancestry.com Operations Inc, 2004.

Index of Places{ TC "Index of Places" \f C}

Canada, British Columbia, Nelson
(49.4931° N, 117.2948° W)
Allison, Mary Ann (1833-)....235

Canada, New Brunswick
(46.3658° N, 66.137° W)
Markell, Mary Jane (1846-1924)
.....208

Canada, Ontario, Frontenac
(44.6668° N, 76.7494° W)
Nutt, Margaret (1804-1883) 153
Sears, Hezekiah Jr (1800-1873)
.....153
Sears, William (ca.1802-1874)
.....153

Canada, Ontario, Frontenac, Bedford Township
Van Valkinburgh, Lavina (1805-1880).....153

Canada, Ontario, Frontenac, Loughborough
Sears, Hezekiah Jr (1800-1873)
.....153

Canada, Ontario, Niagara, Grimsby
(43.2° N, 79.55° W)
Sears, Albert Edgar (1832-1903)
.....234

Canada, Quebec
(47.4278° N, 71.8805° W)
Castle, Lavinia (1812-1838).166
Nutt, Fanny (1805-1861)153
Sears, James (1747-) 61, 74
Sears, Millicent (1786-1868)165
Sears, Sophronia (1817-)....153
Van Valkinburgh, Lavina (1805-1880).....153

Canada, Quebec, Brome-Missisquoi, Farnham, Methodist Cemetery
Sears, Electa (1813-1879)...158

Canada, Quebec, Brome-Missisquoi, Sutton
(45.1° N, 72.6167° W)
Sears, Giles (1810-1851) ...157, 158

Canada, Quebec, Brome-Missisquoi, Sutton, Draper Hill, Sweet Cemetery
Sears, Giles (1810-1851) 158

Canada, Quebec, Caldwell Manor
Sears, Hezekiah (1770-1819)
..... 76, 152
Sears, Hezekiah Jr (1800-1873)
.....153
Sears, Lyman (1799-1857).. 153

Canada, Quebec, Caldwell Manor, prob
Sears, Hezekiah Jr (1800-1873)
..... 153

Canada, Quebec, La Haute-Yamaska, Shefford
(45.4167° N, 72.5833° W)
Castle, Bradley (1786-1848) 165
Castle, Julia Ann (-1845)..... 166
Castle, Lavinia (1812-1838) 166
Castle, Nathan Olmsted (1810-1876)..... 166
Sears, Millicent (1786-1868).76, 165
Sears, Nathan (1768-1838)..76, 151

Canada, Quebec, La Haute-Yamaska, Shefford, Frost Village
Castle, Lavinia (1812-1838) 166

Canada, Quebec, La Haute-Yamaska, Shefford, Waterloo Burial Ground
Castle, Bradley (1786-1848) 165

Canada, Quebec, Le Haut-Richelieu, Noyan
(45.0657° N, 73.299° W)
Sears, William (ca.1802-1874)
..... 153

Canada, Quebec, Missisquoi Co
Nutt, Margaret (1804-1883) 153
Sears, Lyman (1799-1857).. 153

Canada, Quebec, Missisquoi, Clarenceville
Sears, William (ca.1802-1874)
..... 153

Canada, Quebec, Stukeley
Sears, Millicent (1786-1868) 165

England, Devon
(50.8131° N, 3.7526° W)
Gidley, Mary (1825-1900) ... 127

Illinois
Somers, Easter Hester (1823-1859)..... 145

Indiana
Somers, Easter Hester (1823-1859)..... 145

Indiana, Indianapolis
Sears, George (1812-1882). 145

Scotland, Isle of Bale
--Sears, Isabella (1870-) 247

USA
Brown, Elsworth William (ca.1871-) 278
Mandaville, Ina L (ca.1880-1947)..... 280
McKnight, Robert..... 101
Siemdorf, Anna Mary (ca.1882-1959)..... 281
Vail, Sarah (1816-1869) 214

USA, California, Alameda
(37.6539° N, 121.914° W)
Sears, Herman Barnum (1815-1885)..... 187

USA, California, Los Angeles County, Los Angeles
(34.0522° N, 118.2437° W)
Sears, Nathan (1859-1925). 249

USA, California, Los Angeles, Los Angeles
(34.0522° N, 118.2437° W)
Sherwood, Herbert Leon (1863-1931)..... 267

USA, California, Los Angeles, Los Angeles, Assembly District 74
Sears, Nathan (1859-1925). 249

USA, California, Nevada, Grass Valley
(39.2191° N, 121.0611° W)
Norton, Martin Story (1788-1875)..... 161
Sears, Mary Ann (1804-1899)
..... 161

USA, California, San Francisco
(37.7933° N, 122.5548° W)
Haswell, Zimri (1817-1858). 163
Sears, William Henry (1830-)
..... 193

USA, Connecticut
(41.5735° N, 72.7383° W)

Benedict, Philander (1816–1884) 214
 Canfield, John (1830–)..... 243
 Mitchell, Susan Ann (1801–1890) 126
 Sears, Betsy (1848–1917)... 247
 Sears, Clara Maria (1836–1914) 243
 Sears, Emma (1850–)..... 247
 --Sears, Eunice P (1804–) 93
 Sears, Isaac W (1816–1895) 139
 Sears, Knowles (1738–1817) . 18
 Sears, Nathan (1859–1925). 249
 Sears, Samuel (1852–1875) 247
 Sears, Sophy (1804–1826).... 16
 Taylor, Mary F (1844–1880) 247

USA, Connecticut, Fairfield County, Ridgefield

(41.2815° N, 73.4982° W)

Sears, Charles E (1845–1919) 246

USA, Connecticut, Fairfield, Bethel

(41.3729° N, 73.4114° W)

Benedict, Philander (1816–1884) 214
 Hoyt, Elizabeth H (1829–1886) 193
 Sears, Charles E (1845–1919) 246
 Vail, Sarah (1816–1869) 214

USA, Connecticut, Fairfield, Bridgeport

(41.167° N, 73.2048° W)

McGough, Catherine (1859–1908) 249
 Sears, Samuel (1852–1875) 247

USA, Connecticut, Fairfield, Danbury

(41.3948° N, 73.454° W)

Benedict, Ezra Pearce (1792–1852) 30, 212
 Benedict, Philander (1816–1884) 214
 Blackman, Adoniram S (1837–1879) 244
 Bolger, Mary A (1858–1908) 248
 Gregory, Adeline (1801–1836) 40, 240
 Gregory, Caleb Curtis (1771–1845) 40
 Haviland, Charity (1750–1836) 18
 Jarvis, Marietta (1814–1905) 243
 Platt, Lyman (1819–1866)... 189
 Sears, Abijah (1774–1839)... 21, 35, 37
 Sears, Benjamin F (1856–1926) 248
 Sears, Betsy (1848–1917)... 247
 Sears, Charles (1780–1836) . 21, 41
 Sears, Charles E (1845–1919) 246

Sears, Clara Maria (1836–1914) 243
 Sears, David H (1794–1830) 19, 46
 Sears, Desire (1778–1879)... 21, 39
 Sears, Edwin Collins (1808–1866) 42, 242
 Sears, Emma (1850–)..... 247
 Sears, Esther Camilla (1829–) 190
 Sears, Francis Augustus "Frank" (1833–) 193
 Sears, George (1823–1866) . 42, 245
 Sears, George (1854–) 248
 Sears, Henrietta Louisa (1835–) 191
 Sears, Isaac (1776–1848) 13, 21
 Sears, Jacob Brush (1823–1893) 189
 Sears, Knowles (1768–1848). 21
 Sears, Lewis (1795–1868).... 80, 192
 Sears, Martha Matilda (1821–1866) 188
 Sears, Mary Ann (1841–1880) 244
 Sears, Mary Eliza (1836–) ... 194
 Sears, Nathan (1859–1925) 249
 Sears, Samuel (1852–1875) 247
 Sears, Theodore Crosby (1828–1898) 192
 Sears, William Henry (1830–) 193

USA, Connecticut, Fairfield, Danbury, 2 mi NE

Sears, Desire (1778–1879)... 39

USA, Connecticut, Fairfield, Danbury, Bogg's District

Sears, Sophy (1804–1826).... 16

USA, Connecticut, Fairfield, Danbury, lives

Gregory, Delos (1797–) 40

USA, Connecticut, Fairfield, Danbury, perh

Andrews, Abigail (1776–)..... 15
 Boughton, Catharine (1776–1816) 37
 Richmond, Rose (1834–)..... 193
 Sears, Angeline (1799–1864) 15, 49
 Sears, Heman (1807–1880).. 16, 57
 Sears, Kate (1798–) 15
 Sears, Sophy (1804–1826).... 15
 Woods, Polly (1780–1858) 14

USA, Connecticut, Fairfield, Danbury, Ward 2

Sears, Benjamin F (1856–1926) 248

USA, Connecticut, Fairfield, Fairfield, Mill Plain

Sears, Eliza Ann (1823–1879) 184
 Sears, George Belden (1809–1877) 180

USA, Connecticut, Fairfield, Greenfield, prob

Sears, Seth Jr (1769–1819) .123

USA, Connecticut, Fairfield, New Fairfield

(41.4664° N, 73.4861° W)

Sherwood, Noah Schuyler (1786–1873) 52

USA, Connecticut, Fairfield, Norwalk

(41.1176° N, 73.4079° W)

Quintard, Ann Eliza "Eliza" (1818–) 178
 Raymond, Zacheus (1766–1844) 119
 Sears, Seth A (1810–1880) ..124

USA, Connecticut, Fairfield, Redding

(41.3025° N, 73.3839° W)

Sanford, Betsy Ann (1816–1889) 184
 Sears, Comfort (1751–1827) . 79
 Sears, Gould Boughton (1811–1900) 184
 Sears, Isaac (1776–1848)..... 13
 Sears, Jane Eliza (1838–)..... 243
 Sears, Knowles (1738–1817). 18

USA, Connecticut, Fairfield, Redding, perh

Butler, Charles E (1834–)..... 244

USA, Connecticut, Fairfield, Ridgefield

(41.2815° N, 73.4982° W)

Gregory, Charles (?)..... 40
 Griffiths, Avilda S (1800–1890) 175
 Haviland, Charity (1750–1836) 18
 Jarvis, Marietta (1814–1905) 243
 Olmstead, Elizabeth (1746–) . 76
 Rockwell, Marinda B (1813–1831) 181
 Sears, Atha (1790–1827) 80, 213
 Sears, Betsy (1848–1917) ... 247
 Sears, Betty (1763–1846) 21, 25, 26

Sears, Camilla Maria (1816–1886).....184
 Sears, Charity (1789–1859). 19, 43
 Sears, Charles (1780–1836). 21, 41, 42
 Sears, Charles E (1845–1919)246
 Sears, Clara M (1804–1821).. 42
 Sears, Clara Maria (1836–1914)243
 Sears, Comfort (1751–1827) 61, 78, 79
 Sears, Daniel (1762–1840) .. 20, 23
 Sears, David H (1794–1830) 19, 46
 Sears, Desire (1778–1879) .. 21, 39
 Sears, Desire (1782–1854) .. 80, 176
 Sears, Edwin Collins (1808–1866)..... 42, 242
 Sears, Elizabeth (1790–1880)19, 44
 Sears, Esther (1780–1811) .. 80, 174
 Sears, Esther Camilla (1829–)190
 Sears, Eunice (1784–1858).. 80, 177
 Sears, George (1823–1866).245
 Sears, George Belden (1809–1877).....181
 Sears, Henrietta Louisa (1835–)190
 Sears, James (1704–1791) ... 59
 Sears, James (1788–1878) .. 80, 179
 Sears, John (1772–1839).21, 32
 Sears, Joseph Crane (1792–1857)..... 80, 185
 Sears, Knowles (1738–1817) 17, 18, 61
 Sears, Knowles (1768–1848). 21
 Sears, Lewis (1795–1868) ... 80, 191
 Sears, Margaret Eliza (1831–1915).....190
 Sears, Mary (1770–1866)21, 29, 31
 Sears, Miles (1798–1870)170
 Sears, Phebe (1796–1864).... 19
 Sears, Polly M (1800–1873) . 81, 195
 Sears, Susanna (1766–) .. 21, 28
 Sears, Thirza (1779–1861)...169
 Smith, Betsy (1784–1869).... 42
 St. John, James (1800–1882)240
 Townsend, Susanna (1740–1782)..... 20

USA, Connecticut, Fairfield, Ridgefield, Joe's Hill

Sears, Thirza (1779–1861)... 80, 168

USA, Connecticut, Fairfield, Ridgefield, perh

Benedict, Camilla (1821–1832) 176
 Benedict, Edwin Sears (1824–) 177
 Benedict, Elijah (1827–) 214
 Benedict, Joanna (1820–1860) 214
 Benedict, Philander (1816–1884) 213
 Benedict, Tamar (1813–)..... 213
 Benedict, Ursula (1818–1832) 176
 Crane, Eunice (1754–1839) ...80
 Crosby, Stephen B (1784–)....43
 Gregory, Sarah E (1823–1893) 245
 Griffiths, Jeremiah (1776–1814) 174
 Hawley, Aaron (1790–).....27
 Hawley, Arza (1792–1823)27
 Hawley, Comfort Sears (1788–1874).....27
 Hawley, Elizabeth (1786–)27
 Hawley, George (1800–) 27, 211
 Hawley, Harvey (1794–).....27
 Hawley, Henry (1798–)27
 Hawley, James (1803–1872)..27
 Hawley, Maria (1807–).....27
 Hawley, Matilda (1805–1877).27
 Hawley, Nathan (1763–1810).26
 Hawley, Samuel (1796–1852) 27
 Hawley, Susanna (1810–).....27
 Morris, Sally (1798–)46
 Sears, Camilla (1786–1815)..80, 178
 Sears, Camilla (1807–1827). 171
 Sears, Caroline Ophelia (1824–1911).....173
 Sears, Clarissa (1801–1824) 170
 Sears, Esther (1813–1883).. 172
 Sears, Eunice (1803–)..... 171
 Sears, George E (1815–1884) 172
 Sears, Hiram (1811–1904)... 171
 Sears, James William (1809–) 171
 Sears, Mary Ann (1819–1889) 173
 Sears, Polly Matilda (1805–1853) 171
 Sears, Rebecca (1750–1842) 61, 77
 Tobey, Desire (1707–1781) ...60
 Weed, James (1783–1814) ..177
 Weed, James Orville (1814–)178
 Weed, Joseph Oscar (1812–)178
 White, Charity (1792–1883). 180

USA, Connecticut, Fairfield, Stratford

(41.1845° N, 73.1332° W)
 McGough, Catherine (1859–1908)..... 249

USA, Connecticut, Fairfield, Westport

(41.1415° N, 73.3579° W)
 Sears, Benjamin F (1856–1926) 248

USA, Connecticut, Hartford

(41.8071° N, 72.735° W)
 Sears, Joseph Crane (1792–1857)..... 185

USA, Connecticut, Litchfield, New Hartford

(41.8822° N, 72.9775° W)
 Merrell, Lydia C (1809–)..... 110

USA, Connecticut, Litchfield, New Milford

(41.577° N, 73.4084° W)
 Sears, Mary Ann (1841–1880) 244

USA, Connecticut, Litchfield, Norfolk

(41.9939° N, 73.2025° W)
 French, Matilda (1823–1890)110

USA, Connecticut, Litchfield, Sharon

(41.8792° N, 73.4772° W)
 Sears, Mary Ann (1841–1880) 244

USA, Connecticut, Millplain

Sears, Camilla Maria (1816–1886).....184
 Sears, Clarke Crosby (1827–1915)..... 184
 Sears, Gould Boughton (1811–1900)..... 183
 Sears, Joseph Crane (1792–1857).....80, 185

USA, Connecticut, New Haven, New Haven

(41.3082° N, 72.9281° W)
 Jones, Angeline Sears (1827–1898)..... 50

USA, Connecticut, New London, Lebanon

(41.6361° N, 72.2131° W)
 Benedict, Czar (1769–1858) 176
 Kingsley, Cyrus Hills (1789–1878)..... 220

USA, Connecticut, New London, Lebanon, perh

Benedict, Czar (1769–1858) 176

USA, Connecticut, Tolland, Hebron

(41.6579° N, 72.3659° W)

- Carver, Rachel Maria (1818–1905) 137
- USA, Connecticut, Tolland, Mansfield City, perh**
Stearns, Priscilla (1768–1799)90
- USA, Connecticut, Windham, Pomfret**
(41.8975° N, 71.963° W)
Hibbard, Frances Marion (1830–1887) 262
- USA, Florida, Pasco**
(28.301° N, 82.4386° W)
Sherwood, Edie (1877–1974)267
- USA, Georgia, Sumter County, Andersonville**
(32.196° N, 84.1399° W)
Sherwood, Jones Ebenezer (1831–1864) 262
- USA, Georgia, Sumter, Andersonville, Fort Sumter**
Sherwood, Jones Ebenezer (1831–1864) 53, 262
- USA, Illinois**
(39.7333° N, 88.5° W)
Crane, Edith M (1874–1927) 276
Sears, Laura Dickinson (1801–1871) 86
Sears, Louisa (1824–1894).. 202
- USA, Illinois, Cook, Chicago**
(41.85° N, 87.6501° W)
Lyman, Charles Pyncheon (1831–1868) 237
- USA, Illinois, Hancock**
(40.4021° N, 91.1689° W)
Lincoln, Almira (1823–1896) 146
Sears, George (1812–1882). 145
Sears, Heman (1818–1893). 146
- USA, Illinois, Hancock, Burnside**
(40.5039° N, 91.1° W)
Lincoln, Almira (1823–1896) 146
Sears, Heman (1818–1893). 146
- USA, Illinois, Hancock, Durham**
(40.5967° N, 91.0895° W)
Sears, George (1812–1882). 145
- USA, Illinois, Hancock, Pilot Grove**
(40.5028° N, 91.0794° W)
Sears, Heman (1818–1893). 146
- USA, Illinois, Kane County, Aurora**
(41.7484° N, 88.241° W)
Sears, John Sylvester (1867–1958) 276
- USA, Illinois, Kane, Aurora, Ward 3**
Crane, Edith M (1874–1927) 276
Sears, John Sylvester (1867–1958) 276
- USA, Illinois, Kane, Aurora, Ward 4**
Sears, John Sylvester (1867–1958) 276
- USA, Illinois, Kane, Sugar Grove**
(41.7614° N, 88.4436° W)
Brooks, Chauncy (1798–1885)86
Sears, Laura Dickinson (1801–1871) 86
- USA, Illinois, Kendall County, Plano**
(41.6628° N, 88.537° W)
Sears, Archibald (1802–1893) 137
- USA, Illinois, Kendall, Plano**
(41.6628° N, 88.537° W)
Carver, Rachel Maria (1818–1905) 137
Hadden, Susan (1815–1845)137
Sears, Archibald (1802–1893) 137
- USA, Illinois, McHenry, Greenwood**
(42.3925° N, 88.3893° W)
Scofield, Amos (1796–1844) 175
- USA, Illinois, McHenry, Nunda**
(42.2836° N, 88.2784° W)
Sears, Lovilly (1786–1856).... 88
- USA, Illinois, Whiteside, Erie**
(41.6564° N, 90.0793° W)
--Sears, Ruth (1792–1876) . 201
- USA, Illinois, Whiteside, Portland**
(41.6625° N, 89.98° W)
Sears, Louisa (1824–1894).. 202
- USA, Indiana, Brushy Prairie**
Sears, Eleazar (1801–1841) .. 89
- USA, Indiana, Lagrange**
(41.6421° N, 85.4262° W)
Wheaton, Sarah (1806–1846) 89
- USA, Indiana, Lagrange, Brushy Chapel Cemetery**
Sears, Eleazar (1801–1841) .. 89
- USA, Indiana, Lagrange, Lagrange**
(41.6417° N, 85.4167° W)
Wheaton, Sarah (1806–1846) 89
- USA, Iowa, Des Moines, Burlington**
(40.8075° N, 91.1129° W)
Sears, Henry Williams (1833–1879)235
- USA, Iowa, Wapello, Ottumwa**
(41.02° N, 92.4113° W)
Blake, Charles F (1823–1897)221
Kingsley, Polly (1819–1876).221
- USA, Iowa, Wapello, Ottumwa, Ottumwa Cemetery**
Blake, Charles F (1823–1897)221
Kingsley, Polly (1819–1876).221
- USA, Kansas, Franklin, Ottawa**
(38.6156° N, 95.2678° W)
Sears, Theodore Crosby (1828–1898)192
- USA, Kansas, Republic**
(39.8282° N, 97.6503° W)
Ocobock, Albert (1815–1882)202
Sears, Louisa (1824–1894) ..202
- USA, Louisiana, Orleans, New Orleans**
(29.9547° N, 90.0751° W)
Sears, Charles Follett (1817–1841)162
- USA, Massachusetts**
(42.1562° N, 71.5662° W)
Chamberlain, Sally (–1880)... 90
Robinson, Martha A. (1823–1901)139
Sears, Hezekiah (1770–1819) 76, 152
- USA, Massachusetts, Barnstable, Eastham**
(41.8301° N, 69.9739° W)
Tobey, Desire (1707–1781)... 60
- USA, Massachusetts, Barnstable, Harwich**
(41.6862° N, 70.0758° W)
Crosby, Reuben (1735–1819) 67

**USA, Massachusetts,
Barnstable, Yarmouth**
(41.7057° N, 70.2286° W)

Sears, David (1731-1827)60, 63
Sears, James (1704-1791) .. 59, 60
Sears, Sarah (1732-1810)61, 67
Sears, Sarah (1734-)..... 70
Sears, Seth (1736-1809).61, 69
Sears, Thankful (1734-1772)61, 68

**USA, Massachusetts,
Barnstable, Yarmouth,
perh**

Crosby, Abigail (1752-)..... 67
Foster, James (1738-1819)... 68
Foster, James (1771-1855)... 69
Foster, Mary (1764-1830) ... 69, 113
Sears, Desire (1747-) 61, 73
Sears, James (1747-) 61, 74

**USA, Massachusetts,
Berkshire, Lee**
(42.3043° N, 73.2482° W)

Sears, James (1818-1897) ..110
Sears, John (1812-1887).....109
Sears, Levi Lincoln (1825-1904)110
Thacher, Martha (1815-1887)109

**USA, Massachusetts,
Berkshire, Lee, perh**

Schofield, Sarah W (1827-1856)110

**USA, Massachusetts,
Berkshire, Lenox**
(42.3565° N, 73.2849° W)

Bradley, Elizabeth M (1821-)108
Bristol, James (1802-)104
Butler, Almira (1790-1857).108, 109
Butler, Levi (1796-)..... 97
Carr, Huldah (1763-) 88
Carrier, Ira (1805-) 99
Clark, Chloe (1807-1847)..... 98
Foster, Anna (1779-1863) 96
Gunn, Lavina (1771-1847) ... 85
Howland, Emily Jerusha "Jerush" (1812-1898)..... 98
Howland, Polly (1800-1869) 85, 86
Judd, Mariette (1811-1881).. 98
Merrell, Lydia C (1809-)110
Paddock, Mary (1734-1826).. 65
Phelps, John Henry (1792-1874) 93
Rogers, Lucius D (1806-).....104
Sabin, Mary "Polly" (1803-1879) 97
Schofield, Sarah W (1827-1856) 110, 111
Sears, Ann Maria (1813-1847) 99

Sears, Bethia (1756-1826) ...65, 83
Sears, Calvin (1769-1859) ...65, 92
Sears, Charles Andrew (1803-1855).....91
Sears, Chauncey (1799-1841)85
Sears, David (1731-1827)....61, 64, 65
Sears, David (1761-1842)....88
Sears, David (1785-1855).....88
Sears, David (1808-).....108
Sears, Dioclesian (1808-1905)104
Sears, Elijah (1771-)65
Sears, Elijah (1794-)90
Sears, Elijah (1814-1878) ..109, 110
Sears, Elizabeth (1775-) 66, 100
Sears, Fannie (1802-1872)....93
Sears, Hannah (1821-)95
Sears, Harriet (1819-1888) ...99
Sears, James (1776-1847) ...66, 102, 103
Sears, James (1818-1897) ..110
Sears, Jared (1779-1828)76, 160
Sears, John (1812-1887)109
Sears, John Calvin (1804-1874)93
Sears, Laura Dickinson (1801-1871).....86
Sears, Levi Lincoln (1825-1904)110, 111
Sears, Lucy (1802-1872).....103
Sears, Luther (1774-1857) ...65, 95, 96
Sears, Luther (1806-1877)98
Sears, Maria (1829-1899) ... 111
Sears, Marietta (1809-1896) .99
Sears, Marshall (1802-1883) .97
Sears, Mary Maria (1800-1811)93
Sears, Melissa (1798-).....91
Sears, Nancy (1800-1883)97
Sears, Nelson (1798-1881)....96
Sears, Patty (1806-1876)....103
Sears, Philip (1759-1831) 65, 84
Sears, Phillip (1812-1885) ...104
Sears, Polly (1777-) 66, 105
Sears, Polly (1796-)91
Sears, Polly (1827-1897)111
Sears, Polly Hubby (1806-)....93
Sears, Sally (1810-)104
Sears, Samuel H (1808-1881)108
Sears, Sarah (1816-1886)...110
Sears, Zachariah (1778-1865) 66, 105, 106
Sears, Zachariah P (1804-1900)97
Sears, Zachariah Paddock (1806-1888).....107
Stearns, Priscilla (1768-1799)90
Washburn, Frederick (1815-)..99

**USA, Massachusetts,
Berkshire, Lenox, New
Lenox**

Gunn, Lavina (1771-1847)85

**USA, Massachusetts,
Berkshire, Lenox, New
Lenox Cemetery**
Sears, Luther (1806-1877)....98

**USA, Massachusetts,
Berkshire, Lenox, New
Lenox Rd, Sears
Cemetery**
Howland, Emily Jerusha "Jerush" (1812-1898).....98

**USA, Massachusetts,
Berkshire, Lenox, prob**
Sears, Zachariah P (1804-1900)97

**USA, Massachusetts,
Berkshire, Lenox, pub**
Sears, Calvin (1769-1859)92
Sears, Sally (1810-)104
Sears, Zachariah (1778-1865)106

**USA, Massachusetts,
Berkshire, Lenox,
Sears Cemetery**
Sears, James (1802-1803)..103
Sears, Sophy (1801-1801)..103

**USA, Massachusetts,
Berkshire, Pittsfield**
(42.4501° N, 73.2454° W)
Brown, Sarah (1815-).....94
Goodrich, Jacob (1755-1833) 83
Gunn, Lavina (1771-1847)85
Howland, Polly (1800-1869)..85
Hubby, Mary (1768-1807).....93
Judd, Lucy (1776-1841).....103
Sears, Chauncey (1799-1841)85
Sears, George Washington (1811-).....94
Sears, James (1818-1897)..110
Sears, Mary Maria (1800-1811)93
Sears, Philip (1759-1831)85
Sears, Zachariah Paddock (1806-1888).....107

**USA, Massachusetts,
Berkshire, Pittsfield,
perh**
Goodrich, George (1783-)84
Goodrich, Jacob (1781-)83

**USA, Massachusetts,
Berkshire, Richmond**
(42.3731° N, 73.3676° W)
Brooks, Chauncy (1798-1885)86

**USA, Massachusetts,
Berkshire, Stockbridge**
(42.2876° N, 73.3204° W)
Rewey, Oliver (1804-1883) .231

**USA, Massachusetts,
Berkshire, Washington**
(42.3659° N, 73.1162° W)

- Sears, David (1785–1855)..... 88
- USA, Massachusetts, Essex, Andover**
(42.6584° N, 71.137° W)
Schofield, Charlotte M (1836–)
..... 111
- USA, Massachusetts, Franklin, Ashfield**
(42.5265° N, 72.7884° W)
Hall, Sally (1784–) 106
Millard, Mary Ann (1807–1876)
..... 107
- USA, Massachusetts, Hampden, Wilbraham**
(42.1237° N, 72.4315° W)
Partridge, Edward Turner (1799–1887) 171
- USA, Massachusetts, Hampshire, Goshen**
(42.4404° N, 72.7996° W)
Cargill, George (1802–1872) 103
- USA, Massachusetts, Hampshire, Hadley**
(42.3418° N, 72.5884° W)
Porter, (1803–)..... 164
- USA, Massachusetts, Hampshire, Worthington**
(42.41° N, 72.9356° W)
Sears, Ann Maria (1816–)..... 95
Sears, William Anson (1813–1883) 95
- USA, Massachusetts, Plymouth, Middleborough**
(41.8945° N, 70.9069° W)
Fobes, Zebina Eaton (1804–1886) 162
- USA, Michigan**
(44.5917° N, 85.025° W)
St. John, James (1800–1882)
..... 240
St. John, Lucy Ann (1826–1907)
..... 241
- USA, Michigan, Branch County, Quincy**
(41.9442° N, 84.8839° W)
Sears, Clarke Crosby (1827–1915) 184
Warner, Harriet Elizabeth (1832–1913) 185
- USA, Michigan, Branch, Quincy**
(41.9442° N, 84.8839° W)
Sanford, Betsy Ann (1816–1889)
..... 184
- Sears, Clarke Crosby (1827–1915) 184
Sears, Gould Boughton (1811–1900) 183
Warner, Harriet Elizabeth (1832–1913) 185
- USA, Michigan, Calhoun Co., Le Roy, perh**
Bushnell, Asa (1827–)..... 211
Bushnell, Asa West (1801–). 211
Bushnell, John (1829–) 211
- USA, Michigan, Calhoun, Le Roy**
(44.0382° N, 85.4526° W)
Sears, Maria (1805–1841).... 25, 211
- USA, Michigan, Eaton, Charlotte**
(42.5637° N, 84.8358° W)
Sears, Emily Hyde (1805–1877)
..... 161
- USA, Michigan, Eaton, Vermontville**
(42.6289° N, 85.0242° W)
Robinson, Henry (1809–1891)
..... 161
- USA, Michigan, Hillsdale, Allen**
(41.957° N, 84.7677° W)
Sears, Charles (1800–1870) . 37, 230
- USA, Michigan, Jackson**
(42.2479° N, 84.4245° W)
Gregory, Adeline (1801–1836)
..... 40, 240
- USA, Michigan, Jackson, Columbia**
(42.1039° N, 84.2867° W)
St. John, James (1800–1882)
..... 240
- USA, Michigan, Kalamazoo, Kalamazoo**
(42.2917° N, 85.5872° W)
Sears, Edward (1805–1875) .. 89
Sears, John (1807–1877)..... 89
- USA, Michigan, Kent, Grand Rapids**
(42.9634° N, 85.6681° W)
Sears, Charity (1789–1859) . 19, 43
- USA, Michigan, Livingston, Fowlerville**
(42.6606° N, 84.073° W)
Spencer, Norman (1800–1872)
..... 130
- USA, Michigan, Livingston, Fowlerville, perh**
Spencer, Norman (1800–1872)
..... 129
- USA, Michigan, Macomb, East Detroit**
(42.4657° N, 82.946° W)
Sears, Elijah (1814–1878).... 109
- USA, Michigan, Montcalm, Cato**
(43.4431° N, 85.2647° W)
Sears, Jane Eliza (1838–)..... 243
- USA, Michigan, Muskegon**
(43.2871° N, 86.4465° W)
Sears, Delphine Augusta (1842–1915) 236
- USA, Michigan, Muskegon, Whitehall**
(43.41° N, 86.3487° W)
Sears, Albert Edgar (1832–1903)
..... 234
- USA, Michigan, Newaygo, Troy**
(43.7431° N, 86.0192° W)
Crosby, Tertullus (1775–1874)
..... 67, 112
- USA, Minnesota, Goodhue County, Zumbrota**
(44.2941° N, 92.6691° W)
Griffiths, Avilda S (1800–1890)
..... 175
- USA, Minnesota, Goodhue, Zumbrota**
(44.2941° N, 92.6691° W)
Griffiths, Avilda S (1800–1890)
..... 175
- USA, Minnesota, Washington, Afton**
(44.9028° N, 92.7835° W)
Castle, Nathan Olmsted (1810–1876) 166
- USA, Missouri, Nodaway, Green City**
(40.2682° N, 92.9532° W)
McKnight, Calvin Sears (1804–1872) 101
- USA, Missouri, St Louis**
(38.6794° N, 90.3916° W)
Barager, Charles Fredrick Sr (1838–1891) 208
- USA, Nebraska, Hamilton, Aurora**
(40.8672° N, 98.0042° W)
Carver, Rachel Maria (1818–1905) 137

USA, New Hampshire

(43.6855° N, 71.5776° W)
 Boardman, Maria (1800-1888)
132

USA, New Jersey

(40.1388° N, 74.6769° W)
 --Sears, Sally A (1821-1872)
228

USA, New Jersey, Camden, Camden

(39.926° N, 75.1196° W)
 Brush, Mary A (1796-1872) .188

USA, New Jersey, Cumberland, Landis

(39.3746° N, 74.9638° W)
 Sears, Jacob Brush (1823-1893)
189

USA, New Jersey, Essex

(40.7873° N, 74.2463° W)
 Sears, George Belden (1809-1877).....181

USA, New Jersey, Essex County, Newark

(40.7357° N, 74.1724° W)
 Sears, George Belden (1809-1877).....181

USA, New Jersey, Essex, Newark

(40.7357° N, 74.1724° W)
 Sears, George Belden (1809-1877)..... 180, 181

USA, New Jersey, Essex, Orange, Ward 1

Sears, Charles E (1845-1919)
246

USA, New Jersey, Essex, West Orange, Ward 3

Sears, Charles E (1845-1919)
246

USA, New Jersey, Sussex, Wantage, Clove Valley Dutch Reformed Church

Cartwright, Matilda (1801-) .228

USA, New York

(42.7531° N, 74.2224° W)
 Barager, Judge Samuel (1794-1871).....208
 Boardman, Maria (1800-1888)
132
 Brandt, Rosa M (1872-1948)277
 Christy, Charles Wesley (1864-1948).....284
 Christy, Elizabeth Ann (1858-1941).....283
 Christy, James (1830-)282

Christy, Jennie Lynd (1861-1919)..... 283
 Christy, Sara Ella (1856-1905)
283
 Hart, Louisa Celestia (1836-1898).....229
 Lamerson, Susan (1814-1904)
218
 McKnight, Calvin Sears (1804-1872)..... 101
 McKnight, Robert101
 McQueen, Adeline E254
 Ocobock, Albert (1815-1882)
202
 Perry, Mary M (1832-1883) .196
 Price, Anna Crosby.....250
 Raymond, Seth Sears (1798-1873).....120
 Russell, Huldah (ca.1816-) ..102
 Sears, Ann Eliza (1857-1892)
274
 Sears, Burt (1869-1952).....276
 Sears, Caroline "Carrie" (1872-1951).....277
 Sears, Catherine M (1832-) .210
 Sears, Corydon Birch (1839-1905).....236
 Sears, Enoch Smith (1795-1875)
116
 Sears, Evaline "Eva" (1873-1949).....278
 Sears, George (1812-1882) .145
 Sears, George (1854-).....247
 Sears, George W (1840-)210
 Sears, Heman (1861-1885) .275
 Sears, Hiram (1811-1904)...172
 Sears, Jane A (1847-).....210
 Sears, Jennie H (1864-1920)275
 Sears, John Chester (1836-) 210
 Sears, John Sylvester (1867-1958).....276
 Sears, Lewis (1834-)210
 Sears, Maria (1826-)202
 Sears, Marietta "Etta" (1859-1932).....274
 --Sears, Mary (ca.1807-)172
 --Sears, Phebe (1817-).....135
 Sears, Rufus (1819-1876)...199
 --Sears, Sally A (1821-1872)
228
 Sears, Smith (1841-).....135
 Sears, Theodore Crosby (1828-1898).....193
 Sears, Thomas (1745-1804) .61, 71
 Sears, Thomas Baldwin (1789-1871).....131
 Sears, Wilson "Willie" (1876-1928).....279
 Shaw, Charles (1812-).....289
 Shaw, Elsie Sears (1875-)...289
 Sheldon, Hannah "Betsy" (1807-)
138
 Sherwood, Edie (1877-1974)267
 Sherwood, Herbert Leon (1863-1931).....267
 Sherwood, John (1834-1909)53, 264
 Sherwood, Jones Ebenezer (1831-1864).....262

Sherwood, May (1866-1872)267
 Sherwood, Myron (1836-1904)
266
 Smith, Ammi (1824-1909) ..285
 Spalding, Emily Cozzens (1838-1918).....267
 Tallman, Sarah (1809-1876)158
 Townsend, Amanda M (1811-)
210
 Underhill, Charles Munson ...250
 Williams, Cynthia Marie (1810-1885).....233
 Wilson, Henry O (1875-1963)
289
 Young, Thomas Sears (1813-1904).....148

USA, New York, Albany

(42.6029° N, 73.9717° W)
 McKnight, Robert.....101
 Sears, Betty (1763-1846) 21, 26

USA, New York, Albany County, Guilderland

(42.7044° N, 73.912° W)
 Jones, Almira A (1820-1910) .50

USA, New York, Albany County, Voorheesville

(42.654° N, 73.9287° W)
 Jones, Almira A (1820-1910) .50

USA, New York, Albany, Rensselaerville

(42.5161° N, 74.1383° W)
 Sears, Arza (1790-1859)24, 197

USA, New York, Albany, Rensselaerville, perh

Sears, Abijah (1798-1837)24
 Sears, Ahiram (1795-1856)..24, 203
 Sears, Alfred (1789-1856).....24
 Sears, Ambrose (1793-1843)24, 201
 Sears, Maria (1805-1841)25, 211
 Sears, Rufus (1802-1866)....25, 209
 Sears, Ruhamah (1796-1878)
24, 207
 Warin, Catharine (1767-1860)
24

USA, New York, Allegany

(42.2549° N, 78.022° W)
 Lincoln, Almira (1823-1896) 146

USA, New York, Allegany, Caneadea, perh

Lyman, Charles Pyncheon (1831-1868).....236

USA, New York, Broome

(42.1642° N, 75.8197° W)
 Sears, Corydon Birch (1839-1905).....236

USA, New York, Broome County, Johnson City

(42.1156° N, 75.9592° W)
Sears, Corydon Birch (1839–1905) 236

USA, New York, Broome, Binghamton

(42.0987° N, 75.918° W)
Markell, Mary Jane (1846–1924) 208
Sears, Caroline Miranda (1848–1934) 238
Sears, Charles Williams (1830–1915) 234
Sears, Oliver Williams (1845–>1916) 237

USA, New York, Broome, Binghamton, perh

Bartlett, Georgianna (1853–)238

USA, New York, Broome, Binghamton, Ward 7

Sears, Oliver Williams (1845–>1916) 237

USA, New York, Broome, Chenango

(42.1959° N, 75.9008° W)
Sears, Charles Williams (1830–1915) 234

USA, New York, Cattaraugus, Cold Spring

(42.0969° N, 78.865° W)
Crosby, Charles H (1831–) .. 191

USA, New York, Cattaraugus, East Randolph

(42.1728° N, 78.9478° W)
Benedict, Samuel Joseph (1833–)..... 216

USA, New York, Cattaraugus, Great Valley

(42.2144° N, 78.6367° W)
Estabrook, Charles Gouder (1850–1880) 238

USA, New York, Cattaraugus, Randolph

(42.162° N, 78.9753° W)
Benedict, Samuel Joseph (1833–)..... 215

USA, New York, Cayuga, Auburn

(42.9317° N, 76.5661° W)
Sears, Lovilly (1786–1856).... 88

USA, New York, Cayuga, Cato

(43.1681° N, 76.573° W)
Bristol, Mary Ann (1808–) ... 129

USA, New York, Cayuga, Conquest

(43.1211° N, 76.6484° W)
Coleman, Caroline H "Carrie" (1847–) 226

USA, New York, Cayuga, Genoa

(42.6678° N, 76.5361° W)
Sears, Hannah (1825–)..... 230
Sears, Henry Williams (1833–1879) 235

USA, New York, Cayuga, Locke

(42.6606° N, 76.4311° W)
Tyler, Sally Maria (1823–1890) 105

USA, New York, Cayuga, Sterling

(43.3258° N, 76.6453° W)
St. Douglass, Mills (1834–).. 225

USA, New York, Cayuga, Venice

(42.7156° N, 76.5466° W)
Sears, Albert Edgar (1832–1903) 234

USA, New York, Chautauqua

(42.3015° N, 79.4125° W)
Partridge, Edward Turner (1799–1887) 171
Sears, Abijah (1774–1839).... 35
Sears, Polly Matilda (1805–1853) 171
Shepardson, Laurilla (1818–1850) 172

USA, New York, Chautauqua, Arkwright

(42.4069° N, 79.2367° W)
Crawford, Mary (1801–)..... 129
Rider, Robert Delos (1799–1867) 118

USA, New York, Chautauqua, Carroll

(42.037° N, 79.1217° W)
Sears, Eli (1800–1854) 136

USA, New York, Chautauqua, Ellington

(42.2167° N, 79.1081° W)
Sears, Ambrose (1793–1843)24, 201
Sears, Louisa (1824–1894).. 202

USA, New York, Chautauqua, Gerry

(42.1933° N, 79.2489° W)
Partridge, Edward Turner (1799–1887)171
Sears, Hiram (1811–1904)...172
Sears, Polly Matilda (1805–1853)171
Shepardson, Laurilla (1818–1850)172

USA, New York, Chautauqua, Jamestown

(42.097° N, 79.2353° W)
Sears, Hiram (1811–1904)...172
Sears, Polly Matilda (1805–1853)171

USA, New York, Chautauqua, Poland

(42.1292° N, 79.1212° W)
Sears, Louisa (1824–1894) ..202

USA, New York, Chautauqua, Villenova, prob

Rider, James W (1807–1871)118

USA, New York, Chemung, Elmira

(42.0898° N, 76.8078° W)
Hoyt, Elizabeth H (1829–1886)193

USA, New York, Chemung, Elmira, Woodlawn Cemetery

Hoyt, Elizabeth H (1829–1886)193

USA, New York, Cortland, Cortland

(42.6012° N, 76.1805° W)
Gidley, Mary (1825–1900)....127
Sears, Odell Marvin (1815–1892)127

USA, New York, Cortland, Cortlandville

(42.5923° N, 76.1569° W)
Sears, Odell Marvin (1815–1892)127

USA, New York, Cortland, Homer

(42.637° N, 76.1788° W)
Sears, Francis (1808–1870) .126

USA, New York, Cortland, Truxton

(42.7119° N, 76.0289° W)
Sears, Odell Marvin (1815–1892)127

USA, New York, Delaware, Colchester

(42.1603° N, 75.0778° W)
Sears, David F (1791-1872).132

USA, New York, Delaware, Colchester, perh

Pine, Sally (1792-1859)132

USA, New York, Delaware, Delhi

(42.2781° N, 74.916° W)
Howe, Augusta R (1833-1880)
.....234

USA, New York, Dutchess

(41.7645° N, 73.7472° W)
Jones, Ebenezer (1799-1886) 50
La Du, Brinkerhoff (1808-1883)
.....218
Marvin, Laura (1796-1871)..116
Raymond, Harriet Almira (1819-)
.....187
Sears, Sarah (1767-1860)...119

USA, New York, Dutchess, Milltown

Sears, Heman (1767-1817) .. 28

USA, New York, Dutchess, Milltown, Old Cemetery

Barnum, Patty M (1793-1815)
.....186

USA, New York, Dutchess, North East

(41.9482° N, 73.5462° W)
Sears, Philip (1759-1831) 65, 84

USA, New York, Dutchess, North East, perh

Sears, Isaac (1763-)... 65, 89

USA, New York, Dutchess, perh

Raymond, Lewis Napoleon
(1788-1852).....120

USA, New York, Dutchess, Southeast

Sears, Isaac (1786-1868).... 73, 144
Sears, Mary (1791-1821) 29, 145
Sears, Polly M (1800-1873) .195

USA, New York, Erie

(42.755° N, 78.7849° W)
Sears, Frank (1878-1971) ...280

USA, New York, Erie, Buffalo

(42.8865° N, 78.8784° W)
Crosby, Sarah (1800-1869).192
Parish, Roxcellana (1838-1867)
.....194
Sears, Francis Augustus "Frank"
(1833-)... 193, 194

USA, New York, Erie, Buffalo, Ward 24

Price, Anna Crosby..... 250

USA, New York, Erie, Eden

(42.6523° N, 78.897° W)
Sears, Frank (1878-1971) ... 280

USA, New York, Foster

Howard, Martha (1793-1854)
..... 120

USA, New York, Herkimer Co, Litchfield, prob

Rider, Anna (1794-1866) 117

USA, New York, Herkimer Co, Winfield, perh

Spencer, Lucy (1801-)... 118

USA, New York, Herkimer Co, Winfield, prob

Rider, Rebecca (1801-1844) 118

USA, New York, Herkimer, Litchfield

(42.9776° N, 75.1507° W)
Rider, Charles Paine (1796-1875).....117
Rider, James W (1807-1871)118
Rider, Rebecca (1801-1844) 118
Rider, Robert Delos (1799-1867)
..... 118
--Rider, Susan (1821-)...118
--Rider, Susannah (1813-)... 118
Sears, Thankful (1775-1808) 71, 128
Smith, Amanda Maria (1804-1876)..... 129

USA, New York, Herkimer, Litchfield, perh

Cole, Levi (1797-)... 118
Rogers, Almira (1834-)... 118

USA, New York, Herkimer, Winfield

(42.8973° N, 75.1663° W)
Rider, Robert Delos (1799-1867)
..... 118
Rider, Zadoc(k) (1752-1827)
..... 117
Sears, Naomi (1764-1846) ... 70, 117

USA, New York, Herkimer, Winfield, North Winfield

Sears, Naomi (1764-1846) .. 117

USA, New York, Jefferson, Henderson

(43.8469° N, 76.1822° W)
Rider, Charles Paine (1796-1875)..... 117

USA, New York, Jefferson, Henderson, perh

Penny, Rebecca (1800-)... 117

USA, New York, Kings, Brooklyn

(40.65° N, 73.95° W)
Sears, George (1812-1882). 145

USA, New York, Madison, Cazenovia

(42.9301° N, 75.8527° W)
Sears, Ann M (1800-1874) .. 126

USA, New York, Madison, De Ruyter

(42.7585° N, 75.8868° W)
Marvin, Betsy (1778-1854) .125
Mitchell, Susan Ann (1801-1890)
..... 126
Nye, Mary (1809-1854) 126
Sears, Eleazar H (1771-1855)
.....70, 125
Sears, George S (1804-1858)
..... 126
Sears, Odell Marvin (1815-1892)
..... 127
Sears, Stephen Gregory (1798-1868)..... 125, 126

USA, New York, Madison, Eaton

(42.8497° N, 75.6122° W)
Sears, Charles (1800-1870) .37, 230
Sears, Erastus (1809-)... 38
Sears, Hart Boughton (1807-1885).....38, 232
Sears, James (1797-1835)... 37, 227
Sears, Mary Ann (1805-1839)
.....38, 231

USA, New York, Madison, Hamilton

(42.827° N, 75.5446° W)
Holcomb, Laura L (1817-1903)
..... 104

USA, New York, Madison, Lebanon

(42.7814° N, 75.6481° W)
Sears, Hiram (1811-1904) .. 172

USA, New York, Milltown

Sears, Seth (1736-1809) 61, 70
Sears, Thankful (1734-1772) 61, 68

USA, New York, Monroe, Clarkson

(43.2331° N, 77.9278° W)
Clark, William..... 274
Sears, Ruhamah (1801-1868)
..... 15, 51
Sherwood, Jones Ebenezer
(1831-1864).....53, 261

USA, New York, Monroe, Rochester, Ward 6

Benedict, Enomel (ca.1855-)258

Benedict, John Barnum
(ca.1820-) 257
Brush, Ann Elizabeth (1827-)
..... 257

**USA, New York,
Montgomery County,
Amsterdam**

(42.9387° N, 74.1882° W)
Jones, Catherine L (1834-1901)
..... 50

**USA, New York, New York,
Manhattan**

(40.7834° N, 73.9663° W)
Hadden, Susan (1815-1845) 137
McKnight, Robert..... 101
Sears, Alonzo Elmore (1825-
1862) 190
Young, Thomas Sears (1813-
1904) 149

**USA, New York, New York,
Manhattan, Ward 16**

Sears, Herman Barnum (1815-
1885) 187

USA, New York, Niagara

(43.3239° N, 78.7939° W)
Dutcher, Harriet E "Hattie"
(1857-1882) 286
Hyde, Ray Sears (1886-1977)
..... 270
Sears, Caroline "Carrie" (1872-
1951) 278
Sears, Ruhamah (1801-1868)
..... 15, 52
Sherwood, Elam G (1827-1912)
..... 53, 260
Sherwood, May (1866-1872) 267
Sherwood, Noah Schuyler (1786-
1873) 52

**USA, New York, Niagara
County, Olcott**

(43.3378° N, 78.7148° W)
DuBois, Clarissa (1807-1873) 57
Sears, Haman Hannibal (1839-
1879) 290

**USA, New York, Niagara
County, Somerset**

(43.3475° N, 78.5561° W)
Sears, Ruhamah (1801-1868) 52
Sherwood, Abel Sears (1823-
1902) 259
Sherwood, Angeline (1844-
1914) 270
Sherwood, Elam G (1827-1912)
..... 260
Sherwood, James Launey (1838-
1914) 54
Sherwood, John (1834-1909)
..... 264
Sherwood, Noah Schuyler (1786-
1873) 52

**USA, New York, Niagara
County, Wilson**

(43.3098° N, 78.8262° W)
Sears, Hester Marie (1836-1918)
..... 58, 287

**USA, New York, Niagara,
Cambria, North Ridge
Cemetery**

Wilson, Henry O (1875-1963)
..... 289

**USA, New York, Niagara,
Hartland**

(43.24° N, 78.5764° W)
Hibbard, Frances Marion (1830-
1887) 262
Sears, Caroline "Carrie" (1872-
1951) 278
Sherwood, Edie (1877-1974)
..... 267, 268
Sherwood, Elam G (1827-1912)
..... 53, 260
Sherwood, George C (1861-
1931) 263
Sherwood, Herbert Leon (1863-
1931) 267
Sherwood, Jones Ebenezer
(1831-1864) 262
Sherwood, Mary Celinda (1857-
1939) 263
Sherwood, May (1866-1872) 267
Sherwood, Myron (1836-1904)
..... 266
Sherwood, Noah Schuyler (1786-
1873) 53
Sherwood, Ora A "Orrie" (1856-
1925) 262
Spalding, Emily Cozzens (1838-
1918) 266, 267

**USA, New York, Niagara,
Hartland Township**

(43.24° N, 78.5764° W)
Sherwood, Edie (1877-1974) 268
Sherwood, Myron (1836-1904)
..... 266
Spalding, Emily Cozzens (1838-
1918) 267

**USA, New York, Niagara,
Hartland, perh**

Dewhurst, Susannah (1831-)
..... 260
Sherwood, Elam G (1827-1912)
..... 260

**USA, New York, Niagara,
Lockport**

(43.1706° N, 78.6903° W)
Christy, Charles Wesley (1864-
1948) 284
Sears, Burt (1869-1952) 276
Sears, Clara Marilla "Marilla"
(1868-1938) 291
Sears, Frank (1878-1971)... 281

**USA, New York, Niagara,
Lockport, Ward 4**

Sears, Caroline "Carrie" (1872-
1951) 278
Sears, Isaac (1833-1914) 273
Sweet, Hannah (1835-1919) 274

**USA, New York, Niagara,
Lockport, Ward 5**

Sears, Caroline "Carrie" (1872-
1951) 278

**USA, New York, Niagara,
Lockport, Ward 8**

Sears, Caroline "Carrie" (1872-
1951) 278
Sweet, Hannah (1835-1919) 274

**USA, New York, Niagara,
Newfane**

(43.2867° N, 78.7103° W)
Brandt, Rosa M (1872-1948) 277
Christy, Eliza J (1854-<1860)
..... 282
Christy, Elizabeth Ann (1858-
1941) 283
Christy, James (1830-) 282
Christy, Jennie Lynd (1861-
1919) 283
Christy, Sara Ella (1856-1905)
..... 282, 283
Mandaville, Ina L (ca.1880-
1947) 280
Moore, Ann Eliza (1809-1891) 55
Sears, Abigail (1829-) ... 55, 271
Sears, Ann Eliza (1857-1892)
..... 274
Sears, Burt (1869-1952) 276,
277
Sears, Caroline "Carrie" (1872-
1951) 277, 278
Sears, Evaline "Eva" (1873-
1949) 278, 279
Sears, Frank (1878-1971) ... 280
Sears, Haman (1807-1838) . 16,
55
Sears, Haman Hannibal (1839-
1879) 58, 290
Sears, Heman (1807-1880) . 16,
57
Sears, Heman (1861-1885) . 275
Sears, Isaac (1776-1848) 13
Sears, Isaac (1833-1914) 55,
272, 273
Sears, Jennie H (1864-1920) 275
Sears, John Sylvester (1867-
1958) 276
Sears, Marietta "Etta" (1859-
1932) 274, 275
Sears, Mary Ann (1835-) 282
Sears, Sophia (1829-1913).. 58,
285
Sears, Wilson "Willie" (1876-
1928) 279, 280
Sherwood, Herbert Leon (1863-
1931) 267
Sherwood, Myron (1836-1904)
..... 266

Siemdorf, Anna Mary (ca.1882–1959).....281
 Smith, Ammi (1824–1909)...285
 Smith, Oscar H (1865–).....286
 Smith, Silas P (1851–1896)..285
 Spalding, Emily Cozzens (1838–1918)..... 266, 267
 Sweet, Hannah (1835–1919) 273, 274

USA, New York, Niagara, Newfane, Corwin Cemetery

Sears, Wilson "Willie" (1876–1928).....279

USA, New York, Niagara, Newfane, perh

DuBois, Clarissa (1807–1873) 57
 Sears, Hester Marie (1836–1918) 58, 287
 Sears, John William (1834–1843) 58
 Sears, Mary Ann (1835–)56, 281
 Sears, Polly (1830–4713 BC) 58, 286
 Sears, Sophia (1829–1913).. 58, 284

USA, New York, Niagara, Niagara

(43.1153° N, 78.9812° W)

Sherwood, George C (1861–1931).....263
 Sherwood, Jones Ebenezer (1831–1864).....262
 Sherwood, Lewis Hibbard (1859–1862).....263
 Sherwood, Mary Celinda (1857–1939).....263
 Sherwood, Ora A "Orrie" (1856–1925).....262

USA, New York, Niagara, Olcott

(43.3378° N, 78.7148° W)

DuBois, Clarissa (1807–1873) 58
 Sears, Haman (1807–1838). 16, 55
 Sears, Haman Hannibal (1839–1879).....291
 Sears, Heman (1807–1880) .. 57
 Sears, Isaac (1776–1848)..... 13
 Sears, Mary Ann (1835–).....282
 Woods, Polly (1780–1858) 14

USA, New York, Niagara, Somerset

(43.3475° N, 78.5561° W)

Hibbard, Frances Marion (1830–1887).....262
 Sears, Ruhamah (1801–1868)52
 Sherwood, Angeline (1844–1914)..... 54, 269, 270
 Sherwood, Mary Celinda (1857–1939).....263
 Sherwood, Myron (1836–1904) 53, 265, 266

Sherwood, Noah Schuyler (1786–1873)..... 52, 53
 Sherwood, Ora A "Orrie" (1856–1925).....262

USA, New York, Niagara, Wilson

(43.3098° N, 78.8262° W)

van Wagoner, Kittie (1859–1934)288

USA, New York, North Hartland

Smith, Ammi (1824–1909) ..285

USA, New York, Oneida, Cassville

(42.9458° N, 75.2547° W)

Rider, Charles Paine (1796–1875)..... 117

USA, New York, Onondaga County, Onondaga

(43.2291° N, 76.1427° W)

Sears, Daniel Deliance (1831–1864).....205
 Sears, Marcus (1833–1859) .205
 --Sears, Prudence M (1834–1860).....206
 Spalding, Emily Cozzens (1838–1918).....266

USA, New York, Onondaga County, Clay

(43.1858° N, 76.1728° W)

Sears, Daniel Deliance (1831–1864).....205

USA, New York, Onondaga County, Fayetteville

(43.0298° N, 76.0043° W)

Sears, Caroline Miranda (1848–1934).....238

USA, New York, Onondaga County, Van Buren

(43.1136° N, 76.3025° W)

Betts, Elizabeth (1796–1880)198

USA, New York, Onondaga County, Warners

(43.0853° N, 76.3294° W)

Cook, Phebe (1819–1852) ...225

USA, New York, Onondaga, Baldwinsville

(43.1587° N, 76.3327° W)

Bell, Ann (1799–1853)204
 Betts, Elizabeth (1796–1880)198
 Nichols, Hannah (1825–1878)200
 Sears, Adelaid (1836–1858) .206
 Sears, Ahiram (1795–1856) ..24, 203
 Sears, Arza (1790–1859)24, 197

Sears, Daniel (1762–1840)....23
 Sears, Daniel Deliance (1831–1864).....205
 Sears, John (1772–1839)32
 Sears, Marcus (1833–1859) .205
 Smith, Jane Elizabeth (1824–1904).....199

USA, New York, Onondaga, Baldwinsville, perh

Bell, Ann (1799–1853)204
 Wilcox, Emily Hopkins (1831–1859).....205

USA, New York, Onondaga, Baldwinsville, Sears Cemetery

Sears, Abijah (1798–1837)24

USA, New York, Onondaga, Camillus

(43.0392° N, 76.3041° W)

Sears, Adelaide (1805–1876) .34
 Sears, Betsy (1802–1819)34
 Sears, Eleazar (1801–1841)...89
 Sears, George (1823–1866)..42, 244
 Sears, Hannah (1797–1898) .34, 219, 220
 Sears, John (1772–1839) 21, 32
 Sears, John (1821–1857)35, 224
 Sears, Knowles (1800–1820) .34
 Sears, Phebe (1823–)35
 Sears, Susanna (1793–1808) .33
 Sears, Tamma (1795–1864) .33, 217

USA, New York, Onondaga, Camillus, perh

Kingsley, Algernon S (1839–)223
 Kingsley, Cyrus (1830–)222
 Kingsley, Edward (1828–1858)222
 Kingsley, Emily (1823–)222
 Kingsley, Knowles (1825–1827)222
 Kingsley, Oliver (1816–)221
 Kingsley, Ulysses (1834–1836)223
 Lamerson, Betsy (1819–)218
 Lamerson, George (1833–1849)219
 Lamerson, Jacob (1817–1860)218
 Lamerson, John Sears (1823–1862).....218
 Lamerson, Mary (1826–)218
 Lamerson, Matilda (1831–)..219
 Lamerson, Sears (1828–1866)218
 Lamerson, Susan (1814–1904)218
 Lamerson, Tamma (1821–)..218
 Lamerson, Wayne (1836–)...219
 Lusk, Phebe (1784–1855).....35

- Townsend, Mary (1772-1819) 33
 Wheaton, Sarah (1806-1846) 89
- USA, New York,
 Onondaga, Clay, Pine
 Plains Cemetery**
 Wilcox, Emily Hopkins (1831-
 1859) 205
- USA, New York,
 Onondaga, Lysander**
 (43.2064° N, 76.4594° W)
 Bell, Ann (1799-1853)..... 204
 Sears, Ahiram (1795-1856). 204
 Sears, Daniel Deliance (1831-
 1864) 205
 Sears, Marcus (1833-1859). 205
- USA, New York,
 Onondaga, Lysander,
 Myrtle Grove Cemetery**
 Sears, Adelaid (1836-1858) 206
 Sears, Ahiram (1795-1856). 203
 Sears, Alfred (1789-1856) 24
 Sears, Marcus (1833-1859). 205
 --Sears, Prudence M (1834-
 1860) 206
- USA, New York,
 Onondaga, Old Sorrels
 Hill**
 Sears, James (1822-1923).. 200
- USA, New York,
 Onondaga, Syracuse,
 Oakwood Cemetery**
 Sears, Caroline Miranda (1848-
 1934) 238
- USA, New York,
 Onondaga, Syracuse,
 Ward 5**
 Sears, Caroline Miranda (1848-
 1934) 238
- USA, New York,
 Onondaga, Van Buren**
 (43.1136° N, 76.3025° W)
 Betts, Elizabeth (1796-1880)
 198
 Kingsley, Algernon S (1839-)
 223
 Kingsley, Cyrus Hills (1789-
 1878) 220, 221
 Kingsley, Polly (1819-1876) 221
 La Du, Brinkerhoff (1808-1883)
 218
 Nichols, Hannah (1825-1878)
 200
 Sears, Arza (1790-1859) 198
 Sears, Daniel (1762-1840)... 20,
 23
 Sears, Hannah (1797-1898). 34,
 220
 Sears, James (1822-1923). 199,
 200
 Sears, Rufus (1819-1876).. 198,
 199
- USA, New York,
 Onondaga, Van Buren,
 District 02**
 Sears, Rufus (1819-1876)... 199
- USA, New York,
 Onondaga, Van Buren,
 E.D. 2**
 Sears, Rufus (1819-1876)... 199
- USA, New York,
 Onondaga, Van Buren,
 perh**
 Betts, Elizabeth (1796-1880)
 198
 Smith, Jane Elizabeth (1824-
 1904) 199
- USA, New York,
 Onondaga, Van Buren,
 Sorrell Hill Cemetery**
 Sears, Rufus (1819-1876)... 198
- USA, New York,
 Onondaga, Warners**
 (43.0853° N, 76.3294° W)
 La Du, Brinkerhoff (1808-1883)
 218
 Lamerson, Susan (1814-1904)
 218
 Sears, Tamma (1795-1864) 217
- USA, New York,
 Onondaga, Warners,
 Warner's Rd Cemetery**
 Lamerson, John Harrison (1785-
 1863) 218
- USA, New York, Ontario
 County, Seneca**
 (42.8367° N, 77.0756° W)
 Sears, James (1788-1878).. 179
- USA, New York, Ontario,
 Canandaigua**
 (42.8742° N, 77.2881° W)
 Parish, Roxcellana (1838-1867)
 194
- USA, New York, Ontario,
 Phelps**
 (42.9576° N, 77.0575° W)
 Brush, Knowles Sears (1811-
 1882) 253
 Crosby, Deborah (1790-1849)
 180
 Meeker, Elizabeth (1814-1881)
 253
 Sears, Lewis (1795-1868)... 192
 Warner, Harriet Elizabeth (1832-
 1913) 185
- USA, New York, Ontario,
 Phelps, perh**
 Brush, Benjamin S (1845-). 254
 Brush, Caroline (1843-)... 254
 Brush, Charity (1857-)... 254
- Brush, Cornelia (1843-)...254
 Brush, James S (1851-)... 254
 Brush, Mary E (1838-)...253
 Brush, Sarah E (1835-)... 253
- USA, New York, Ontario,
 Seneca**
 (42.8367° N, 77.0756° W)
 Sears, Gould Boughton (1811-
 1900)183
- USA, New York, Ontario,
 Seneca Castle**
 (42.8869° N, 77.0964° W)
 Sears, James (1788-1878)... 80,
 179
- USA, New York, Orleans**
 (43.3682° N, 78.2288° W)
 Sears, Clarke Crosby (1827-
 1915)184
- USA, New York, Orleans,
 Knowlesville**
 (43.2419° N, 78.3108° W)
 Sears, Jared (1779-1828).... 76,
 160
- USA, New York, Orleans,
 Medina**
 (43.2201° N, 78.387° W)
 Smith, Silas (1801-1880)129
- USA, New York, Orleans,
 Medina, perh**
 McCracken, Minerva (1804-
 1830)129
- USA, New York, Oswego**
 (43.2462° N, 76.139° W)
 Cole, Amanda (1799-1871)... 97
 Sears, Nelson (1798-1881)... 96
- USA, New York, Oswego
 County, Pennellville**
 (43.2825° N, 76.2708° W)
 Millard, Mary Ann (1807-1876)
107
 Sears, Zachariah Paddock
 (1806-1888).....107
- USA, New York, Oswego
 County, Volney**
 (43.3428° N, 76.3581° W)
 Cole, Amanda (1799-1871)... 97
 Sears, Marietta (1809-1896). 99
 Sears, Nelson (1798-1881)... 96
- USA, New York, Oswego,
 Fulton**
 (43.3229° N, 76.4172° W)
 Foster, Anna (1779-1863) 96
 Sears, Luther (1774-1857) ... 96
 Sears, Marietta (1809-1896). 99
- USA, New York, Oswego,
 Pennellville**
 (43.2825° N, 76.2708° W)

Sears, Zachariah Paddock
(1806-1888).....107

**USA, New York, Oswego,
Schroepfel**

(43.2626° N, 76.2794° W)

Sears, Zachariah Paddock
(1806-1888).....107

**USA, New York, Oswego,
Volney**

(43.3428° N, 76.3581° W)

Foster, Anna (1779-1863).... 96
Sears, Ann Maria (1813-1847)
..... 99
Sears, Luther (1774-1857).. 66,
96
Sears, Nelson (1798-1881)... 96
Sears, Zachariah Paddock
(1806-1888).....107

USA, New York, Otsego

(42.6337° N, 75.0354° W)

Crosby, Charles 67

**USA, New York, Otsego,
Richfield**

(42.8572° N, 75.0544° W)

Rider, Rebecca (1801-1844) 118

USA, New York, perh

Raymond, Enoch (1792-)120
Raymond, Harvey (1790-)...120
Raymond, Lorenzo (1802-)...121
Raymond, Matilda (1800-)...121
Sears, David (1761-1842)65, 87
Sears, James (1839-)135
Sears, Louisa (1824-1894)..201
--Sears, Ruth (1792-1876)..201

USA, New York, Putnam

(41.4314° N, 73.7464° W)

Crosby, James (1763-1833). 67,
111
Crosby, Nelson (ca.1817-1899)
.....167

**USA, New York, Putnam,
Brewster**

(41.3973° N, 73.6171° W)

Crosby, Eber (1792-1836)... 77,
167
Haviland, Charity (1750-1836)
..... 18

**USA, New York, Putnam,
Brewster Hill**

(41.424° N, 73.6043° W)

Perry, Nehemiah (1802-1873)
.....196

**USA, New York, Putnam,
Carmel**

(41.4301° N, 73.6801° W)

Bull, Hanna (1769-1850).....131
Sears, Archibald (1780-1864)
..... 72, 140
Sears, Eli (1768-1800).. 72, 131

Sears, Thomas Baldwin (1773-
1855)..... 72, 133

**USA, New York, Putnam,
Milltown**

Sears, Seth Jr (1769-1819) ..70,
121

**USA, New York, Putnam,
Patterson**

(41.5136° N, 73.6067° W)

Crosby, Reuben (1735-1819).67
Crosby, Tertullus (1775-1874)
..... 67, 112
Haviland, Richard Towner (1829-
1908)..... 142
Perry, James A (1821-)..... 190
Perry, Mary M (1832-1883) .196
Perry, Nehemiah (1802-1873)
.....195, 196
Sears, Herman Barnum (1815-
1885).....187
Sears, Polly M (1800-1873) ..81,
195

**USA, New York, Putnam,
Southeast**

(41.4054° N, 73.6001° W)

Baldwin, Deborah (1749-1828)
.....72
Barnum, Patty M (1793-1815)
.....186
Boardman, Maria (1800-1888)
.....132
Crane, Sarah E (1818-).....178
Crosby, Eber (1792-1836)....77,
167
Crosby, Sarah (1800-1869).192
Northrop, Harriet (1824-1911)
.....189
Northrop, Mary Jane (1813-)182
Sears, Alonzo Elmore (1825-
1862)..... 190
Sears, Ann M (1800-1874) ..126
Sears, Archibald (1780-1864)
..... 73, 140, 142
Sears, Archibald (1802-1893)
.....137
Sears, David F (1791-1872) 132
Sears, Deborah (1789-) 73, 146
Sears, Ebenezer A (1798-1868)
..... 123
Sears, Eleazar H (1771-1855)
..... 125
Sears, Eli (1768-1800).. 72, 130
Sears, Eli (1800-1854).....136
Sears, Elizabeth (1775-1790) 72
Sears, Enoch Hamlin (1761-)70,
114
Sears, George (1812-1882).145
Sears, George S (1804-1858)
..... 126
Sears, Heman (1767-1817)...28
Sears, Herman Barnum (1815-
1885)..... 186
Sears, Isaac (1821-1823)....146
Sears, Jacob Brush (1823-1893)
.....189

Sears, James (1778-1857)...72,
133, 134

Sears, James (1788-1878)..180
Sears, Lewis (1807-1877)...124

Sears, Martha Matilda (1821-
1866).....188
Sears, Mary E "Polly" (1830-
1916)..... 142
Sears, Mary E (1814-1860) .149
Sears, Naomi (1802-1844)..123
Sears, Peter H (1800-1870) 123
Sears, Roxanna (1805-1875)
..... 124

Sears, Ruhamah (1817-).....122
Sears, Sally B (1792-) ...73, 148
Sears, Sarah (1767-1860)....70,
119

Sears, Seth (1736-1809)70
Sears, Seth A (1810-1880) .124
Sears, Sophia (1784-1869) ..73,
143

Sears, Stephen Gregory (1798-
1868).....125
Sears, Susannah (1814-1830)
..... 122

Sears, Susie (1816-1886) ...145
Sears, Thankful (1775-1808) 71,
128

Sears, Thomas (1745-1804).61,
72

Sears, Thomas (1836-1906) 143
Sears, Thomas Baldwin (1773-
1855).....72, 133

Sears, Thomas Baldwin (1789-
1871).....131
Sears, William (1775-1864).169

**USA, New York, Putnam,
Southeast, 72-8-16**

Sears Burying Ground

Sears, Polly M (1800-1873).195

**USA, New York, Putnam,
Southeast, Danbury or**

Sears, Eleazar H (1771-1855)
.....70, 124

**USA, New York, Putnam,
Southeast, Milltown**

Cemetery

Andrews, Ruhamah (1782-1813)
..... 123

Crane, Eunice (1754-1839) ...80
Sears, Comfort (1751-1827) .79

Sears, Eunice (1784-1858)..177
Sears, Isaac (1786-1868) ...144

Sears, Isaac (1821-1823) ...146
Sears, Knowles (1738-1817) .17

Sears, Mary (1791-1821)....145
Sears, Mary E (1814-1860) .149

Sears, Seth (1736-1809)70
Sears, Seth Jr (1769-1819) .121

Young, Thomas Sears (1813-
1904)..... 149

**USA, New York, Putnam,
Southeast, Milltown**

Cemetery, 35-11-17

Sears, David H (1794-1830)..46

USA, New York, Putnam, Southeast, perh
 Baldwin, Deborah (1749-1828) 72
 Bivens, Roxanna (1803-1831) 137
 Brush, Mary A (1796-1872). 188
 Craft, (1785-)..... 148
 Crosby, Elijah (1792-) 179
 Ludington, (1785-)..... 147
 Marvin, Betsy (1778-1854) . 125
 Munsell, Lucretia (1808-).... 140
 Paddock, Eunice (1792-).... 122
 Sears, Betsy (1784-1854)... 115
 Sears, Caroline (1816-1857)138
 Sears, Deborah (1807-1840)138
 Sears, Fannie Baldwin (1832-1902) 142
 Sears, Francis (1808-1870). 126
 Sears, Kate (1834-1892) 142
 Sears, Lewis (1790-1860)... 115
 Sears, Melanthe (1816-)..... 138
 --Sears, Polly (1814-)..... 124
 Sears, Ruth (1786-) 115
 Sears, Sally (1788-1858).... 115
 Sears, Sally (1815-)..... 138
 Sears, Seth Jr (1769-1819).. 70, 121
 Sears, Smith (1792-1862) .. 116
 Sears, Thomas (1804-1850) 137
 Sherwood, Mehitabel S (1776-1824) 136
 Smith, (1760-) 115
 Smith, Amanda Maria (1804-1876) 129
 Smith, Nathaniel (1799-1855) 129
 Smith, Orrin Gazebe (1797-1880) 129
 Smith, Seth (1795-1801).... 129
 Smith, Seth Sears (1806-1884) 130
 Smith, Silas (1801-1880).... 129
 Young, Archibald (1780-).... 143
 Young, Ezra (1788-)..... 148

USA, New York, Putnam, Southeast, prob
 Sears, Naomi (1764-1846)... 70, 116

USA, New York, Putnam, Southeast, Sears Burying Gd
 Baldwin, Deborah (1749-1828) 72

USA, New York, Putnam, Southeast, Sears Burying Gd, 69-10-24
 Sellick, Polly (1798-1868) ... 142

USA, New York, Putnam, Southeast, Sears Burying Ground
 Lewis, Sally Betsy (-1858) .. 133
 Sears, Archibald (1780-1864) 140

Sears, Fannie Baldwin (1832-1902) 142
 Sears, Thomas (1745-1804) . 72

USA, New York, Putnam, Southeast, was Dutchess
 Crosby, Deborah (1790-1849) 180
 Rider, Anna (1794-1866).... 117
 Rider, Zadoc(k) (1752-1827) 117
 Sellick, Polly (1798-1868)... 142

USA, New York, Saratoga
 (43.1059° N, 73.8677° W)
 Howes, Mary (1785-1874) .. 115
 Jones, Emeline (1836-1839) . 50
 Jones, Mary L (1846-1846) ... 50
 Jones, Wesley (1832-1840)... 50
 Sears, Alexander (1782-1828) 115
 Sears, Major (1809-1828)..... 89

USA, New York, Saratoga, Ballston
 (42.9548° N, 73.879° W)
 Sears, Alexander (1782-1828) 115

USA, New York, Saratoga, Ballston Spa
 (43.0009° N, 73.849° W)
 Jones, Ebenezer (1799-1886) 50
 Jones, Emeline (1836-1839) . 50
 Jones, Mary L (1846-1846) ... 51
 Jones, Matilda (1822-1914) .. 50
 Jones, Rufus (1823-1874).... 50
 Jones, Wesley (1832-1840)... 50
 Sears, Angeline (1799-1864) 15, 49
 Sears, Isaac (1803-1834) 89

USA, New York, Saratoga, Crapo Cemetery
 Howes, Mary (1785-1874) .. 115
 Sears, Alexander (1782-1828) 115

USA, New York, Saratoga, Milton
 (43.0337° N, 73.8526° W)
 Sears, Abigail (1788-1859) ... 88
 Sears, David (1761-1842)65, 87
 Sears, David (1785-1855) 88
 Sears, Huldah (1798-)..... 88
 Sears, Lovilly (1786-1856).... 88
 Shearer, Alexander (1786-1845) 88

USA, New York, Saratoga, Milton, perh
 Blinn, Clarissa (1790-1868) .. 88
 Hoffman, William (1782-) 88

USA, New York, Saratoga, Milton, West Milton
 Sears, David (1761-1842) 87

USA, New York, Schenectady, Glenville
 (42.9292° N, 74.0525° W)
 Sears, Miles (1798-1870)170

USA, New York, Schoharie
 (42.591° N, 74.4394° W)
 Jones, Almira A (1820-1910) 50
 Jones, Angeline Sears (1827-1898) 50
 Jones, Catherine L (1834-1901) 50
 Jones, Matilda (1822-1914) .. 50

USA, New York, Schuyler
 (42.3898° N, 76.877° W)
 Sears, Thomas Baldwin (1789-1871)131

USA, New York, Schuyler, Hector
 (42.5006° N, 76.8728° W)
 Sears, David F (1791-1872).132
 Sears, Thomas Baldwin (1789-1871) 131, 132

USA, New York, Schuyler, Hector, Searsburg
 Sears, Thomas Baldwin (1789-1871)131

USA, New York, Schuyler, Searsburg
 Bull, Hanna (1769-1850)131
 Pine, Sally (1792-1859).....132
 Sears, David F (1791-1872).132

USA, New York, Seneca
 (42.786° N, 76.8287° W)
 Sears, Caroline (1816-1857) 138

USA, New York, Seneca County, Waterloo
 (42.9048° N, 76.8628° W)
 Sears, James (1778-1857)...134

USA, New York, Seneca, Covert
 (42.5753° N, 76.6839° W)
 Sears, Thomas Baldwin (1789-1871)132

USA, New York, Seneca, Seneca Falls
 (42.9106° N, 76.7966° W)
 Beebe, Capt Byron Crosby (1830-1905)251

USA, New York, Seneca, Tyre
 (42.9911° N, 76.8025° W)
 Sears, Caroline (1816-1857) 138
 Sears, James (1778-1857)...134
 --Sears, Phebe (1817-)135
 Sears, Smith (1841-)135

USA, New York, St Lawrence, Madrid
(44.6287° N, 74.8117° W)
Abernathy, Ursula (1810–1869) 91
Sears, Charles Andrew (1803–1855) 91
Sears, Elijah (1794–) 90

USA, New York, Steuben
(42.2642° N, 77.3854° W)
Sears, Alonzo (1827–1904)..202

USA, New York, Steuben, Cameron
(42.1992° N, 77.4067° W)
Sears, Alonzo (1827–1904)..202
Sears, Alonzo Elmore (1825–1862)190

USA, New York, Steuben, Sherer Cemetery
Sears, Alonzo (1827–1904)..202

USA, New York, Suffolk, West Farms
Smith, William (1770–1857).128

USA, New York, Sullivan
(41.7153° N, 74.765° W)
Sears, Patty Maria (1817–) ..172

USA, New York, Sullivan, Bridgeville
Hoyt, Walter (1810–1888) ...173
Sears, Patty Maria (1817–) ..173

USA, New York, Sullivan, Fallsburg
(41.732° N, 74.6017° W)
Sears, Thirza (1779–1861)...169
Sears, William (1775–1864).170

USA, New York, Sullivan, Mountain Dale
(41.6894° N, 74.5317° W)
Sears, Thirza (1779–1861)...168
Sears, William (1775–1864).169

USA, New York, Sullivan, Neversink
(41.8472° N, 74.6195° W)
Sears, Thirza (1779–1861)... 80, 168
Sears, William (1775–1864).169

USA, New York, Sullivan, Thompson
(41.647° N, 74.6766° W)
Bowers, Sally P (1800–1833)170
Misner, Catherine (1820–1895)170
Sears, Clarissa (1801–1824) 170
Sears, Patty Maria (1817–) ..173
Sears, Thirza (1779–1861)...169
Sears, William (1775–1864).169

USA, New York, Sullivan, Thompson, Bridgeville
Hoyt, Walter (1810–1888) ...173
Sears, Patty Maria (1817–) ..173

USA, New York, Sullivan, Thompson, perh
Hoyt, S M (1797–) 171

USA, New York, Tioga
(42.1668° N, 76.3029° W)
Sears, Martin Van Buren (1836–1903).....235

USA, New York, Tioga County, Newark
Sears, Hart Boughton (1807–1885).....233

USA, New York, Tioga County, Newark Valley
(42.2237° N, 76.1833° W)
Sears, Delphine Augusta (1842–1915).....236
Sears, Hart Boughton (1807–1885).....233
Williams, Cynthia Marie (1810–1885).....233

USA, New York, Tioga County, North Spencer
Sears, John J (1831–) 228

USA, New York, Tioga County, Richford
(42.3556° N, 76.2011° W)
Holcomb, Laura L (1817–1903) 104
Judd, Lucy (1776–1841)..... 103
Sears, Dioclesian (1808–1905) 104
Sears, James (1776–1847) .. 102
Sears, Phillip (1812–1885)... 104
Tyler, Sally Maria (1823–1890) 105

USA, New York, Tioga, Candor
(42.2329° N, 76.3425° W)
Barager, Charles Fredrick Sr (1838–1891)..... 208
Barager, Judge Samuel (1794–1871)..... 208
Markell, Mary Jane (1846–1924) 209
Sears, Ruhamah (1796–1878) 24, 207

USA, New York, Tioga, Newark Valley
(42.2237° N, 76.1833° W)
Browne, Anna (–1856)36
Cargill, George (1802–1872) 103
Dean, Angeline (1829–1881) 235
Moore, Sophronia (1838–1902)236
Sears, Caroline Miranda (1848–1934).....238

Sears, Charles Williams (1830–1915)..... 234
Sears, Corydon Birch (1839–1905)..... 236
Sears, Delphine Augusta (1842–1915).....236
Sears, Frederic Jerome (1851–1863)..... 238
Sears, Hart Boughton (1807–1885).....38, 233
Sears, Henry (1823–) 230
Sears, Martin Van Buren (1836–1903).....235
Sears, Mary Ann (1805–1839) 231
Sears, Mary Ann (1843–1844)237
Sears, Oliver Williams (1845–>1916) 237
Williams, Cynthia Marie (1810–1885)..... 233

USA, New York, Tioga, Newark Valley, perh
Day, Mary O (1843–) 236
Moore, Sophronia (1838–1902)235
Rewey, Angeline (1829–)..... 232
Rewey, Martha Ann (1826–) 231
Rewey, Mary Augusta (1836–) 232
Spalding, Lucius Wells (1832–)237
Tabor, Clarissa (1801–)..... 230

USA, New York, Tioga, Nichols
(42.0205° N, 76.3765° W)
Sears, John J (1831–) 229

USA, New York, Tioga, Richford
(42.3556° N, 76.2011° W)
Judd, Lucy (1776–1841)..... 103
Rogers, Lucius D (1806–) 104
Sears, Dioclesian (1808–1905) 104
Sears, James (1776–1847) ...66, 102
Sears, Phillip (1812–1885).. 104, 105

USA, New York, Tompkins
(42.4514° N, 76.4747° W)
Hart, Louisa Celestia (1836–1898)..... 229

USA, New York, Tompkins County, Trumansburg
(42.5423° N, 76.6661° W)
Bull, Hanna (1769–1850) 131
Pine, Sally (1792–1859) 133
Sears, David F (1791–1872) 132

USA, New York, Tompkins, Danby
(42.3522° N, 76.4811° W)
Sears, David (1825–)..... 228
Sears, Egbert (1832–)..... 229

- Sears, Erastus (1821–1889) 228
 Sears, James (1797–1835)... 37, 227
 Sears, John J (1831–)... 228, 229
 Sears, Lucy (1800–1870) 39
 Sears, William (1827–) 228
- USA, New York, Tompkins, Danby, perh**
 Cartwright, Matilda (1801–). 228
 Sears, Isaac (1802–1872) 39
- USA, New York, Tompkins, Danby, West Danby**
 Sears, Erastus (1821–1889) 228
 --Sears, Sally A (1821–1872) 228
- USA, New York, Tompkins, Dryden**
 (42.4909° N, 76.2972° W)
 Reed, Helen C (ca.1837–)... 229
- USA, New York, Tompkins, Trumansburg**
 (42.5423° N, 76.6661° W)
 Sears, Thomas Baldwin (1789–1871) 131
- USA, New York, Ulster, Milton**
 (41.6597° N, 73.9575° W)
 Sears, Edward (1805–1875) .. 89
 Sears, Eleazar (1801–1841) .. 89
 Sears, Isaac (1803–1834) 89
 Sears, John (1807–1877) 89
 Sears, Major (1809–1828) 89
- USA, New York, Washington**
 (43.3201° N, 73.4306° W)
 Betts, Rial (1804–1887) 138
- USA, New York, Washington, Salem, North Salem, perh**
 Jarvis, Marietta (1814–1905) 243
- USA, New York, Wayne**
 (43.283° N, 77.0535° W)
 Sherwood, Mehitabel S (1776–1824) 136
- USA, New York, Wayne County, Huron**
 (43.2333° N, 76.8803° W)
 Sears, Elizabeth (1790–1880) 44
 Sears, Phebe (1796–1864) 19
- USA, New York, Wayne, Butler, South Butler, perh.**
 Overacre, (1812–)..... 138
- USA, New York, Wayne, Galen**
 (43.0676° N, 76.8802° W)
 Sears, James (1778–1857).. 134
- USA, New York, Wayne, Huron**
 (43.2333° N, 76.8803° W)
 Brush, James S (1851–)..... 254
 Brush, Joseph Bennett (1786–1858) 45
- USA, New York, Wayne, North Rose**
 (43.1856° N, 76.8928° W)
 Sears, Deborah (1807–1840) 138
- USA, New York, Wayne, perh**
 Gardner, Minerva (1812–)... 137
- USA, New York, Wayne, Red Creek**
 (43.2473° N, 76.7236° W)
 Sears, Mary E (1844–1875). 225
 Sears, Spencer L (1847–<1920) 225
- USA, New York, Wayne, Red Creek, perh**
 Cook, Phebe (1819–1852)... 225
- USA, New York, Wayne, Savannah**
 (43.0672° N, 76.76° W)
 Betts, Rial (1804–1887)..... 138
 Sears, Deborah (1807–1840) 138
- USA, New York, Wayne, South Butler**
 (43.1314° N, 76.7661° W)
 Sears, Melanthe (1816–)..... 138
- USA, New York, Wayne, Wolcott**
 (43.2206° N, 76.815° W)
 Cook, Phebe (1819–1852)... 225
 Sears, John (1821–1857)... 225
 Sears, Mary E (1844–1875). 225
 Sears, Spencer L (1847–<1920) 225, 226
- USA, New York, Westchester**
 (41.1536° N, 73.754° W)
 Sears, Desire (1778–1879)... 40
- USA, New York, Westchester, North Salem**
 (41.3347° N, 73.5717° W)
 Northrop, Francis B (1809–) 184
 Sears, Alonzo Elmore (1825–1862) 190
 Sears, Edwin Collins (1808–1866) 242
 Smith, Susan A (1829–)..... 190
- USA, New York, Westchester, Yonkers**
 (40.9312° N, 73.8987° W)
- Bolger, Mary A (1858–1908) 248
- USA, New York, Wyoming, Gainesville**
 (42.6409° N, 78.1339° W)
 Brownson, Isaac (1763–1832) 150
- USA, Ohio**
 (40.2083° N, 81.325° W)
 Green, Sarah O. (1839–) 223
 Sears, Heman (1818–1893) .145
 Sears, Isaac W (1816–1895) 139
- USA, Ohio, Ashtabula**
 (41.8901° N, 80.7559° W)
 Kingsley, Algernon S (1839–) 223
- USA, Ohio, Berlin Heights**
 Sears, Isaac (1786–1868).... 73, 144
- USA, Ohio, Coshocton, Bedford**
 (41.3931° N, 81.5365° W)
 Smith, William (1770–1857).128
- USA, Ohio, Lorain County, Elyria**
 (41.3684° N, 82.1077° W)
 Sears, Levi Lincoln (1825–1904) 110
- USA, Ohio, Lorain, Elyria, Ward 2**
 Sears, Levi Lincoln (1825–1904) 110
- USA, Ohio, Lorain, Grafton**
 (41.2726° N, 82.0546° W)
 Sears, Thomas (1804–1850) 137
- USA, Ohio, Medina, Chatham**
 (41.0995° N, 82.0245° W)
 Sears, Isaac W (1816–1895) 139
- USA, Ohio, Medina, Chatham Center, Chatham**
 Sears, Isaac W (1816–1895) 139
- USA, Ohio, Medina, Litchfield**
 (41.1678° N, 82.0231° W)
 Sears, John (1812–1887).....109
 Thacher, Martha (1815–1887) 109
- USA, Ohio, Medina, Wadsworth**
 (41.0256° N, 81.7299° W)
 Phelps, John Henry (1792–1874) 93

**USA, Ohio, Montgomery,
Dayton**
(39.7589° N, 84.1917° W)
Beebe, Capt Byron Crosby
(1830-1905).....251

USA, Ohio, Morrow
(40.5259° N, 82.798° W)
Marvin, Laura (1796-1871)..116
Sears, Enoch Smith (1795-1875)
.....116

**USA, Ohio, Morrow,
Bloomfield**
Marvin, Laura (1796-1871)..116
Sears, Enoch Smith (1795-1875)
.....116

USA, Pennsylvania
(40.8583° N, 76.3834° W)
Lamerson, John Harrison (1785-
1863).....218

**USA, Pennsylvania,
Bradford County, Troy**
(41.7859° N, 76.788° W)
Northrop, Harriet (1824-1911)
.....189
Sears, Jacob Brush (1823-1893)
.....189

**USA, Pennsylvania,
Bradford, Troy**
(41.7859° N, 76.788° W)
Sears, Jacob Brush (1823-1893)
.....189

**USA, Pennsylvania, Erie,
Wheelock**
Howard, Martha (1793-1854)
.....120
Raymond, Lewis Napoleon
(1788-1852).....120

**USA, Pennsylvania,
Lebanon, Cold Spring**
(41.5896° N, 76.7327° W)
Misner, Catherine (1820-1895)
.....170

**USA, Pennsylvania,
Potter, Genesee**
(41.9892° N, 77.8661° W)
Sherwood, Angeline (1844-
1914)..... 54, 270

**USA, Pennsylvania,
Warren, Columbus**
(41.9408° N, 79.582° W)
Howard, Martha (1793-1854)
.....120
Raymond, Lewis Napoleon
(1788-1852).....120
Raymond, Seth Sears (1798-
1873).....120
Raymond, Zacheus (1766-1844)
.....119

Sears, Sarah (1767-1860)... 119

**USA, Pennsylvania,
Warren, Columbus
Township**
(41.9408° N, 79.582° W)
Eagles, Caroline (-1851) 121
Raymond, Seth Sears (1798-
1873).....120

**USA, Pennsylvania,
Warren, Columbus,
Curtis Cemetery**
Eagles, Caroline (-1851) 121

USA, Pennsylvania, Wayne
(41.6502° N, 75.3064° W)
Sears, Miles (1798-1870).... 170

**USA, Pennsylvania,
Wayne, Damascus**
(41.7031° N, 75.0686° W)
Sears, Miles (1798-1870).... 170

**USA, Pennsylvania,
Wayne, Lebanon**
(40.3409° N, 76.4114° W)
Sears, Miles (1798-1870).... 170

**USA, Pennsylvania,
Wayne, Rileyville**
Sears, Miles (1798-1870).... 170

USA, Vermont
(43.8726° N, 71.55° W)
Knowlton, Miles Justine (1825-
1874)..... 242
Sears, Millicent (1786-1868).76,
165

**USA, Vermont, Addison,
Shoreham**
(43.8936° N, 73.3164° W)
Haswell, Zimri (1817-1858). 163

**USA, Vermont,
Bennington**
(43.0293° N, 73.1084° W)
Norton, Martin Story (1788-
1875)..... 161
Robinson, Betsy (1780-1843)
.....160, 161
Robinson, Henry (1809-1891)
.....161
Sears, Benjamin Robinson
(1807-1887)..... 162
Sears, Charles Follett (1817-
1841)..... 162
Sears, Delia Maria (1821-1853)
..... 163
Sears, Emily Hyde (1805-1877)
..... 161
Sears, Jared (1779-1828) ... 160
Sears, Mary Ann (1804-1899)
..... 161
Walbridge, Caroline Scott (1835-
1909)..... 252

Waters, Mary Ann (1805-1887)
..... 162

**USA, Vermont,
Bennington, Arlington**
(43.0748° N, 73.154° W)
Sears, Elizabeth "Betsy" (1783-
1843).....76, 163

**USA, Vermont,
Bennington,
Bennington**
(42.8781° N, 73.1968° W)
Walbridge, Caroline Scott (1835-
1909)..... 252
Waters, Mary Ann (1805-1887)
..... 162

**USA, Vermont,
Bennington,
Sunderland**
(43.1133° N, 73.1036° W)
Brownson, Isaac (1763-1832)
..... 150
Brownson, Sophronia (1788-)
..... 150

**USA, Vermont,
Bennington,
Sunderland, perh**
Brownson, Cornelia White (1804-
)..... 151
Brownson, Gideon (1790-) .. 151
Brownson, Isaac Jr (1809-) . 151
Brownson, James (1802-1803)
..... 151
Brownson, Richard (1795-) . 151
Brownson, Thirza (1792-) ... 151

**USA, Vermont,
Bennington, Winhall**
(43.1692° N, 72.9223° W)
Walbridge, Caroline Scott (1835-
1909)..... 252

**USA, Vermont, Franklin,
Berkshire**
(44.9717° N, 72.7758° W)
Sears, Giles (1810-1851).... 158

**USA, Vermont, Franklin,
Fletcher**
(44.6833° N, 72.9142° W)
Sears, Elizabeth "Betsy" (1783-
1843).....76, 164

**USA, Vermont, Franklin, St
Albans**
(44.8108° N, 73.0836° W)
Montague, Elizabeth (1807-
1813)..... 164
Sears, Lucy Robinson (1810-
1892)..... 162

**USA, Vermont, Franklin,
Swanton**
(44.9181° N, 73.1243° W)

Montague, Harry (1805-) 164
 Sears, Emily Hyde (1805-1877)
 161
 Sears, Mary Ann (1804-1899)
 161

**USA, Vermont, Franklin,
 Swanton, perh**

Montague, Electa S (1820-). 164
 Montague, Elizabeth (1807-
 1813) 164
 Montague, Harriet E (1815-) 164
 Montague, James Sears (1818-
 1860) 164
 Montague, Jane A (1811-)... 164
 Montague, Julia (1809-1859)
 164
 Montague, Lucy (1813-1839)
 164
 Montague, William H (1824-)
 164

**USA, Vermont, Grand Isle,
 Alburg**

(44.975° N, 73.3002° W)
 West, Erastus Robert (1804-
 1884) 158

**USA, Vermont, Lamoille,
 Cambridge**

(44.6448° N, 72.8762° W)
 Montague, Joseph (1779-) .. 164

**USA, Vermont, Orleans,
 Jay**

(44.9475° N, 72.4375° W)
 Sears, Electa (1813-1879) .. 158
 West, Erastus Robert (1804-
 1884) 158

**USA, Vermont, Windham
 County, Guilford**

(42.8178° N, 72.577° W)
 Shepardson, Laurilla (1818-
 1850) 172

USA, Washington

(47.2667° N, 119.125° W)
 Clark, (1817-) 95

**USA, Washington, Grant,
 Lakeview**

(47.374° N, 119.5023° W)
 Sears, Theodore Crosby (1828-
 1898) 192

**USA, Washington, Pierce,
 Tacoma**

(47.2529° N, 122.4443° W)
 Sears, Theodore Crosby (1828-
 1898)192

**USA, Wisconsin, Fond du
 Lac, Oakfield**

(43.6861° N, 88.5465° W)
 McKnight, Calvin Sears (1804-
 1872)101

USA, Wisconsin, Monroe

(43.9451° N, 90.6196° W)
 Goodrich, Jacob (1781-) 84

USA, Wisconsin, Walworth

(42.6681° N, 88.5416° W)
 Crosby, Nelson (ca.1817-1899)
167

**USA, Wisconsin,
 Walworth, Geneva**

(42.6205° N, 88.487° W)
 Brush, Charlotte A (1819-) .. 45,
 254

Index of Individuals { TC "Index of Individuals" \f C }

Abernathy	Joseph Lewis 251	Boughton
Ursula (1810-1869) 91	Rebecca..... 215	Catharine (1776-1816) .. 37 , 227, 230, 231, 232, 233
Allen	Belden	Matthew ...37, 227, 230, 231, 232
Daniel Birchard 231	Daniel 111	Bowers
Sarah 219	Miriam..... 112	Sally P (1800-1833) 170
Allison	Miriam (1744-) 111	William Mansfield (1802-1864) 172
Mary Ann (1833-)..... 234	Bell	Zephaniah 170
Anderson	Ann (1799-1853) 203, 204	Bradley
Charles 275	Benedict	Elizabeth M (1821-)..... 108
Prudence Emeline (1866-1931) 284	Camilla (1821-1832)..... 176	Brandt
Andrews	Caroline Aurelia 177	Rosa M (1872-1948)..... 277
Abigail (1776-) 15 , 49, 51, 52, 55, 57, 259, 260, 261, 264, 265, 268, 269, 271, 272, 281, 284, 286, 288, 289, 290	Czar (1769-1858)..... 176	Bristol
Ruhamah (1782-1813)..... 123	Edward Beebe (1829-)..... 215	James (1802-)..... 104
Andrus	Edwin Sears (1824-)..... 176, 177	Mary Ann (1808-)..... 129
Sturges..... 171	Elijah (1765-1822) . 30 , 212, 213, 215	Brooks
Arnold	Elijah (1827-) 213, 214	Charles I (1872-) 291
Benjamin Mitchell..... 212	Enomel (ca.1855-) 257, 258	Chauncy (1798-1885)..... 86
Diantha (-1860) 121	Esther (1762-) ...41, 42, 242, 244	Jabez86
Baldwin	Ezra Pearce (1792-1852)30, 212 , 213, 215	James 291
Deborah (1749-1828) 71, 72 , 130, 131, 133, 135, 136, 139, 140, 143, 144, 146, 147, 148	George Peter (1835-).... 215, 216	--Brooks
Thomas (1724-1794) 71, 72, 130, 133, 135, 136, 139, 140, 143, 144, 147, 148	Henry Pearce (1831-) 215	Rhoda86
Bangs	Joanna (1820-1860)..... 213, 214	Brown
Apphia (1651-1707) 59	John..... 257	Elsworth William (ca.1871-) . 278
Barager	John Barnum (ca.1820-) 257	Marilla290, 291
Charles Fredrick Sr (1838-1891) 207, 208	Levi Starr..... 239	Sarah (1815-)..... 94
Emeline (1826-)..... 207, 208	Philander (1816-1884)..... 213	Browne
George T (1832-) 207, 208	Samuel (1743-) 176	Anna (-1856)..... 36
Herbert A (1830-)..... 207, 208	Samuel Joseph (1833-)..... 215	Brownson
James (1836-) 207, 208	Stephen..... 177	Cornelia White (1804-) . 150, 151
Judge Samuel (1794-1871) . 207 , 208	Tamar (1813-)..... 213	Gideon (1790-)..... 150, 151
Mahala Ann (1824-)..... 207, 208	Ursula (1818-1832)..... 176	Isaac (1763-1832) 150
Samantha (1828-)..... 207, 208	Bennett	Isaac Jr (1809-)..... 150, 151
William (1838-)..... 207, 208	Catherine.....25, 26, 211	James (1802-1803)..... 150, 151
Barnes	Priscilla (1774-1851) 149	Richard (1795-) 150, 151
Myron S 256	Robert..... 138	Sophonra (1788-)..... 150
Barnum	Sarah 44, 45, 252, 253, 255, 256, 257, 258	Thirza (1792-) 150, 151
Justina..... 215	Betts	Brush
Lucinda.....257	Elizabeth (1796-1880) . 197, 198	Ann Elizabeth (1827-)44, 46, 257
Patty M (1793-1815)..... 186	Josiah.....197, 198	Benjamin S (1845-)..... 253, 254
Theron E (1853-1920)..... 238	Rial (1804-1887)..... 138	Caroline..... 44, 46
Bartlett	Bivens	Caroline (1843-) 253, 254
(unknown given name)238	Roxanna (1803-1831)..... 137	Charity (1857-)..... 253, 254
Georgianna (1853-) 238	Blackman	Charity Elizabeth (1810-) . 44, 45, 252
Robert238	Adoniram S (1837-1879)..... 244	Charlotte A (1819-) . 44, 45, 254 , 255, 256
Beebe	Blake	Charlotte Ardelle (1866-) 258
Capt Byron Crosby (1830-1905)251	Carl F221	Cornelia (1843-) 253, 254
Ezra B 213	Charles F (1823-1897)..... 221	Elizabeth (1858-) 258
	Blinn	James (1834-)..... 44, 46
	Clarissa (1790-1868) 88	James S (1851-)..... 253, 254
	Boardman	Joseph Bennett (1786-1858) . 44 , 45 , 252, 253, 254, 255, 256, 257, 258
	Allyn (1773-1837) 132	Knowles Sears (1811-1882) ...44, 45, 253
	Maria (1800-1888) 132	Mary (1748-)..... 128
	Bolger	Mary (1821-)..... 44, 45, 256
	Mary A (1858-1908) 248	

- Mary A (1796–1872).....**188**
 Mary E (1838–)..... 253
 Sarah E (1835–)..... 253
 William C (1832–1875) 44, 46,
258
 Zophar P (1817–1900)..... 44, **45**
 Zopher.....44, 45, 252, 253, 255, 256,
 257, 258
- Buck**
 Eliza (1828–) 238
- Buckman**
 Sophia (1809–) 236
- Buell**
 Betsy 224, 225
- Bull**
 Hanna (1769–1850).....**130, 131**
- Bunker**
 Shepard Parker**166**
- Burgess**
 Abigail (1710–) ...28, 69, 70, 114,
 116, 119, 122, 123, 124, 128,
 168
 Samuel (1671–1753) 69
- Bursell**
 Anna (1642–1725/26)..... 59
- Bushnell**
 Asa (1827–)..... 210, **211**
 Asa West (1801–).....**210, 211**
 John (1829–) 210, **211**
- Butler**
 Almira (1790–1857).....**108**
 Charles E (1834–)**244**
 Levi (1796–)**97**
- Canfield**
 John (1830–)**243**
 Rufus 243
- Cargill**
 George (1802–1872)**103**
 John (1776–) 103
- Carr**
 Huldah (1763–).....**87, 88**
- Carrier**
 Ira (1805–).....**99**
- Cartwright**
 Daniel 227, 228
 Matilda (1801–).....**227**
- Carver**
 David Taylor 137
 Rachel Maria (1818–1905).....**137**
- Castle**
 Bradley (1786–1848).....**165**
 Evelyn (1828–) 165, **166**
 Horace 165, **166**
 Julia Ann (–1845)..... 165, **166**
 Lavinia (1812–1838)..... 165, **166**
 Maria 165, **166**
 Nathan Olmsted (1810–1876)165,
166
 Nelson..... 165, **166**
- Thirza 165, **166**
- Chamberlain**
 Sally (–1880).....**90**
- Christy**
 Charles Wesley (1864–1948) 281,
284
 Eliza J (1854–<1860) ... 281, **282**
 Elizabeth Ann (1858–1941) .. 281,
283
 James (1830–)..... **281, 282**
 Jennie Lynd (1861–1919)..... 281,
283
 Sara Ella (1856–1905).. 281, **282**
- Clark**
 (1817–)**95**
 Chloe (1807–1847).....**98**
 Robert Franklin**232**
 William.....**274**
- Coe**
 Horace**202**
- Col**
 David M Keeler (ca.1811–ca.1849)
**255**
- Cole**
 Amanda (1799–1871)**96**
 Levi (1797–).....**118**
- Coleman**
 Caroline H "Carrie" (1847–) ...**226**
 Lauren (1821–) 226
- Cook**
 Henry 224, 225
 Phebe (1819–1852).....**224, 225**
- Corwin**
 Elizabeth 271
 James**271**
 Sarah..... 271
- Cosgrove**
 Ann M (1819–)..... 226
- Craft**
 (1785–) **147, 148**
- Crane**
 Edgar Galloway (1837–1922). 276
 Edith M (1874–1927)**276**
 Eunice (1754–1839) **78, 79, 168,**
174, 176, 177, 178, 179, 180,
185, 186, 188, 191, 192, 195,
213
 Hannah (1767–1822)..... 124
 Sarah E (1818–) **178**
- Crane**
 Celinda Melissa (1846–1908). 276
- Crawford**
 Mary (1801–).....**129**
- Crocker**
 Thankful..... 127
- Crosby**
 Abigal (1752–)..... 66, **67**
 Charles 66, **67**
 Charles H (1831–).....**191**
- David.....111, **112**
 David (1719–) 77, 167
 Deborah (1790–1849) **180**
 Derias..... 66, **67**
 Desire..... 66, **67**
 Eber (1792–1836)..... 77, **167**
 Eli (1745–1827).....**77, 167**
 Elijah (1792–).....**178**
 Elizabeth111, **112**
 father 178, 179, 180, 191, 192
 James (1763–1833) .. 66, 67, **111**
 Joshua 66, 67, 111, 112
 Lemuel 66, **67**
 Mary..... 43, **251**
 Nelson (ca.1817–1899).....167
 Obadiah (1760–1830)..... **113**
 Reuben (1735–1819) **66, 67, 111,**
112
 Reuben (1755–)..... 66, **67**
 Ruth Ann..... 43, **250**
 Sarah (1667–1705/06) **18, 20, 59,**
63, 66, 68, 69, 71, 73, 74, 77,
78
 Sarah (1800–1869) **191, 192**
 Stephen B (1784–).. **43, 250, 251**
 Tertullus (1775–1874)66, 67, **112**
 Thankful (1784–1830)113
 Theodore43, 250, 251
 Thomas (–1702) 59
- Crosby**
 Sarah (1645–) 59
- Crow**
 Mary (1780–)103
- Crowell**
 Mehitable (1691–1766).....116
- Curtis**
 Jonathan **115**
- Davis**
 Charlotte (1824–) **159**
- Day**
 Lindsey **166**
 Mary O (1843–)**236**
- Dean**
 Angeline (1829–1881) **235**
 Stafford (1803–)235
- Degreater**
 Peter **258**
- Deming**
 Dorothy 84, 85
- Devenport**
 Elizabeth 227, 228
- Dewey**
 Jerusha 98
- Dewhurst**
 Susannah (1831–)..... **260**
- Douglass**
 Harvey (1808–)225
- Drum**
 (1806–) **252**

DuBois

Clarissa (1807-1873) **57, 284, 285, 286, 287, 288, 289, 290**

Durst

Mary Ann **259**

Durston

Maria **291**

Dutcher

Harriet E "Hattie" (1857-1882) **285**
 Hattie (Harriet E.". Dutcher) (1857-1882).....**286**

Eagles

Caroline (-1851)..... **121**
 Francis (-1817) **121**

Ellis

Jarvis C..... **166**

Estabrook

Charles Gouder (1850-1880) **238**
 Thaddeus (1824-).....**238**

Fairchild

John **154**

Farley

Francis B "Frank" (1856-1946) **288**

Ferguson

Effie **270**

Fobes

Zebina Eaton (1804-1886).... **162**

Folger

Elwood..... **269**

Foster

Anna (1779-1863) **95, 96**
 James (1738-1819) **68, 113**
 James (1771-1855) **68, 69**
 Jedediah **95, 96**
 Mary (1709/10-1747) **111**
 Mary (1764-1830) **68, 69, 113**
 Mercy **43, 250, 251**
 Timothy **73, 74**

French

Matilda (1823-1890) **110**

Gardner

Minerva (1812-) **137**

Gidley

Mary (1825-1900) **127**

Gilbert

Mercy **218**

Goodrich

George (1783-) **83, 84**
 Jacob (1755-1833) **83**
 Jacob (1781-) **83**
 Millicent **74, 76, 150, 151, 152, 154, 155, 160, 163, 165**

Gordon

Polly (1796-1855) **129**

Green

Sarah O. (1839-)..... **223**

Gregory

(1799-)..... **39, 40, 239**
 Adeline (1801-1836). **39, 40, 240**
 Caleb Curtis (1771-1845) **39, 40, 239, 240**
 Charles (?-) **39, 40**
 Delos (1797-) **39, 40**
 John.....**39, 40, 239, 240**
 Sarah E (1823-1893)... **244, 245**

Griffiths

Avilda S (1800-1890) ... **174, 175**
 Jeremiah (1776-1814) **174**

Gunn

Gideon **84, 85**
 Lavina (1771-1847)..... **84, 85**

Hadden

Morris..... **137**
 Susan (1815-1845) **137**

Hall

Hannah (1680-1753) **69**
 Mary (1741-1814) **28, 144**
 Sally (1784-) **106**

Hamblen

Lois (1778-) **85**

Hand

Rebecca..... **89**

Harkness

Maria (1835-) **216**
 Oliver **216**

--Harkness

Laura **216**

Hart

Louisa Celestia (1836-1898) . **229**

Haswell

Zimri (1817-1858)..... **163**

Haviland

Benjamin Vail **142**
 Charity (1750-1836).. **18, 43, 44, 46, 250, 251, 252, 253, 255, 256, 257, 258**
 Richard Towner (1829-1908) **142**

Hawley

Aaron (1790-)..... **25, 27**
 Amos (1795-) **154**
 Anna (1800-)..... **154, 155**
 Arza (1792-1823)..... **25, 27**
 Betsey (1801-) **154, 155**
 Comfort Sears (1788-1874)....**25, 27**
 Elizabeth (1786-) **25, 27**
 Ephraim (1798-) **154**
 Ephraim Jr (1767-1852)..... **154**
 George (1800-)..... **25, 27, 211**
 Harriet (1815-) **154, 155**
 Harvey (1794-) **25, 27**
 Henry (1798-)..... **25, 27**
 Henry (1812-)..... **154, 155**
 Hulda (1793-)..... **154**
 James (1803-1872) **25, 27**

Maria (1807-)..... **25, 27**
 Matilda (1805-1877)..... **25, 27**
 Millicent (1804-) **154, 155**
 Nathan (1763-1810). **25, 26, 211**
 Nathan Sears (1807-)... **154, 155**
 Samuel..... **25, 26, 211**
 Samuel (1796-1852) **25, 27**
 Susan (1820-) **211, 212**
 Susanna (1810-)..... **25, 27**
 Thirza (1809-) **154, 155**
 William (1791-)..... **154**

Hayden

Zora..... **218**

Hayt

Hawley **196**

Hedges

Jonathan **115**

Hendricks

Sally (-1883) **38**

Henning

Ida **289**

Hess

Mary **264**

Hibbard

Frances Marion (1830-1887) **261, 262**

Higgs

Martha P. (1886-) **270**

Hill

Naomi (1764-1839)..... **219, 220**

Hoffman

William (1782-)..... **88**

Holcomb

Laura L (1817-1903) **104**

Hollister

Rachel..... **95, 96**

Hopkins

Elizabeth (1668-1727) **69**
 Lydia..... **66, 67, 111, 112**
 Reliance (1723-) **77, 167**

Hotchkiss

Maria **202**

Howard

Martha (1793-1854) **120**

Howe

Augusta R (1833-1880) **234**
 Persis **200**

Howes

David (1759-)..... **115**
 Elizabeth (1694-) . **63, 65, 83, 84, 87, 90, 91, 92, 94, 95, 100, 102, 105, 106, 108**
 Joseph (1659-1743) **63**
 Mary (1785-1874)..... **115**

Howland

Emily Jerusha "Jerush" (1812-1898)..... **98**
 Joseph..... **98**

- Joseph (1774–1798).....85
 Polly (1800–1869).....**85**
- Hoyt**
 Elizabeth H (1829–1886).....**193**
 Hezekiah**88**
 S M (1797–)**171**
 Starr (1803–)..... 193
 Walter (1810–1888)**173**
- Hubby**
 Mary (1768–1807).....**92**
- Husted**
 Laura A 269, 270
- Hyde**
 Austin 269, 270
 Gerald Leland (1882–1957) .. 269,
270
 Grant Austin (1876–1951).... 269,
270
 John Arthur (1868–1940) 269,
270
 Ray Sears (1886–1977) 269, **270**
 William Henry (1841–1927)..**269**,
270
- Jarvis**
 James 242, 243
 Marietta (1814–1905)**242**
- Johnson**
 Eunice 237
- Jones**
 Almira A (1820–1910)..... 49, **50**
 Angeline Sears (1827–1898)... 49,
50
 Catherine L (1834–1901)... 49, **50**
 Ebenezer 49, **51**
 Ebenezer (1799–1886).....**49**
 Elizabeth Mahaley (–1839)**112**
 Emeline (1836–1839) 49, **50**
 Isaac 49, **51**
 Juliet..... 49, **51**
 Mary (1766–1813)..... 195
 Mary L (1846–1846) 49, **50**
 Matilda (1822–1914) 49, **50**
 Rufus (1823–1874)..... 49, **50**
 Visonia**89**
 Wesley (1832–1840)..... 49, **50**
- Judd**
 Lucy (1776–1841)**102, 103**
 Lyman..... 98
 Lyman C.....**99**
 Mariette (1811–1881)**98**
 Uriah 102, 103
- Judd**
 Amanda 98
- Kent**
 Richard**287**
- Kingsley**
 Algernon S (1839–) 219, **223**
 Asahel (1762–1849) 219, **220**
 Cyrus (1830–)..... 219, **222**
 Cyrus Hills (1789–1878) **219, 220**
 Edward (1828–1858) 219, **222**
 Emily (1823–)..... 219, **222**
 Knowles (1825–1827) ... 219, **222**
- Oliver (1816–) 219, **221**
 Polly (1819–1876)..... 219, **221**
 Ulysses (1834–1836).... 219, **223**
- Knapp**
 Robert**173**
- Kneeland**
 Gardner**166**
- Knowles**
 John (1640–1675)..... 59
 Rebecca (1674/75–1758) ..18, 20,
 59, 60, 63, 66, 68, 69, 71, 73,
 74, 77, 78
- Knowlton**
 Miles Justine (1825–1874).....**241**
- La Du**
 Brinkerhoff (1808–1883).....**218**
 Tompkins 218
- Lamerson**
 Betsy (1819–)..... 217, **218**
 George (1833–1849) 217, **219**
 Jacob 217, 218
 Jacob (1817–1860)..... 217, **218**
 John Harrison (1785–1863) ...**217**
 John Sears (1823–1862) 217, **218**
 Mary (1826–)..... 217, **218**
 Matilda (1831–) 217, **219**
 Sears (1828–1866) 217, **218**
 Susan (1814–1904)..... 217, **218**
 Tamma (1821–)..... 217, **218**
 Wayne (1836–)..... 217, **219**
- Lawrence**
 Hannah**166**
 Phebe**166**
- Lester**
 Susan (1812–)..... 225
- Lewis**
 Charles 286, **287**
 Clara 286
 Emory**286, 287**
 George..... 286, **287**
 Hetty 286, **287**
 Ichabod (1752–) 133
 Ida 286, **287**
 Isaac 286
 John 286
 Sally Betsy (–1858) **133**
- Lincoln**
 Almira (1823–1896) **146**
- Lord**
 Alson**171**
- Low**
 Mary "Polly" (–1871)..... 121
- Ludington**
 (1785–) **147**
- Lusk**
 Phebe (1784–1855) ...**34, 35, 224**
- Lyman**
 Charles Pyncheon (1831–1868)
**236**
 Henry D (1805–)..... 236
- Mandaville**
 Ina L (ca.1880–1947) **280**
- Manderville**
 Marcus A (1841–1916)280
- Manderville**
 Loiza (1846–1914).....280
- Markell**
 Mary Jane (1846–1924) **208**
- Marvin**
 Betsy (1778–1854) **124, 125**
 Laura (1796–1871) **116**
- McClellan**
 Alexander "Alex" (–1947)..... **275**
- McCracken**
 Minerva (1804–1830) **129**
- McGough**
 Catherine (1859–1908)..... **249**
- McKnight**
 Calvin Sears (1804–1872).....100,
101
 Robert **100, 101, 105**
- McQueen**
 Adeline E..... **254**
- Meeker**
 Elizabeth (1814–1881)..... **253**
- Melancthon**
 Emily **216**
- Merrell**
 Jerad**110**
 Lydia C (1809–)..... **110**
- Mideman**
 Mary.....**221**
- Millard**
 Mary Ann (1807–1876)..... **107**
 Samuel**107**
- Millard**
 Chloe.....**107**
- Miller**
 Lucy 102, 103
- Misner**
 Catherine (1820–1895)..... **170**
- Mitchell**
 Elizabeth (1777–1842).....**153**
 Susan Ann (1801–1890) **126**
- Montague**
 Electa S (1820–).....163, **164**
 Elizabeth (1807–1813)...163, **164**
 Harriet E (1815–).....163, **164**
 Harry (1805–)163, **164**
 James Sears (1818–1860).....163,
164
 Jane A (1811–).....163, **164**
 Joseph (1779–)..... **163, 164**
 Julia (1809–1859).....163, **164**
 Lucy (1813–1839).....163, **164**
 Samuel 163, **164**
 William H (1824–).....163, **164**

Moore	Deborah (1727-1759) 71, 72, 130, 133, 135, 136, 139, 140, 143, 144, 147, 148	Race	Henry 173
Ann Eliza (1809-1891) ... 55, 271, 272, 273, 281, 282	Deborah (1767-1837) 111	Raymond	Enoch (1792-) 119, 120
Daniel.....236	Eunice (1792-)..... 122	Esther 167	Harriet Almira (1819-) 187
Sophronia (1838-1902)..... 235	Mary (1734-1826) 63, 65, 83, 84, 87, 89, 90, 91, 92, 94, 95, 96, 100, 102, 105, 106, 108	Harvey (1790-)..... 119, 120	John (1795-1875) 187
Morgan	Paine	Lewis Napoleon (1788-1852) 119, 120	Lorenzo (1802-)..... 119, 121
Lydia Ann..... 130	Mary (1730-)116, 117	Matilda (1800-)..... 119, 121	Seth Sears (1798-1873) 119, 120
Morris	Palmer	Zacheus (1766-1844) 119	Reed
Sally (1798-) 46	Ophelia.....291	Reed	Helen C (ca.1837-)..... 229
Munsell	Parish	Rewey	Angeline (1829-)..... 231, 232
Lucretia (1808-) 139, 140	Isaac (1812-)194	Martha Ann (1826-)..... 231	Mary Augusta (1836-)... 231, 232
Nelson	Roxcellana (1838-1867)..... 194	Oliver (1804-1883) 231	Richards
Sarah "Sally"137	Parker	Richards	Mary (-1853)..... 130
Newell	John..... 110	Richmond	Rose (1834-)..... 193
Freelove..... 232, 233	Partridge	Rider	Anna (1794-1866)..... 116, 117
Nichols	Edward Turner (1799-1887) . 171	Charles Paine (1796-1875)... 116, 117	James W (1807-1871) .. 116, 118
Browning200	Peck	John (1714-)116, 117	Rebecca (1801-1844) ... 116, 118
Hannah (1825-1878) 200	Isaac..... 218	Robert Delos (1799-1867).... 116, 118	Zadoc(k) (1752-1827) ..116, 117
Lillian 286	William 219	--Rider	Susan (1821-) 118
Sally Maria (1807-).....193	Penny	--Rider	Susannah (1813-) 118
Noble	Rebecca (1800-) 117	Roberts	(unknown given name)..... 232
Oliver (1780-1839)..... 113	Perry	Robinson	Betsy (1780-1843)..... 160
Northrop	James A (1821-) 190	Henry (1809-1891) 161	Martha A. (1823-1901) 139
Francis B (1809-) 184	Mary M (1832-1883).... 195, 196	Samuel (1754-) 160	Rockwell
Harriet (1824-1911) 189	Nehemiah (1802-1873)..... 195	Rockwell	Marinda B (1813-1831)..... 181
James.....182	Simeon (1760-1853) 195	Rogers	Almira (1834-)..... 118
James (1783-)184	Stephen..... 112	Lucius D (1806-)..... 104	Russell
Mary Jane (1813-)..... 181	Phelps	Ryder	Huldah (ca.1816-)..... 101
Polly243	Doratha109	John (1692-1766) 116	Sabin
--Northrop	John Henry (1792-1874) 93	Sabin	Mary "Polly" (1803-1879)..... 97
Susan182	Picket	Origen.....97	
Norton	Betsy (1797-1858) 187		
Martin Story (1762-).....161	Pierson		
Martin Story (1788-1875)..... 161	(unknown given name)..... 115		
Nutt	Pine		
David (1779-1845)153	Sally (1792-1859) 132		
Fanny (1805-1861)..... 153	Platt		
Margaret (1804-1883) 153	Lucy242, 243		
Nye	Lyman (1819-1866)..... 189		
James.....127	Porter		
Mary (1809-1854) 126	(1803-)..... 164		
Ocobock	Electa.....236		
Albert (1815-1882)..... 202	Jonathan Edwards..... 164		
Olmstead	Potter		
Elizabeth (1746-) 74, 76, 150, 151, 152, 154, 155, 160, 163, 164, 165	Laura H 164		
Nathan 74, 76, 150, 151, 152, 154, 155, 160, 163, 165	Powers		
O'Neil	Harriet (-1822) 137		
James..... 173	Price		
Osborn	Anna Crosby..... 250		
Hannah..... 97	Roderick 250		
Overacre	Putnam		
(1812-) 138	Roxanna 268		
Paddock	Quintard		
David (1705-1772)111	Ann Eliza "Eliza" (1818-) 178		
David (1734-)111			

Safford

Esther (1758-)..... 160
Lucy..... 163, 164

Sager

Hannah Theresa**155, 157**

Sanford

Betsy Ann (1816-1889)**184**
Seth 184

--Sanford

Esther 184

Savage

Rosetta**166**

Sawyer

Fred.....**264**

Schofield

Charlotte M (1836-)**111**
Sarah W (1827-1856).....**110**

Scofield

Amos (1796-1844).....**175**

Sears

Abigail (1788-1859) 87, **88**
Abigail (1829-) 55, **271**
Abijah (1774-1839).....20, 21, **35, 36, 37, 38, 227, 230, 231, 232, 233**
Abijah (1798-1837)..... 23, **24**
Adelaid (1836-1858) 203, **206**
Adelaide (1805-1876)..... 33, **34**
Ahiram (1795-1856)..23, 24, **203**
Albert Edgar (1832-1903) 232, **234**
Alexander (1782-1828). 114, **115**
Alfred (1789-1856) 23, **24**
Alonzo (1827-1904) 201, **202**
Alonzo Elmore (1825-1862).. 188, **190**
Ambrose (1793-1843)23, 24, **201**
Angeline (1799-1864)..... 15, **49**
Ann Eliza (1857-1892).. 272, **274**
Ann M (1800-1874)..... 124, **126**
Ann Maria (1813-1847) 95, **99**
Ann Maria (1816-)..... 94, **95**
Archibald (1780-1864)..... 71, 72, **140**
Archibald (1802-1893).. 136, **137**
Arza (1790-1859)23, 24, **197**
Atha (1790-1827) 78, 80, **213**
Benjamin (1706-1787)28, 168
Benjamin (1738-1827)28, 144
Benjamin F (1856-1926)244, **248**
Benjamin Robinson (1807-1887) 160, **162**
Bethia (1756-1826).....63, 65, **83**
Betsy (1784-1854)..... 114, **115**
Betsy (1802-1819)..... 33, **34**
Betsy (1848-1917)..... 244, **247**
Betty (1763-1846)20, 21, **25, 211, 212**
Burt (1869-1952)..... 272, **276**
Calvin (1769-1859)63, 65, **92, 94**
Camilla (1786-1815) .78, 80, **178**
Camilla (1807-1827) 168, **171**
Camilla Maria (1816-1886)... 180, **184**

Caroline "Carrie" (1872-1951) 272, **277**
Caroline (1816-1857)... 136, **138**
Caroline Miranda (1848-1934) 232, **238**
Caroline Ophelia (1824-1911) 168, **173**
Catherine M (1832-)..... 209, **210**
Charity (1789-1859) ..18, 19, **43, 250, 251**
Charles (1780-1836)..20, 21, **41, 242, 244, 245**
Charles (1800-1870)..... 37, **230**
Charles Andrew (1803-1855) .90, **91**
Charles E (1845-1919) . 244, **246**
Charles Follett (1817-1841) . 160, **162**
Charles Williams (1830-1915) 232, **234**
Chauncey (1799-1841)..... 84, **85**
Clara M (1804-1821)..... 41, **42**
Clara Maria (1836-1914)242, **243**
Clara Marilla "Marilla" (1868-1938) 290, **291**
Clarissa 155, **159**
Clarissa (1801-1824) ... 168, **170**
Clarke Crosby (1827-1915).. 180, **184**
Comfort (1751-1827) .59, 61, **78, 168, 174, 176, 177, 178, 179, 180, 185, 186, 188, 191, 192, 195, 213**
Corydon Birch (1839-1905).. 232, **236**
Daniel (1762-1840).. 20, **23, 197, 201, 203, 207, 209, 210, 211**
Daniel Deliance (1831-1864) 203, **205**
David (1731-1827)59, 60, **63, 83, 84, 87, 89, 90, 91, 92, 94, 95, 96, 100, 102, 105, 106, 108**
David (1761-1842) 63, 65, **87**
David (1785-1855) 87, **88**
David (1808-) 106, **108**
David (1825-) 227, **228**
David F (1791-1872).... 130, **132**
David H (1794-1830) ..18, 19, **46**
Deborah (1789-).....71, 73, **146, 147, 148**
Deborah (1807-1840)... 136, **138**
Delia Maria (1821-1853)160, **163**
Delphine Augusta (1842-1915) 232, **236**
Desire (1747-).....59, 61, **73**
Desire (1778-1879) ...20, 21, **39, 239, 240**
Desire (1782-1854) ..78, 80, **176**
Dioclesian (1808-1905) 102, **104**
Ebenezzer A (1798-1868)..... 123
Edward (1805-1875) 87, **89**
Edwin Collins (1808-1866)41, 42, **242**
Egbert (1832-) 227, **229**
Eleazar (1801-1841) 87, **89**
Eleazar H (1771-1855)69, 70, **124**
Electa (1813-1879)..... 155, **158**
Eli (1768-1800)71, 72, **130**
Eli (1800-1854) 136

Elijah (1771-)..... 63, **65**
Elijah (1794-)..... 90
Elijah (1814-1878).....108, **109**
Eliza Ann (1823-1879) ..180, **184**
Elizabeth "Betsy" (1783-1843)74, 76, **163**
Elizabeth (1775-)..... 63, 66, **100**
Elizabeth (1775-1790)..... 71, **72**
Elizabeth (1790-1880)18, 19, **44, 252, 253, 254, 255, 256, 257, 258**
Emily Hyde (1805-1877)160, **161**
Emma (1850-)244, **247**
Enoch Hamlin (1761-1869)70, **114**
Enoch Smith (1795-1875).....114, **116**
Erastus (1809-)..... 37, **38**
Erastus (1821-1889).....227, **228**
Esther (1780-1811) ..78, 80, **174**
Esther (1813-1883)168, **172**
Esther Camilla (1829-)..188, **190**
Eunice (1784-1858) ..78, 80, **177**
Eunice (1803-)168, **171**
Evaline "Eva" (1873-1949)....272, **278**
Fannie (1802-1872)..... 92, **93**
Fannie Baldwin (1832-1902) .140, **142**
Francis (1808-1870)124, **126**
Francis Augustus "Frank" (1833-)191, **193**
Frank (1878-1971)272, **280**
Frederic Jerome (1851-1863)232, **238**
George (1812-1882)144, **145**
George (1823-1866) .41, 42, **244**
George (1854-)244, **247**
George Belden (1809-1877)...180
George E (1815-1884) ..168, **172**
George S (1804-1858) ..124, **126**
George W (1840-)209, **210**
George Washington (1811-).... 94
Giles (1810-1851)155, **157**
Gould Boughton (1811-1900)180, **183**
Haman (1807-1838) ..15, 16, **55, 271, 272, 273, 281**
Haman Hannibal (1839-1879) 57, **58, 290**
Hannah (1797-1898) 33, 34, **219**
Hannah (1821-)..... 94, **95**
Hannah (1825-).....230
Harriet (1819-1888)..... 95, **99**
Harriet Alice (1873-1915)290, **291**
Harry (1825-1845)203, **204**
Hart Boughton (1807-1885)... 37, **38, 232**
Heman (1767-1817) **28, 144, 145**
Heman (1807-1880) ..15, 16, **57, 284, 285, 286, 287, 288, 289, 290**
Heman (1818-1893)144, **145**
Heman (1861-1885)272, **275**
Henrietta Louisa (1835-)188, **190**
Henry (1823-).....230
Henry Williams (1833-1879) .232, **235**
Herman Barnum (1815-1885) 186

- Hester Marie (1836-1918) 57, 58, **287, 288, 289**
- Hezekiah (1770-1819) 74, 76, **152**
- Hezekiah Jr (1800-1873) 152, **153**
- Hiram (1811-1904)..... 168, **171**
- Huldah (1767-1843) . 74, 76, **150**
- Huldah (1798-)87, **88**
- Isaac (1763-) . 63, 65, **89, 90, 91**
- Isaac (1772-1839).....149
- Isaac (1776-1848)**13, 14, 15, 20, 21, 49, 51, 52, 55, 57, 259, 260, 261, 264, 265, 268, 269, 271, 272, 281, 284, 286, 288, 289, 290**
- Isaac (1786-1868).... 71, 73, **144**
- Isaac (1802-1872).....38, **39**
- Isaac (1803-1834).....87, **89**
- Isaac (1821-1823)..... 144, **146**
- Isaac (1833-1914).....55, **272**
- Isaac W (1816-1895).....136, **139**
- Jacob Brush (1823-1893) 188, **189**
- James..... 91
- James (1704-1791)14, 15, 17, 18, 20, 23, 25, 28, 30, 31, 33, 34, 36, 37, 38, 39, 41, 43, 44, 46, **59, 63, 64, 66, 67, 68, 69, 71, 73, 74, 77, 78, 79, 83, 84, 87, 90, 91, 92, 94, 95, 100, 102, 105, 106, 108, 111, 112, 113, 114, 116, 119, 122, 123, 124, 128, 130, 133, 135, 136, 139, 140, 143, 144, 147, 148, 150, 151, 152, 154, 155, 160, 163, 165, 167, 168, 174, 176, 177, 178, 179, 180, 186, 188, 191, 195, 213**
- James (1747-) ... 59, 61, **74, 150, 151, 152, 154, 155, 160, 163, 164, 165**
- James (1776-1847) .. 63, 66, **102**
- James (1778-1857) . 71, 72, **133, 135, 136, 139**
- James (1788-1878) . 78, 80, **179, 180**
- James (1797-1835)37, **227**
- James (1802-1803) 102, **103**
- James (1818-1897) 108, **110**
- James (1822-1923) 197, **199**
- James (1839-) 135
- James Jr (1773-1843).....74, **76**
- James Jr (1821-)..... 155, **159**
- James William (1809-) .. 168, **171**
- Jane A (1847-).....209, **210**
- Jane Ann (1821-1848) .. 203, **204**
- Jane Eliza (1838-) 242, **243**
- Jared (1779-1828) ... 74, 76, **160**
- Jennie H (1864-1920) ... 272, **275**
- John (1772-1839) 20, 21, **32, 33, 34, 35, 217, 219, 224**
- John (1807-1877).....87, **89**
- John (1812-1887)..... 108, **109**
- John (1821-1857)..... 34, 35, **224**
- John Calvin (1804-1874) ... 92, **93**
- John Chester (1836-)..... 209, **210**
- John J (1831-) 227, **228**
- John Sylvester (1867-1958)..272, **276**
- John William (1834-1843) .57, **58**
- Joseph (1675-1750) 69
- Joseph Crane (1792-1857)78, 80, **185, 186, 188**
- Kate (1798-).....15
- Kate (1834-1892) 140, **142**
- Knowles (1738-1817) .13, 14, 15, **17, 18, 20, 23, 25, 28, 29, 30, 31, 32, 33, 34, 35, 36, 37, 38, 39, 41, 43, 44, 46, 49, 51, 55, 57, 59, 61, 144, 197, 201, 203, 207, 209, 210, 211, 213, 215, 217, 219, 224, 227, 230, 231, 232, 239, 240, 242, 244, 250, 251, 252, 253, 255, 256, 257, 258**
- Knowles (1768-1848) 20, **21**
- Knowles (1800-1820) 33, **34**
- Laura Dickinson (1801-1871)..84, **86**
- Levi Lincoln (1825-1904)..... 108, **110**
- Lewis (1790-1860) 114, **115**
- Lewis (1795-1868) ... 78, 80, **191**
- Lewis (1807-1877) 123, **124**
- Lewis (1834-) 209, **210**
- Louisa (1824-1894)..... 201
- Lovilly (1786-1856) 87, **88**
- Lucy (1800-1870) 38, **39**
- Lucy (1802-1872) 102, **103**
- Lucy Robinson (1810-1892).. 160, **162**
- Luther (1774-1857).... 63, 65, **95**
- Luther (1806-1877).....95, **98**
- Lyman (1773-1842).. 74, 76, **155**
- Lyman (1799-1857)..... 152, **153**
- Major (1809-1828)..... 87, **89**
- Marcus (1833-1859)..... 203, **205**
- Margaret Eliza (1831-1915).. 188, **190**
- Maria (1805-1841) .. 23, 25, **210, 211**
- Maria (1826-) 201, **202**
- Maria (1829-1899) 108, **111**
- Marietta "Etta" (1859-1932) .272, **274**
- Marietta (1809-1896) 95, **99**
- Marshall (1802-1883) 95, **97**
- Martha Matilda (1821-1866) .. 188
- Martin Van Buren (1836-1903) 232, **235**
- Mary (1770-1866)20, 21, **29, 30, 31, 32, 212, 213, 215**
- Mary (1791-1821) 28, 29, **144**
- Mary Ann (1804-1899).. 160, **161**
- Mary Ann (1805-1839)..... 37, 38, **231**
- Mary Ann (1819-1889).. 168, **173**
- Mary Ann (1835-)..... 55, 56, **281**
- Mary Ann (1841-1880).. 242, **244**
- Mary Ann (1843-1844).. 232, **237**
- Mary E "Polly" (1830-1916) .. 140, **142**
- Mary E (1814-1860) **149**
- Mary E (1844-1875) 224, **225**
- Mary Eliza (1836-)..... 191, **194**
- Mary Elizabeth (1876-) . 290, **291**
- Mary Maria (1800-1811) ... 92, **93**
- Melanthe (1816-) 136, **138**
- Melissa (1798-)..... 90, **91**
- Miles (1798-1870)..... 168, **170**
- Millicent (1786-1868) 74, 76, **165**
- Nancy (1800-1883) 95, **97**
- Naomi (1764-1846) .. 69, 70, **116**
- Naomi (1802-1844)..... 123
- Nathan (1768-1838). 74, 76, **151**
- Nathan (1859-1925)..... 244, **249**
- Nelson (1798-1881) 95, **96**
- Odell Marvin (1815-1892) 124, **127**
- Oliver Williams (1845->1916) 232, **237**
- Patty (1806-1876) 102, **103**
- Patty Maria (1817-)..... 168, **172**
- Peter H (1800-1870) 123
- Phebe (1796-1864) 18, **19**
- Phebe (1823-) 34, **35**
- Philip (1759-1831) 63, 65, **84**
- Phillip (1812-1885) 102, **104**
- Polly (1777-) 63, 66, **105**
- Polly (1796-) 90, **91**
- Polly (1827-1897) 108, **111**
- Polly (1830-4713 BC) 57, 58, **286**
- Polly Hubby (1806-) 92, **93**
- Polly M (1800-1873). 78, 81, **195**
- Polly Matilda (1805-1853) 168, **171**
- Rebecca (1750-1842) 59, 61, **77, 167**
- Roxanna (1805-1875)... 123, **124**
- Rufus (1802-1866)... 23, 25, **209**
- Rufus (1819-1876)..... 197, **198**
- Ruhamah (1796-1878) 23, 24, **207**
- Ruhamah (1801-1868) 15, **51, 259, 260, 261, 262, 264, 265, 266, 268, 269**
- Ruhamah (1817-) 122
- Ruth (1786-) 114, **115**
- Sally (1788-1858)..... 114, **115**
- Sally (1810-)..... 102, **104**
- Sally (1815-)..... 136, **138**
- Sally B (1792-)..... 71, 73, **148**
- Samuel (1852-1875) 244, **247**
- Samuel H (1808-1881) . 106, **108**
- Sarah (1732-1810) ... 59, 61, **66, 67, 111, 112**
- Sarah (1734-).. **69, 70, 114, 116, 119, 121, 122, 123, 124, 125, 128**
- Sarah (1767-1860) .. 69, 70, **119**
- Sarah (1816-1886) 108, **110**
- Seth (1736-1809)59, 61, **69, 114, 116, 119, 121, 122, 123, 124, 125, 128**
- Seth (1751-1790) 168, 169
- Seth A (1810-1880) 123, **124**
- Seth Jr (1769-1819) 69, 70, **121, 122, 123**
- Silas (1661-1732) 18, 20, 59, 63, 66, 68, 69, 71, 73, 74, 77, 78
- Silas (ca.1641-1697/98) 59
- Smith (1792-1862) 114, **116**
- Smith (1841-)..... 135
- Sophia (1784-1869) . 71, 73, **143**
- Sophia (1829-1913) . 57, 58, **284**
- Sophonra (1817-)..... 152, **153**
- Sophy (1801-1801)..... 102, **103**
- Sophy (1804-1826) 15
- Spencer L (1847-<1920)224, **225**
- Stephen (1710-1736)69, 70, 114, 116, 119, 122, 123, 124, 128

- Stephen Gregory (1798-1868)
..... 124, **125**
- Susanna (1766-) 20, 21, **28**, 144,
145
- Susanna (1793-1808)..... 33
- Susannah (1814-1830)..... 122
- Susie (1816-1886)..... 144, **145**
- Tamma (1795-1864)..... 33, **217**
- Thankful (1734-1772) 59, 61, **68**,
113
- Thankful (1775-1808)69, 71, **128**
- Theodore Crosby (1828-1898)
..... 191, **192**
- Thirza (1772-1862)...74, 76, **154**
- Thirza (1779-1861)...78, 80, **168**
- Thomas..... 91
- Thomas (1745-1804)..59, 61, **71**,
130, 133, 135, 136, 139, 140,
143, 144, 146, 147, 148
- Thomas (1804-1850).... 136, **137**
- Thomas (1836-1906).... 140, **143**
- Thomas Baldwin (1773-1855). 71,
72, **133**
- Thomas Baldwin (1789-1871)130,
131
- William (1775-1864)**168**, **169**
- William (1827-) 227, **228**
- William (ca.1802-1874) 152, **153**
- William Anson (1813-1883)94, **95**
- William Henry (1830-).. 191, **193**
- Wilson "Willie" (1876-1928) . 272,
279
- Zachariah (1778-1865).... 63, 66,
105, **106**, **108**
- Zachariah P (1804-1900).. 95, **97**
- Zachariah Paddock (1806-1888)
..... 106, **107**
- Sears**
Eunice P (1804-).....**93**
- Sears**
Isabell.....**94**
- Sears**
Isabell.....**94**
- Sears**
Polly (1814-).....**124**
- Sears**
Phebe (1817-).....**135**
- Sears**
Phebe (1817-).....**135**
- Sears**
Sybil.....**151**
- Sears**
Sybil.....**152**
- Sears**
Roxana.....**152**
- Sears**
Roxana.....**152**
- Sears**
Mary (ca.1807-).....**172**
- Sears**
Ruth (1792-1876).....**201**
- Sears**
Ruth (1792-1876).....**201**
- Sears**
Henrietta Margaret (1830-1892)
.....**202**
- Sears**
Prudence M (1834-1860)**206**
- Sears**
Sally A (1821-1872).....**228**
- Sears**
Isabella (1870-).....**247**
- Sellick**
Jesse (1772-)..... 140, 142
Polly (1798-1868)..... **140**, **142**
- Shaw**
Charles (1812-).....**289**
Elsie Sears (1875-)..... 289
Heman D (1872-1941) 289
- Shearer**
Alexander (1786-1845)**88**
- Shearston**
Edward 291
William R (1864-1934) **291**
- Sheldon**
Hannah "Betsy" (1807-) **138**
- Shepardson**
Laurilla (1818-1850)**172**
Pliny (1796-1871)..... 172
- Shepardson**
Rachel (1798-1864) 172
- Sherman**
Hannah 197, 198
- Sherwood**
Abel Sears (1823-1902) ...51, 53,
259
Angeline (1844-1914)51, 54, **269**
Edie (1877-1974) 265, **267**
Edward 260, **261**
Elam G (1827-1912) .51, 53, **260**
Elon (Elam G. Sherwood) (1827-
1912) 53, 260
George..... 261, **263**
George C (1861-1931) . 261, **263**
Grace..... 264
Harry 264
Hellen G (ca.1827-) 51, **53**
Herbert Leon (1863-1931) ... 265,
267
James Launey (1838-1914)51, **54**
Jehiel 136
John 260, **261**
John (1834-1909)..... 51, 53, **264**
Jones Ebenezer (1831-1864).. 51,
53, **261**
Lewis Hibbard (1859-1862).. 261,
263
Lincoln 260
Marcia..... 264
Mary 261, **263**
Mary Celinda (1857-1939) ... 261,
263
- Mary E (1839-1841).. 51, 54, **268**
May (1866-1872).....265, **267**
Mehitabel S (1776-1824)..... **136**
Myron (1836-1904)... 51, 53, **265**
Noah Schuyler (1786-1873)... **51**,
52, 259, 260, 261, 262, 264,
265, 268, 269
Noel264
Ora A "Orrie" (1856-1925)....261,
262
Susie268
- Siemdorf**
Anna Mary (ca.1882-1959) ... **281**
- Smith**
(1760-) **114**, **115**
(unknown given name) ..284, **286**
Amanda Maria (1804-1876) ..128,
129
Ammi (1824-1909) **284**, **285**
Betsy (1784-1869) ..**41**, **42**, 242,
244, 245
Esther.....111
Jane Elizabeth (1824-1904) .. **199**
Jeremiah 114, 115
Job (1758-)..... 41, 42, 242, 244
Nathaniel (1799-1855)..128, **129**
Orrin Gazebe (1797-1880)....128,
129
Oscar H (1865-)284, **286**
Richard (1744-).....128
Roswell (1830-)..... **142**
Seth (1795-1801).....128, **129**
Seth Sears (1806-1884) 128, **130**
Silas (1801-1880).....128, **129**
Silas P (1851-1896).....284, **285**
Susan A (1829-)..... **190**
Susan Frances (1785-1849) ...184
William199
William (1770-1857) **128**
- Somers**
Easter Hester (1823-1859) ... **145**
Thomas.....145
- Spalding**
Emily Cozzens (1838-1918) .**265**,
266
Lucius Wells (1832-) **237**
Moses237
- Spencer**
Gideon Jr (1774-)130
Lucy (1801-)..... **118**
Norman (1800-1872) **129**
- Spinney**
Elizabeth **166**
- St. Douglass**
Mills (1834-) **225**
- St. John**
James (1800-1882) **240**
Lucy Ann (1826-1907) ..240, **241**
- Stearns**
Oliver (1742-) 90
Priscilla (1768-1799)..... **90**
- Stevens**
Catherine **218**

Forward (1766-).....	31, 32		
Stewart		--Townsend	
Rebecca.....	120	Hannah.....	33
Strong		--Townsend	
Alonzo.....	290, 291	Hannah.....	217
Marcena Sylvania.....	290, 291	--Townsend	
Sweet		Hannah.....	219
Hannah (1835-1919) ...	272, 273	Tracy	
Sylvester.....	272, 273	Gordon.....	256
Tabor		Tuttle	
Clarissa (1801-).....	230	LaVerne (1848-1918)	283
Ziba.....	230	Tyler	
Tallman		Sally Maria (1823-1890)	105
Sarah (1809-1876).....	158	Underhill	
Tarbox		Charles Munson.....	250
Shirley.....	137	Upson	
Taylor		Hannah.....	199
Mary F (1844-1880).....	247	Vail	
Thacher		Mary.....	215
Martha (1815-1887)	109	Sarah (1816-1869).....	214
Timothy.....	109	Van Valkinburgh	
Tobey		Lavina (1805-1880).....	153
Desire (1707-1781)14, 15, 17, 18,		van Wagoner	
20, 23, 25, 28, 30, 31, 33, 34,		Clara (-1923).....	288, 289
36, 37, 38, 39, 41, 43, 44, 46,		Kittie (1859-1934).....	288
59, 60, 63, 64, 66, 67, 68, 69,		Morgan (-1864).....	288
71, 73, 74, 77, 78, 79, 83, 84,		Vincent	
87, 90, 91, 92, 94, 95, 100, 102,		Mary (1672-1776).....	63
105, 106, 108, 111, 112, 113,		Volkingburgh	
114, 116, 119, 122, 123, 124,		Lavina (Lavina Van Valkinburgh)	
128, 130, 133, 135, 136, 139,		(1805-1880).....	153
140, 143, 144, 147, 148, 150,		Walbridge	
151, 152, 154, 155, 160, 163,		Caroline Scott (1835-1909) ..	252
165, 167, 168, 174, 176, 177,		Walker	
178, 179, 180, 186, 188, 191,		Edward F.....	254
195, 213		Warin	
Thomas III (1676-)18, 20, 59, 60,		Catharine (1767-1860) ...	23, 24,
63, 66, 68, 69, 71, 73, 74, 77,		197, 201, 203, 207, 209, 210,	211
78		Warner	
Towner		Harriet Elizabeth (1832-1913)	
Emma C.....	142	184
Townsend		John (1806-).....	185
Amanda M (1811-)	209, 210	Matilda.....	211, 212
Isaac (1766-).....	31	Susan S (1778-).....	130
Mary (1772-1819) ..	33, 217, 219	--Warner	
Susanna (1740-1782) 13, 14, 15,		Susan (1810-).....	185
20, 23, 25, 28, 29, 30, 31, 32,		Warren	
33, 34, 35, 36, 37, 38, 39, 41,		Abigail (1807-).....	235
49, 51, 55, 57, 144, 197, 201,		Washburn	
203, 207, 209, 210, 211, 213,		Frederick (1815-).....	99
215, 217, 219, 224, 227, 230,			
231, 232, 239, 240, 242, 244			
Uriah.....	33, 217, 219		
--Townsend			
Hannah.....	33		
		Washer	
		John (1786-1771)	159
		Waterman	
		Caroline.....	218
		Waters	
		Adam (1779-).....	162
		Mary Ann (1805-1887)	162
		Weed	
		James (1783-1814).....	177
		James Orville (1814-) ...	177, 178
		Joseph Oscar (1812-) ...	177, 178
		Levi D.....	214
		West	
		Erastus Robert (1804-1884) .	158
		Peter.....	158
		--West	
		Prudence.....	158
		Westcott	
		Betty (1747-).....	176
		Wheaton	
		Sarah (1806-1846)	89
		Whitaker	
		(unknown given name).....	111
		White	
		Charity (1792-1883).....	179
		Wilcox	
		Emily Hopkins (1831-1859) ..	205
		Harriet Amelia.....	205
		Wille	
		Lorenzo S (1860-1935).....	283
		Williams	
		Cynthia Marie (1810-1885) .	232,
		233	
		Henrietta.....	219
		Horace (1799-1856).....	123
		Joseph Jr (1768-1856).....	124
		Oliver.....	232, 233
		Wilson	
		Henry O (1875-1963)	289
		Wren.....	263
		Wood	
		Denniston L (1870-1957)	279
		Sabra (1830-).....	258
		Woods	
		Polly (1780-1858)	14
		Woodworth	
		Phoebe (1776-1856).....	132
		Wright	
		John (1819-).....	184
		Young	
		Archibald (1780-).....	143
		Ezra (1788-).....	148
		Thomas Sears (1813-1904) ...	148